

MONORACK SPECIFICO - SPECIFIC MONORACK
MONORACK SPECIFIQUE - SPEZIFISCHES MONORACK - MONORACK ESPECÍFICO

KAWASAKI ER-6n '05/'08

ISTRUZIONI DI MONTAGGIO - MOUNTING INSTRUCTIONS
INSTRUCTIONS DE MONTAGE - BAUANLEITUNG - INSTRUCCIONES DE MONTAJE

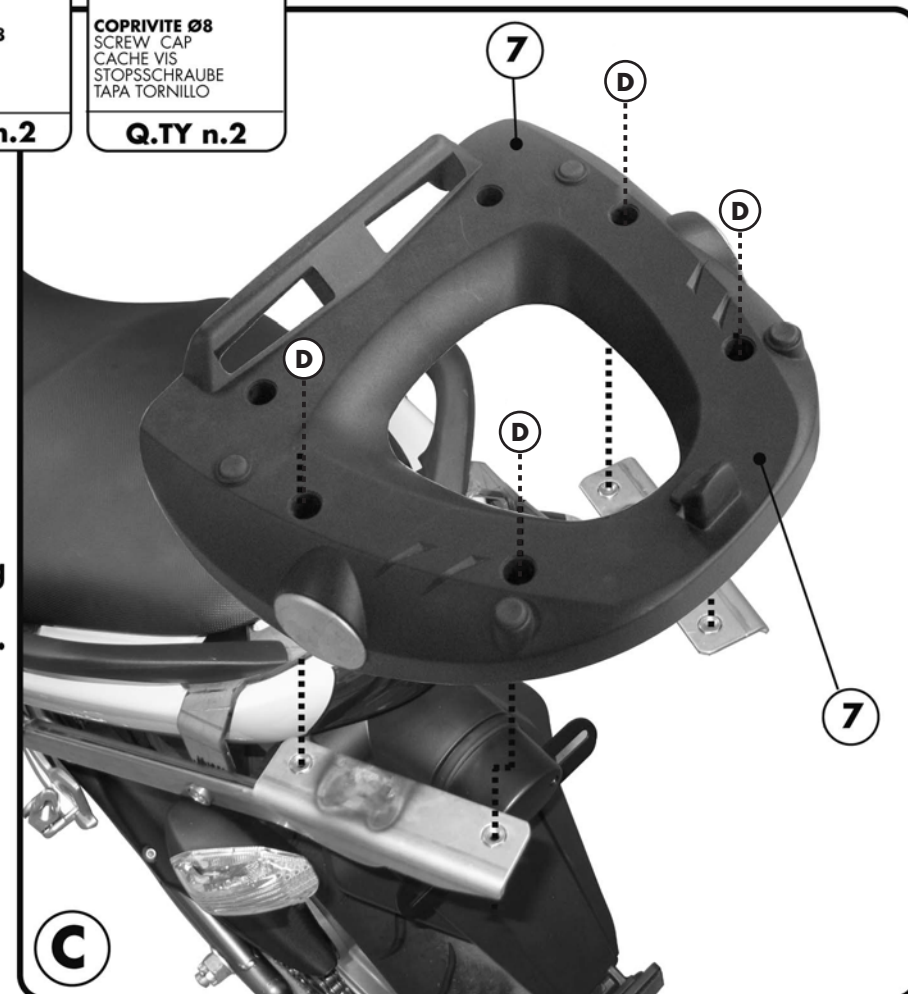
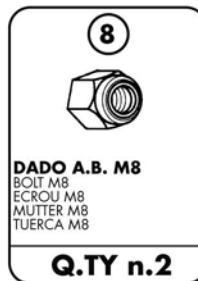
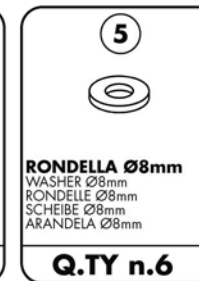
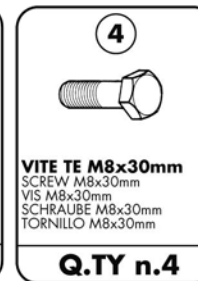
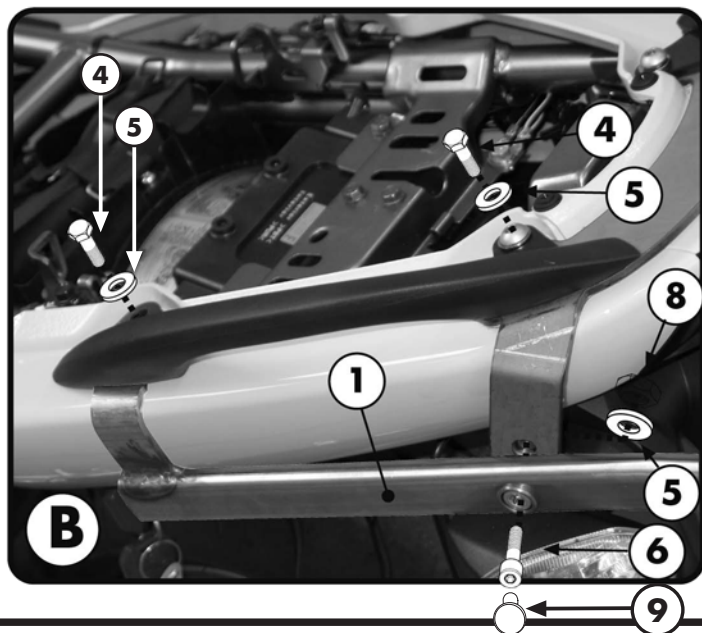
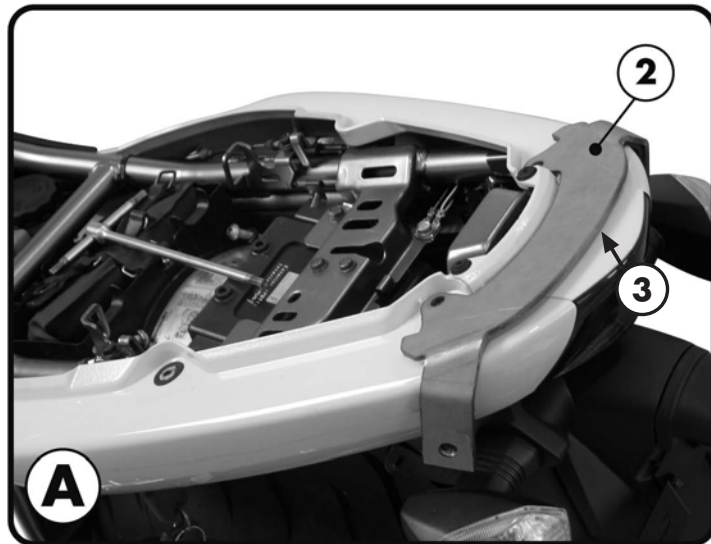

ATTENZIONE: CARICO MASSIMO, 6Kg.
WARNING: MAX LOAD, 6Kg.
ATENCIÓN: CARGA MÁXIMA, 6Kg.
ACHTUNG: MAX, 6Kg.
¡ATENCIÓN! CARGA MÁXIMA, 6Kg.

MONORACK SPECIFICO - SPECIFIC MONORACK
 MONORACK SPECIFIQUE - SPEZIFISCHES MONORACK - MONORACK ESPECÍFICO

KAWASAKI ER-6n '05/'08

ISTRUZIONI DI MONTAGGIO - MOUNTING INSTRUCTIONS
 INSTRUCTIONS DE MONTAGE - BAUANLEITUNG - INSTRUCCIONES DE MONTAJE

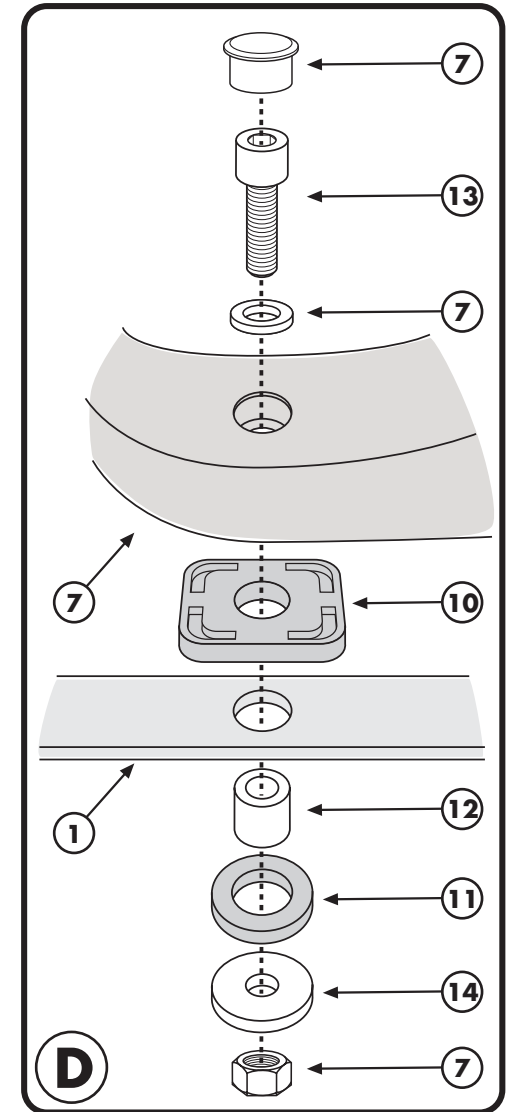
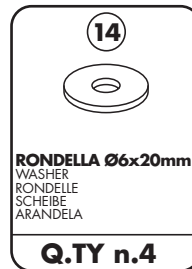
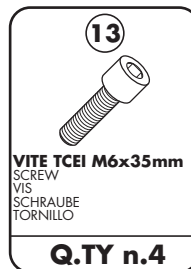
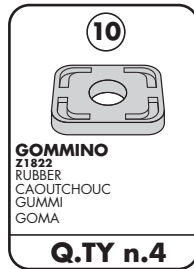

MONORACK SPECIFICO - SPECIFIC MONORACK
MONORACK SPECIFIQUE - SPEZIFISCHES MONORACK - MONORACK ESPECÍFICO

KAWASAKI ER-6n '05/'08

ISTRUZIONI DI MONTAGGIO - MOUNTING INSTRUCTIONS
INSTRUCTIONS DE MONTAGE - BAUANLEITUNG - INSTRUCCIONES DE MONTAJE

I ISTRUZIONI DI MONTAGGIO

- SMONTARE LE MANIGLIE ORIGINALI DELLA MOTO;
- INCOLLARE LA MOUSSE ADESIVA SULLA PARTE DEL SUPPORTO "2" CHE VA A CONTATTO CON LA CARENATURA DELLA MOTO;
- POSIZIONARE IL SUPPORTO "2" COME INDICATO IN FIGURA "A";
- POSIZIONARE LE STAFFE MONORACK E SEGUIRE IL MONTAGGIO PROPOSTO IN FIGURA "B".
- CONTROLLARE CHE TUTTE LE VITI SIANO SERRATE BENE.

GB MOUNTING INSTRUCTIONS

1. REMOVE THE ORIGINAL HANDLE BARS;
2. PLACE THE SUPPORT N° 2 AS SHOWN IN PICTURE A, STICKING THE PROTECTIVE RUBBER PADS ONTO THE SUPPORT WHERE IT COMES INTO CONTACT WITH THE FARING;
3. POSITION THE MONORACK ARMS AND CARRY OUT THE MOUNTING INSTRUCTIONS SHOWN IN PICTURE B;
4. LASTLY CHECK THAT ALL SCREWS HAVE BEEN TIGHTENED.

F INSTRUCTIONS DE MONTAGE

- DEMONTER LES POIGNEES PASSAGER D'ORIGINE DE LA MOTO ;
COLLER LA MOUSSE ADHESIVE SUR LA PARTIE DU SUPPORT N°2 QUI SERA EN CONTACT AVEC LA CARROSSERIE DE LA MOTO;
POSITIONNER LE SUPPORT N°2 COMME INDIQUE EN PHOTO A ;
POSITIONNER LES BRAS DU MONORACK ET FAIRE LE MONTAGE PROPOSE EN PHOTO B ;
CONTROLLER LE BON SERRAGE DE TOUTES LES VIS ;

D BAUANLEITUNG

- ENTFERNEN SIE DIE ORIGINAL HANDGRIFFE DES FAHRZEUGS;
KLEBEN SIE DEN SCHUTZGUMMI AUF DIE HALTERUNG NR. 2, DIE DIE VERKLEIDUNG DES FAHRZEUGES BERÜHRT;
POSITIONIEREN SIE DIE HALTERUNG NR. 2 WIE IM BILD
A BESCHRIEBEN;
POSITIONIEREN SIE DIE MONORACK ARME UND FOLGEN SIE DER MONTAGEANLEITUNG VOM BILD B;
ZULETZT ÜBERPRÜFEN SIE, DASS ALLE SCHRAUBEN FESTGEZOGEN WURDEN.

ES

INSTRUCCIONES DE MONTAJE

1. DESMONTAR EL ASA ORIGINAL DE LA MOTO;
2. ENCOLAR LA CAPA ADHESIVA SOBRE LA PARTE DEL SOPORTE 2 AL CARENADO TRASERO;
3. POSICIONAR EL SOPORTE N. 2 COMO INDICA LA FOTO A;
4. POSICIONAR LOS BRAZOS DEL MONORACK Y SEGUIR EL MONTAJE ILUSTRADO EN LA FIGURA B;
5. CONTROLAR QUE TODA LA TORTILLERIA HA SIDO BIEN APRETADA.