

PLX3125 - KLX3125

PORTAVALIGIE LATERALE SPECIFICO - SPECIFIC TUBULAR SIDE-CASE HOLDER - PORTE-VALISES LATÉRAUX SPÉCIFIQUE
SPEZIFISCHES STAHLROHR-SEITENTRAEGER - PORTA MALETAS LATERALES ESPECÍFICO - SUPORTE DE MALAS ESPECÍFICO

SUZUKI V-STROM 800DE (2023)

N°	Descrizione/Description	Caratteristiche/Features	Codice/Code	Quantità/quantity
1	Telaio laterale - Side frame - Châssis latéral Soporte lateral - Seitenrahmen - Suporte lateral	-	PLX3125DXV PLX3125SXV	2 (Right: Left)
2	Supporto anteriore - Front support - Support avant Vordere Unterstützung - Soporte frontal - Suporte frontal	-	GL5600SXV GL5600DXV	2 (Right: Left)
3	Supporto superiore - Support higher - Support supérieur Halterung höher - Soporte superior - Apoio superior	-	GL5601PV	2
4	Supporto posteriore - Rear support - Hintere Unterstützung Support arrière - Soporte trasero - Suporte traseiro	-	GL5602DXV GL5602SXV	2 (Right: Left)
5	Vite - Screw - Vis - Schraube Tornillo - Parafuso	TBEI M8x45	845TBEI	2
6	Vite - Screw - Vis - Schraube Tornillo - Parafuso	TBEI M8x35	835TBEI	2
7	Vite - Screw - Vis - Schraube Tornillo - Parafuso	TCE M8x35	835TCE	4
8	Vite - Screw - Vis - Schraube Tornillo - Parafuso	TBEI M8x25	825TBEI	6
9	Vite - Screw - Vis - Schraube Tornillo - Parafuso	TBEI M6x35	635TBEI	2
10	Vite - Screw - Vis - Schraube Tornillo - Parafuso	TBEI M6x20	620TBEI	2
11	Rondella spaccata - Split washer Scheibe - Rondelle fendue Arandela seccionada - Arruela Dentada	Foro Ø8mm	Z1060	8
12	Rondella spaccata - Split washer Scheibe - Rondelle fendue Arandela seccionada - Arruela Dentada	Foro Ø6mm	Z1063	4
13	Rondella - Washer - Rondelle - Scheibe Arandela - Arruela	Foro Ø8mm / Esterno Ø20mm Sp.2mm	820RON	12
14	Rondella - Washer - Rondelle - Scheibe Arandela - Arruela	Foro Ø8mm	8RON	6
15	Rondella spaccata - Split washer Scheibe - Rondelle fendue Arandela seccionada - Arruela Dentada	Foro Ø6mm / Esterno Ø18mm	618RON	4
16	Distanziale - Spacer - Entretoise - Distanzstueck Distanciador - Espaçado	Ø18x11 Foro 8,3mm	C18L11F8.3T	4
17	Dado - Bolt - Ecrou Mutter - Tuerca - Porca	Dado Autobloccante Flangiato M8 (H.9,5mm)	8DADIFN	6
18	Componenti Originali - Original Parts Parties Originales - Original Bauteile Componentes Originales - Componentes Originais	-	-	-
19	Particolari Inclusi nel 02RKIT Components Included In The 02RKIT Pièces Incluses Dans 02RKIT Die Einzelnen Teile Sind Bei 02RKIT Despieces Incluidos 02RKIT Componentes incluidos na 02RKIT	-	-	-

PLX3125 - KLX3125

PORTAVALIGIE LATERALE SPECIFICO - SPECIFIC TUBULAR SIDE-CASE HOLDER - PORTE-VALISES LATÉRAUX SPÉCIFIQUE
SPEZIFISCHES STAHLROHR-SEITENTRAEGER - PORTA MALETAS LATERALES ESPECÍFICO - SUPORTE DE MALAS ESPECÍFICO

SUZUKI V-STROM 800DE (2023)

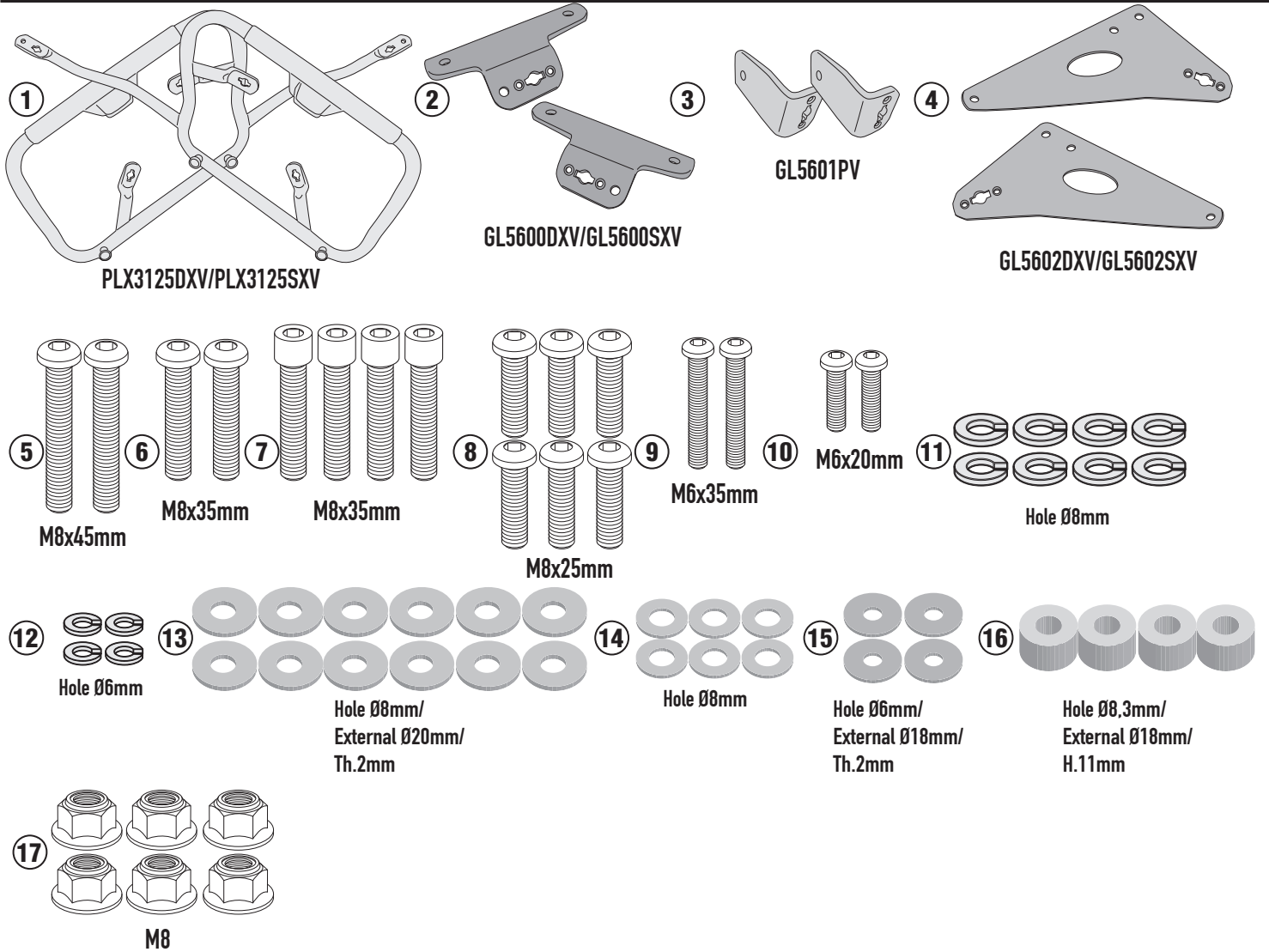

IT_ Nel caso in cui sulle viti originali sia presente del frenafili, ripristinarlo durante il montaggio dell'accessorio.

EN_ If there is threadlocker on the original screws, use threadlocker when mounting the accessory.

DE_ Falls sich auf den Originalschrauben Schraubensicherungsklebstoff befand, sollte dieser auch bei der Montage des Zubehörs wieder aufgetragen werden

FR_ Si du frein filet est présent sur les vis d'origine, l'appliquer également lors du montage de l'accessoire

ES_ En caso de que el fijador de roscas se encuentre presente en los tornillos originales, colocarlo nuevamente en el montaje del accesorio

PT_ Se houver trava rosca nos parafusos originais, inserir novamente durante a montagem do acessório

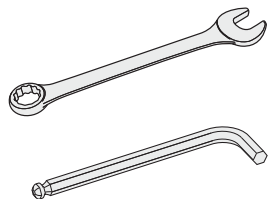
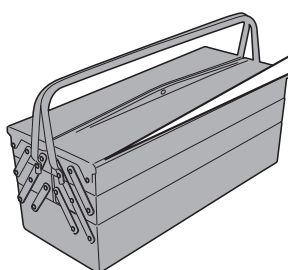

13mm

4mm / 5mm / 6mm



CHECK THE SCREW LENGTH HERE

mm

ISTRUZIONI DI MONTAGGIO - MOUNTING INSTRUCTIONS
INSTRUCTIONS DE MONTAGE - BAUANLEITUNG
INSTRUCCIONES DE MONTAJE - INSTRUÇÕES DE MONTAGEM

PLX3125 - KLX3125

PORTAVALIGIE LATERALE SPECIFICO - SPECIFIC TUBULAR SIDE-CASE HOLDER - PORTE-VALISES LATÉRAUX SPÉCIFIQUE
SPEZIFISCHES STAHLROHR-SEITENTRAEGER - PORTA MALETAS LATERALES ESPECÍFICO - SUPORTE DE MALAS ESPECÍFICO

SUZUKI V-STROM 800DE (2023)

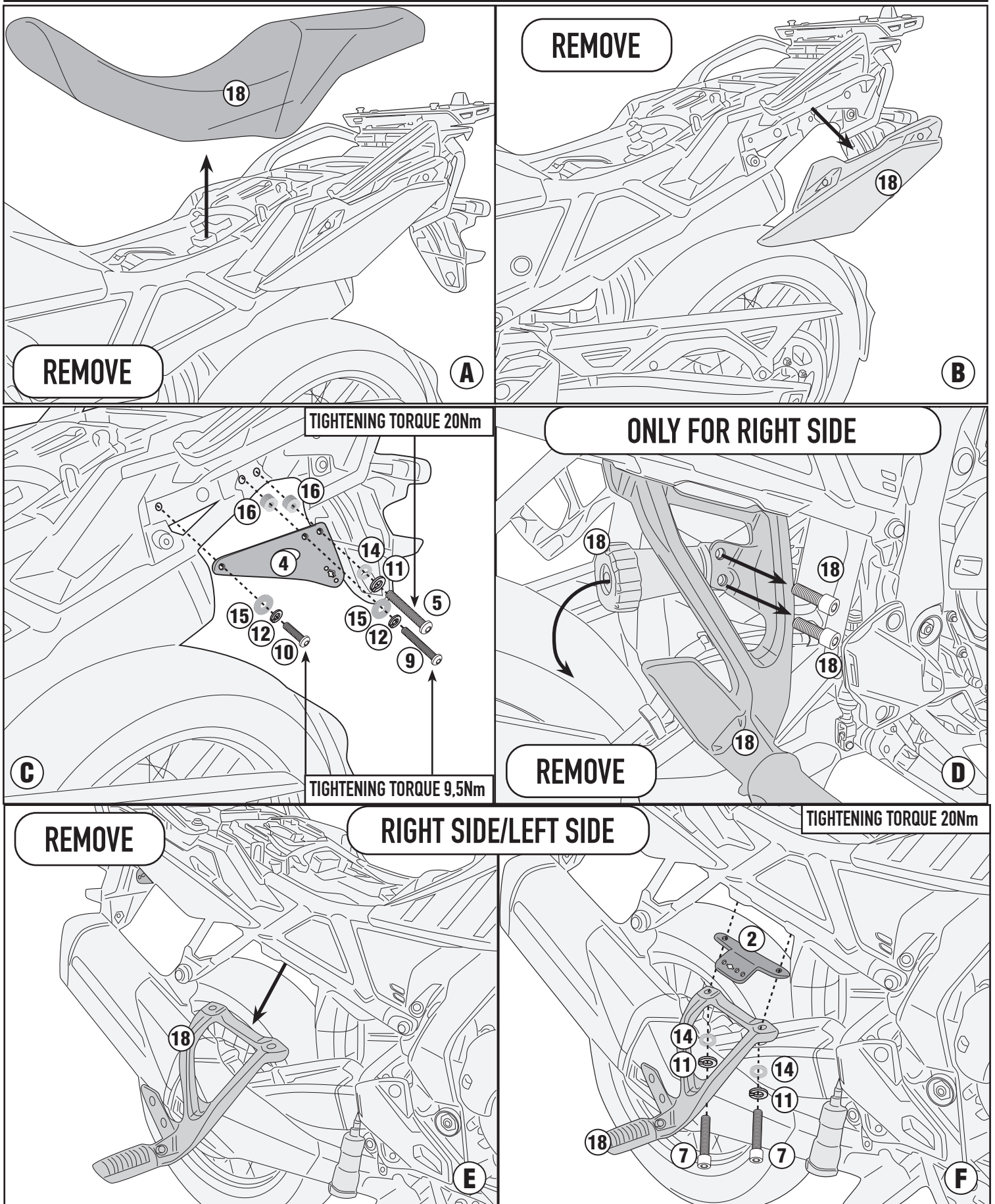

PLX3125 - KLX3125

PORTAVALIGIE LATERALE SPECIFICO - SPECIFIC TUBULAR SIDE-CASE HOLDER - PORTE-VALISES LATÉRAUX SPÉCIFIQUE
SPEZIFISCHES STAHLROHR-SEITENTRAEGER - PORTA MALETAS LATERALES ESPECÍFICO - SUPORTE DE MALAS ESPECÍFICO

SUZUKI V-STROM 800DE (2023)

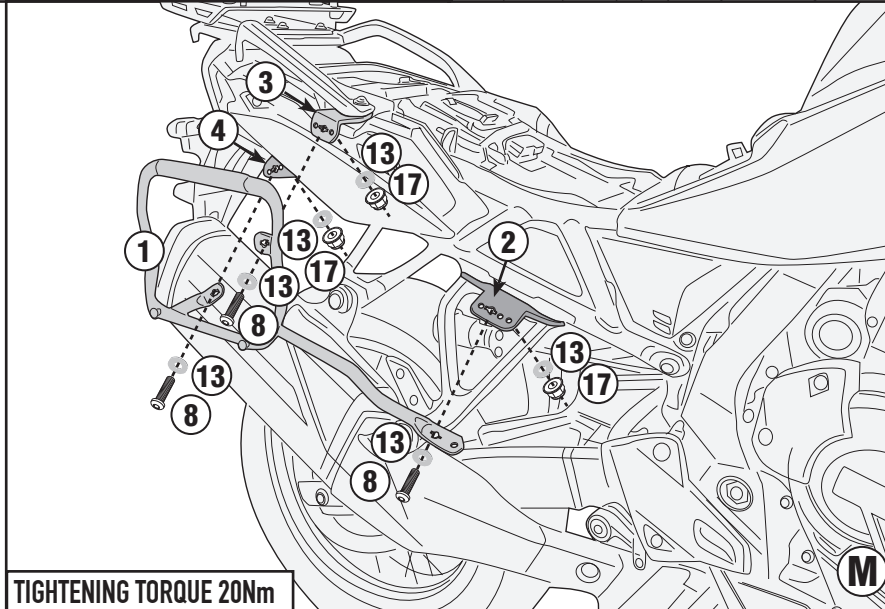
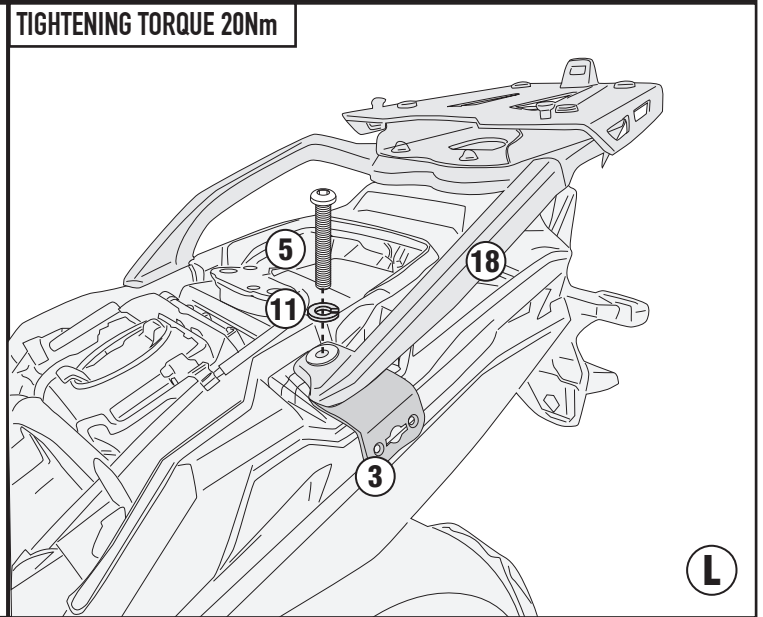
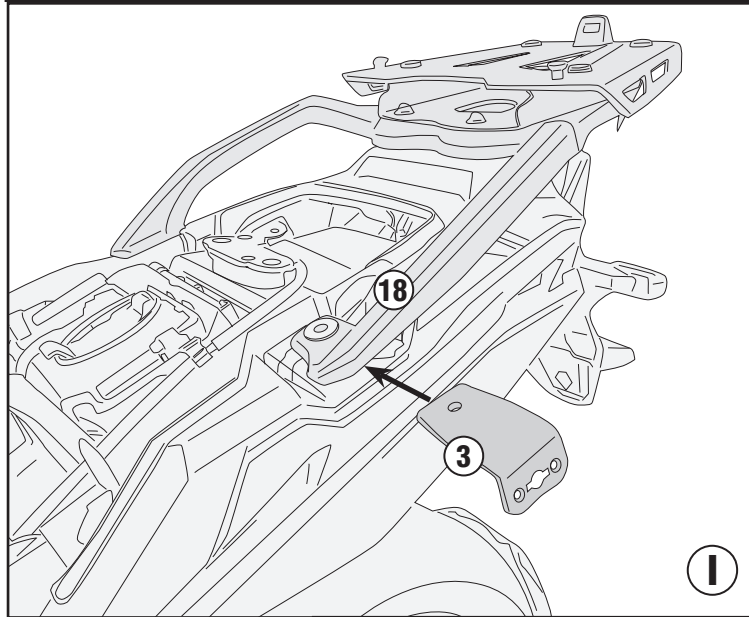
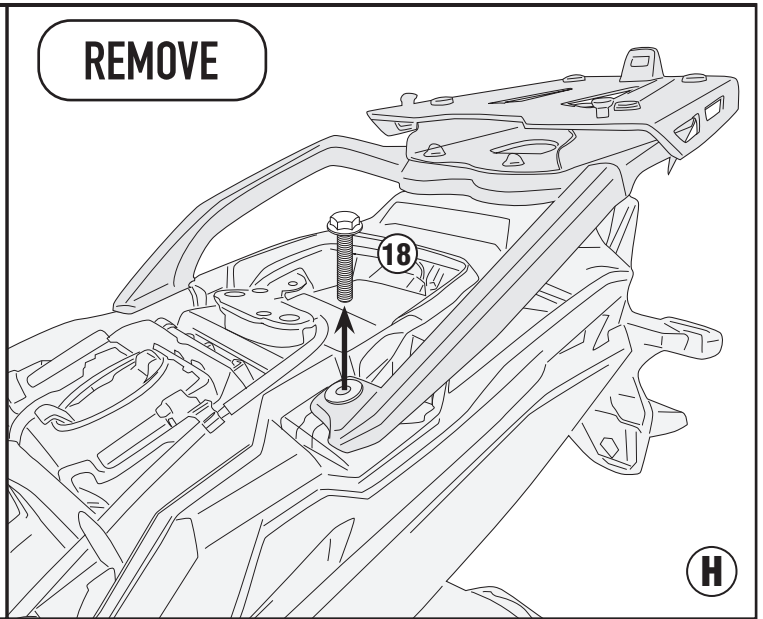
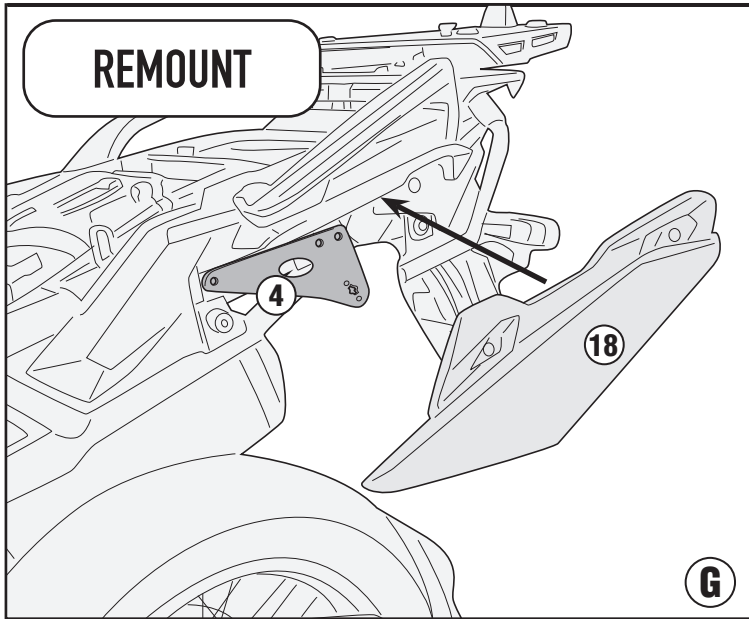

TIGHTENING TORQUE 20Nm

ISTRUZIONI DI MONTAGGIO - MOUNTING INSTRUCTIONS
INSTRUCTIONS DE MONTAGE - BAUANLEITUNG
INSTRUCCIONES DE MONTAJE - INSTRUÇÕES DE MONTAGEM

PLX3125 - KLX3125

PORTAVALIGIE LATERALE SPECIFICO - SPECIFIC TUBULAR SIDE-CASE HOLDER - PORTE-VALISES LATÉRAUX SPÉCIFIQUE
SPEZIFISCHES STAHLROHR-SEITENTRÄGER - PORTA MALETAS LATERALES ESPECÍFICO - SUPORTE DE MALAS ESPECÍFICO

SUZUKI V-STROM 800DE (2023)

- TRASFORMAZIONE IN PORTAVALIGIE LATERALI RAPID FITTING, AGGIUNDO IL KIT 02RKIT (DA ACQUISTARE SEPARATAMENTE)
- TRANSFORMATION INTO A RAPID FITTING SIDE-CASE HOLDER, BY ADDING THE 02RKIT KIT (TO BE PURCHASED SEPARATELY)
- VERARBEITUNG ZU EINEM SCHNELL MONTIERBAREN SEITENTRÄGER UNTER HINZUFÜGUNG DES 02RKIT-KITS (SEPARAT ZU ERWERBEN)
- TRANSFORMABLE EN KIT DE FIXATION LATÉRAL RAPIDE, EN AJOUTANT LE KIT 02RKIT (À ACHETER SÉPARÉMENT)
- SE TRANSFORMA EN UN PORTAMALETAS LATERAL DE AJUSTE RÁPIDO, AÑADIENDO EL KIT 02RKIT (SE COMPRA POR SEPARADO)
- CONVERTE EM UM RACK DE PAINEL LATERAL DE ENCAIXE RÁPIDO, ADICIONANDO O KIT 02RKIT (ADQUIRIDO SEPARADAMENTE)



ALWAYS MOUNT THE SCREWS FROM
THE OUTSIDE OF THE FRAME

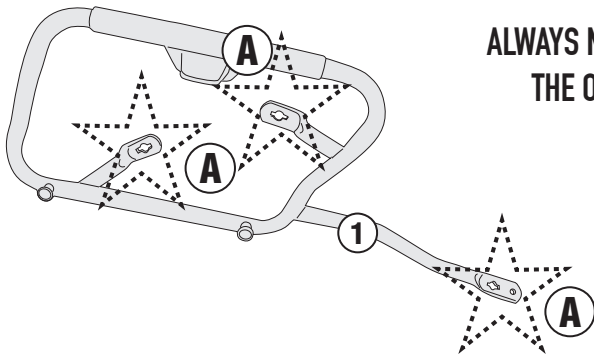

(See the figure above for the correct type)

CORRECT SIDE

INSERT
ATTENTION TO THE
CORRECT ASSEMBLY

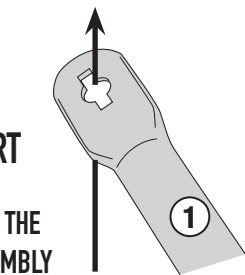

19
INSERT



ATTENTION TO THE
CORRECT ASSEMBLY

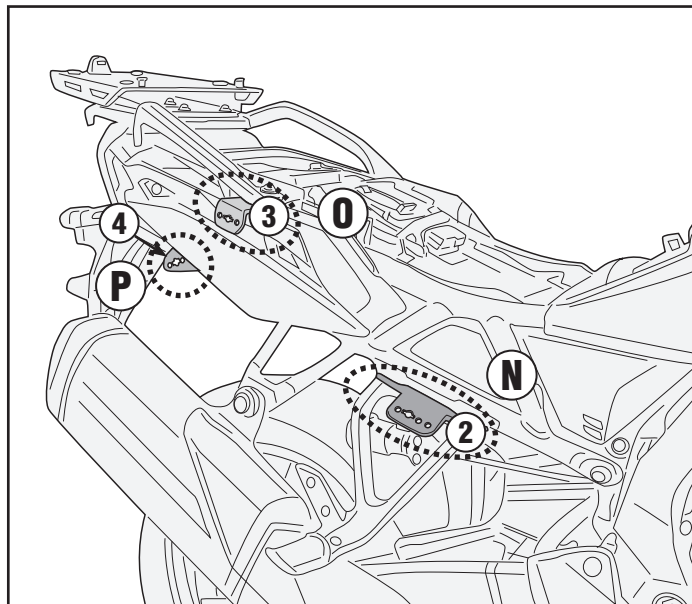
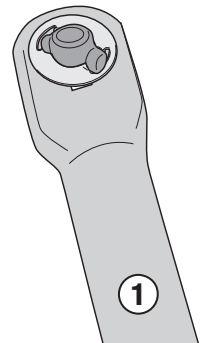
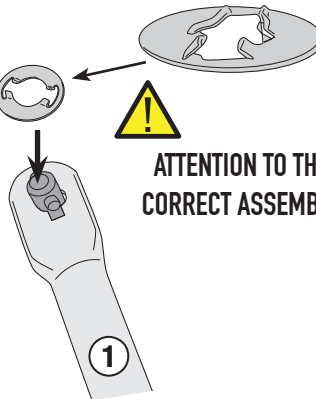

ISTRUZIONI DI MONTAGGIO - MOUNTING INSTRUCTIONS
INSTRUCTIONS DE MONTAGE - BAUANLEITUNG
INSTRUCCIONES DE MONTAJE - INSTRUÇÕES DE MONTAGEM

PLX3125 - KLX3125

PORTAVALIGIE LATERALE SPECIFICO - SPECIFIC TUBULAR SIDE-CASE HOLDER - PORTE-VALISES LATÉRAUX SPÉCIFIQUE
SPEZIFISCHES STAHLROHR-SEITENTRAEGER - PORTA MALETAS LATERALES ESPECÍFICO - SUPORTE DE MALAS ESPECÍFICO

SUZUKI V-STROM 800DE (2023)

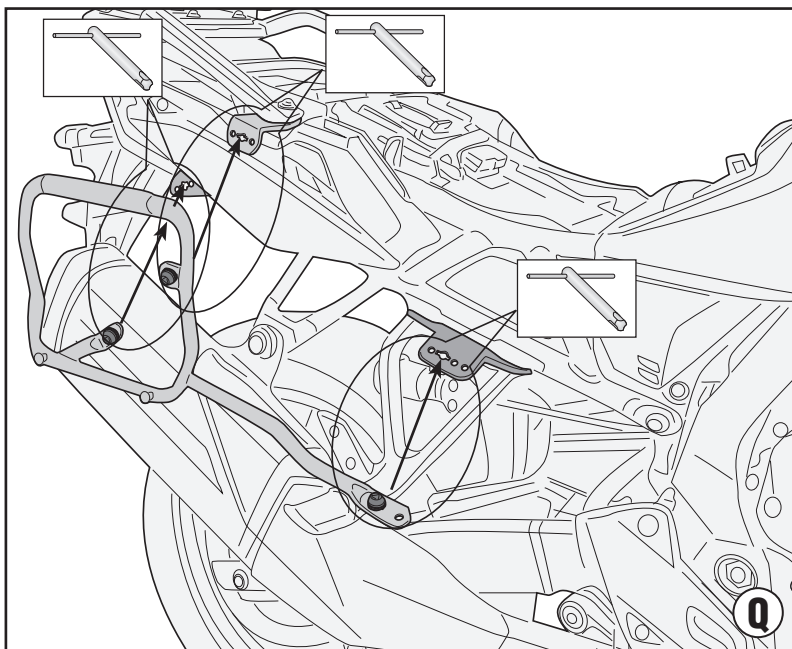
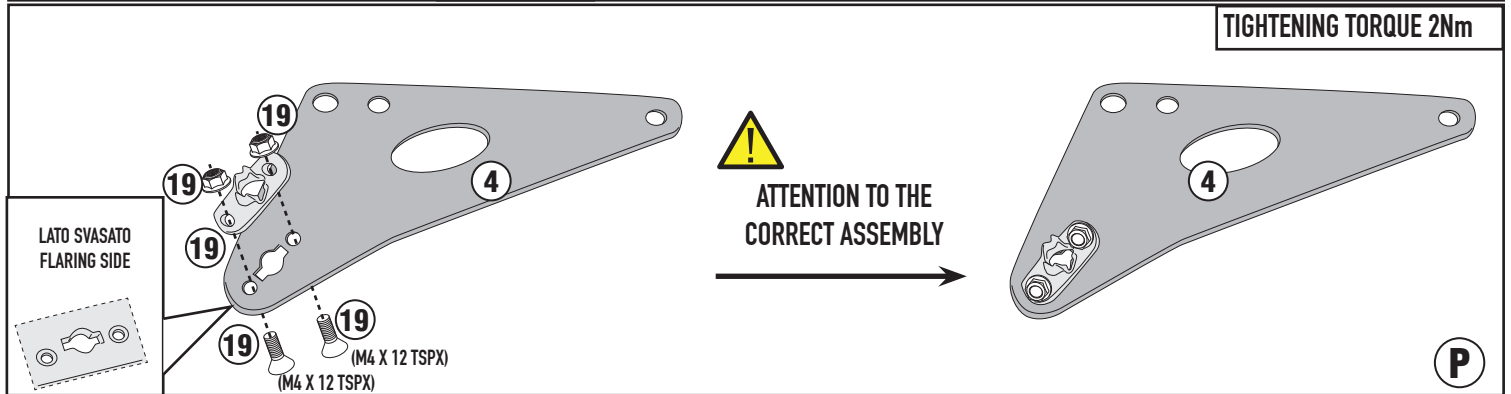
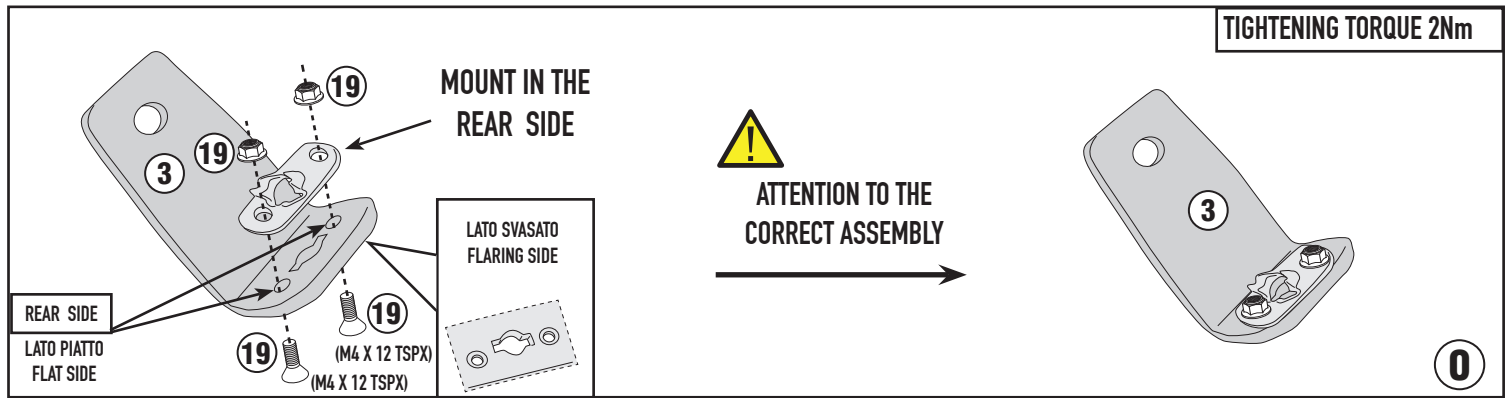
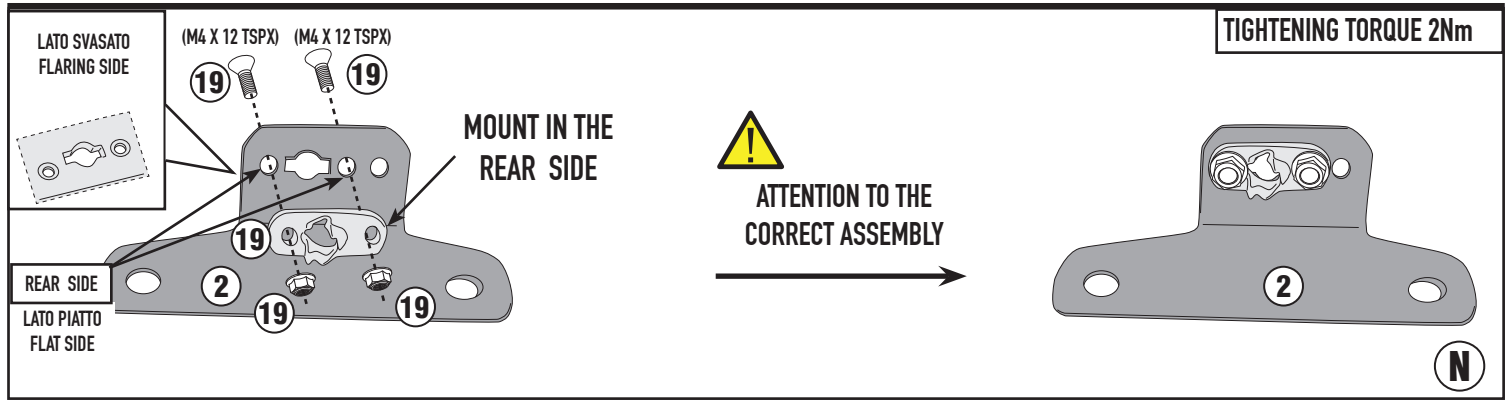

MONTAGGIO/SMONTAGGIO - ASSEMBLY/DISASSEMBLY - MONTAGE/DÉMONTAGE - MONTAGE/DEMONTAGE - MONTAJE/DESMONTAJE - MONTAGEM/DESMONTAGEM

RAPID FITTING

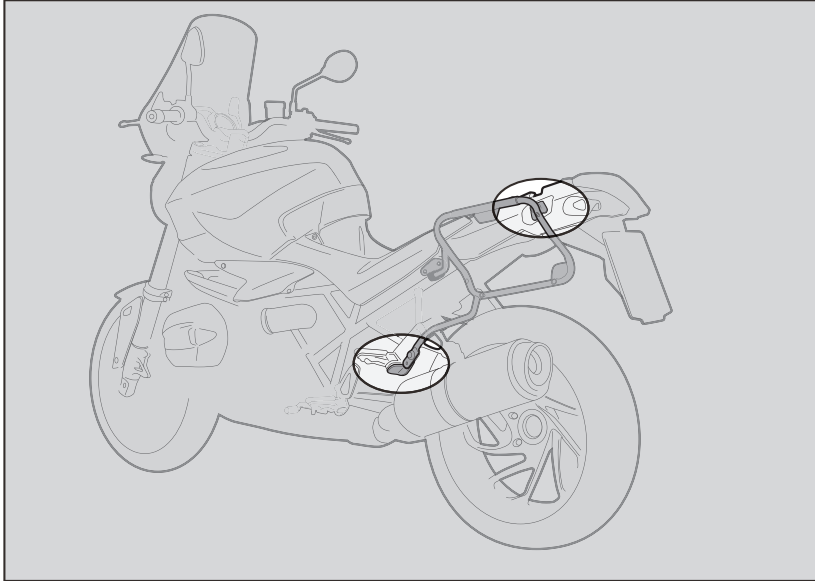

1. INSERIRE L'ATTREZZO NELLA TESTA DELLA VITE SPECIALE;
2. RUOTARE DI 1/4 DI GIRO IN SENSO ORARIO FINO A CHE LA ROTAZIONE NON TERMINA E SI AVVERTE LO SCATTO;
3. PER SMONTARE PROCEDERE IN SENSO INVERSO.

1. INSERT THE SPECIAL KEY INTO THE HEAD OF THE SCREW;
2. TURN THE KEY ¼ TURN CLOCKWISE UNTIL ROTATION STOPS AND THE SIDE CASE HOLDER IS FASTENED SECURELY TO THE FITMENT POINT;
3. IN ORDER TO DISASSEMBLE THE BRACKETRY PERFORM THE OPERATION IN REVERSE.

1. INSERER LA CLE SPECIALE DANS LA TÊTE DE LA VIS;
2. VISSER D'1/4 DE TOUR DANS LE SENS HORAIRE JUSQU'AU BLOCAGE DE LA VIS POUR MONTER EN TOUTE SECURITE LE SUPPORT A SON POINT DE FIXATION;
3. POUR LE DEMONTAGE, PROCEDER EN SENSE INVERSE.

1. STECKEN SIE DAS WERKZEUG IN DEN KOPF DER SPEZIFISCHEN SCHRAUBE;
2. DREHEN SIE DIE SCHRAUBE 1 / 4 UMDREHUNG IM UHRZEIGERSINN BIS SIE BEMERKEN, DASS DIE SCHRAUBE IM BEFESTIGUNGSPUNKT EINGEKLEMMT IST;
3. FÜR DIE DEMONTAGE FOLGEN SIE DEN HINWEISE UMGEKEHRT.

1. INSERTAR LA LLAVE ESPECIAL EN LA CABEZA DEL TORNILLO
2. DAR ¼ DE VUELTA EN EL SENTIDO HORARIO HASTA QUE LLEGUE AL TOPE Y SE VEA EL TORNILLO;
3. PARA DESMONTARLO PROCEDER EN LA DIRECCIÓN CONTRARIA;

MONTAGGIO - ASSEMBLY - MONTAGE - MONTAGE - MONTAJE

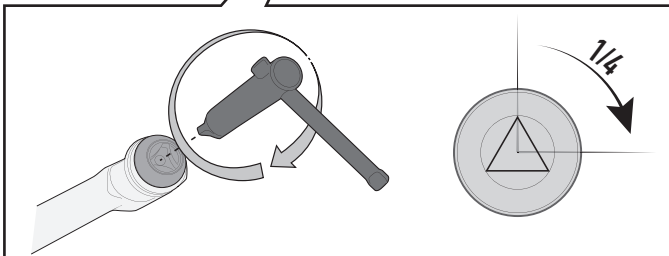
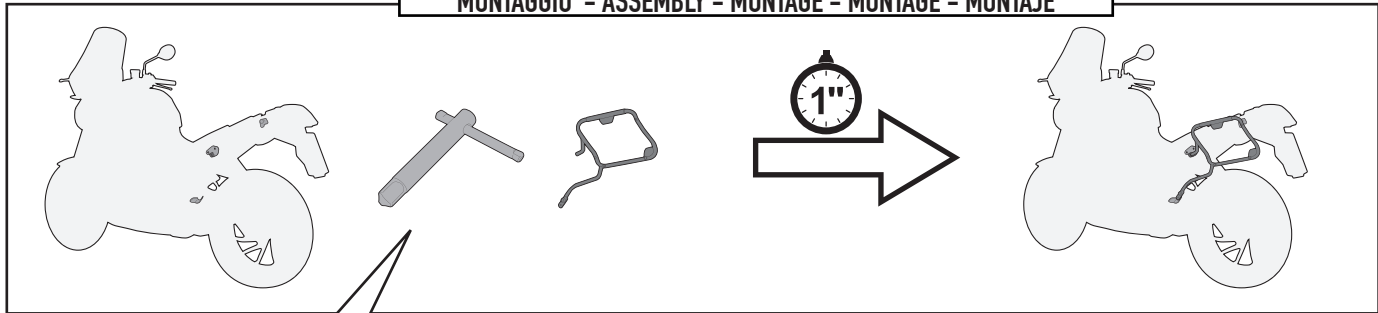

SMONTAGGIO - DISASSEMBLY - DÉMONTAGE - DEMONTAGE - DESMONTAJE

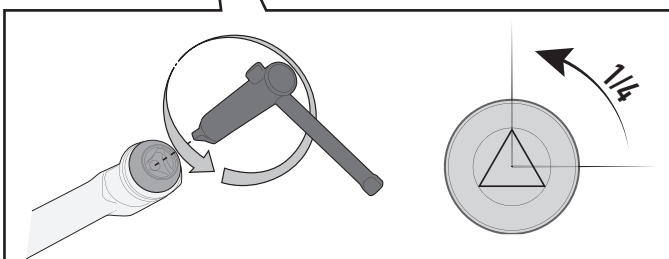
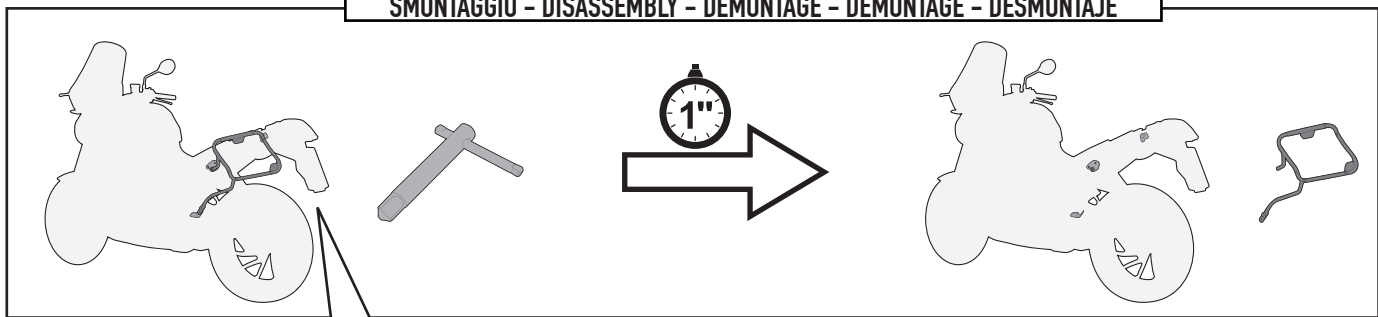

RAPID FITTING

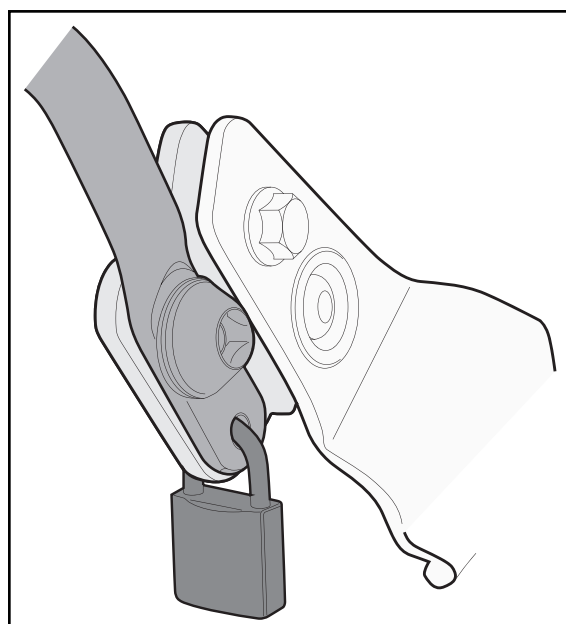
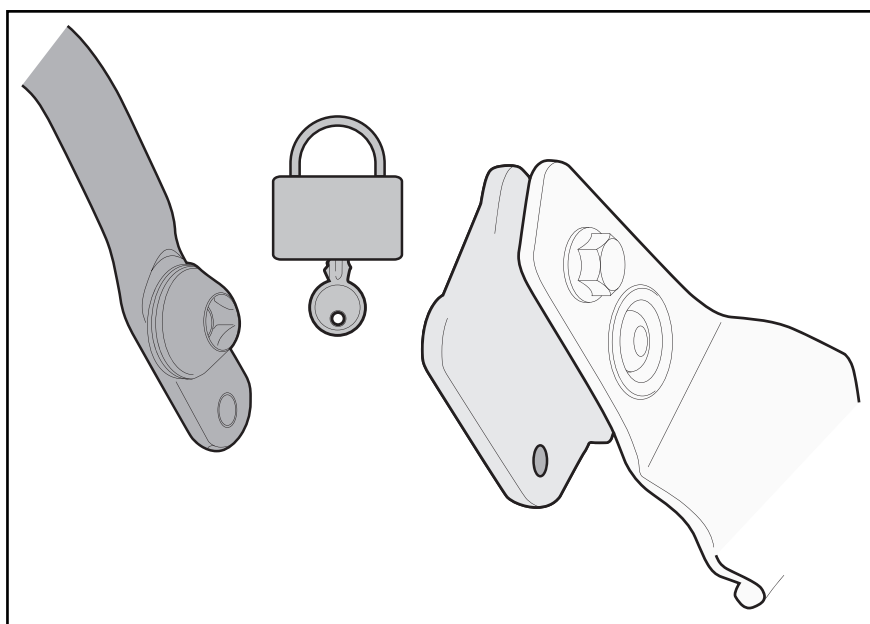
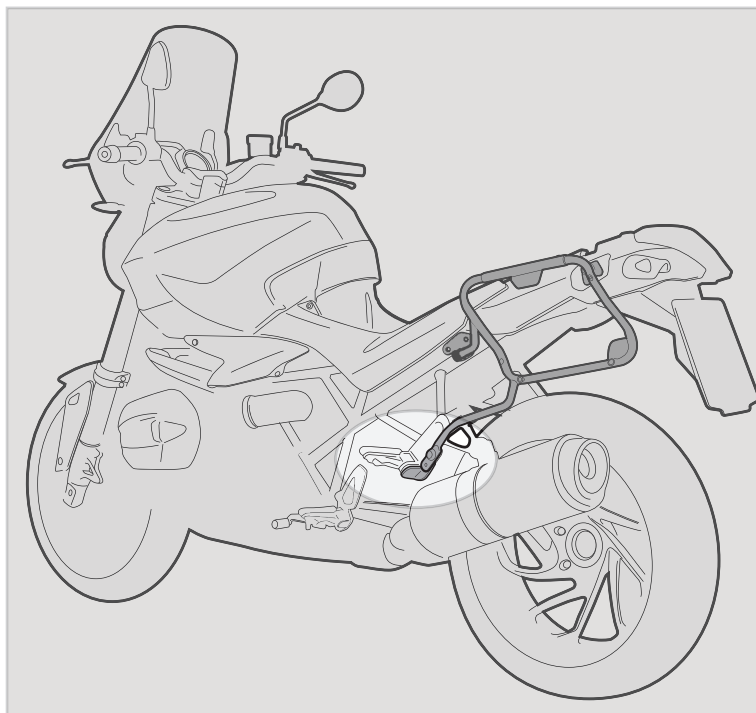

FORO DI SICUREZZA

FORO PREDISPOSTO AD ASSICURARE IL PORTAVALIGIE LATERALE ALLA MOTO (CON UN LUCCHETTO PER ESEMPIO, NON INCLUSO).

SECURITY HOLE

HOLE PLACEMENT IN ORDER TO INCREASE SECURITY OF THE TUBULAR SIDE-CASE HOLDER TO THE MOTORCYCLE (WITH A LOCK, FOR EXAMPLE, NOT INCLUDED).

TROU DE SECURITE

TROU PREDISPOSE POUR ASSURER LE PORTE-VALISE LATERAL A LA MOTO (AVEC UN CADENAS PAR EXEMPLE, NON INCLUS).

SICHERHEITSLÖCH

VORGESEHENES LOCH UM DEN SEITENKOFFER TRÄGER AN DEM FAHRZEUG ZU SICHERN (Z. B. MIT EINEM VORHÄNGESCHLOSS, NICHT ENTHALTEN);

ORIFICIO DE SEGURIDAD

ESTE ORIFICIO ESTA CREADO PARA ASEGURAR EL PORTAEQUIPAJES LATERAL A LA MOTO (POR EJEMPLO CON UN CANDADO, QUE NO ESTÁ INCLUIDO).