

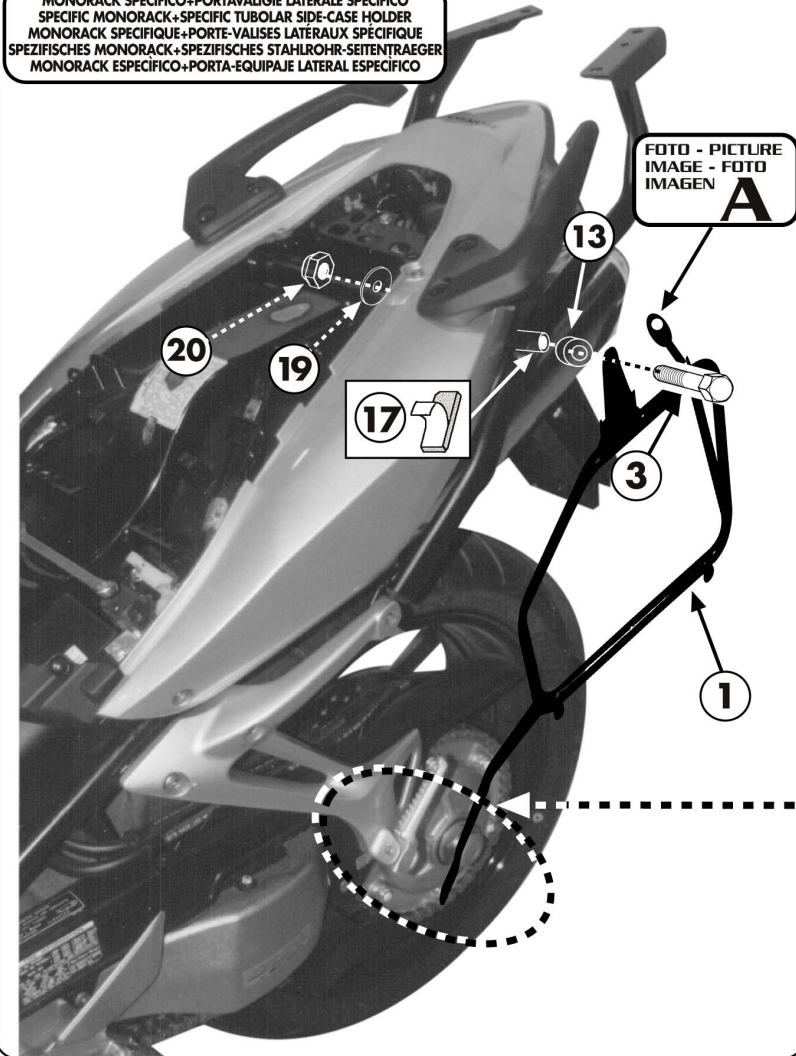







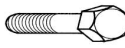

PORTAVALIGIE LATERALE SPECIFICO - SPECIFIC TUBULAR SIDE-CASE HOLDER  
 PORTE-VALISES LATÉRAUX SPÉCIFIQUE - SPEZIFISCHES STAHLROHR-SEITENTRÄGER  
 PORTA-EQUIPAJE LATERAL ESPECIFICO

# HONDA VFR 800 '02/'03 VTEC

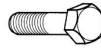
ISTRUZIONI DI MONTAGGIO - MOUNTING INSTRUCTIONS  
 INSTRUCTIONS DE MONTAGE - BAUANLEITUNG - INSTRUCCIONES DE MONTAJE

MONORACK SPECIFICO+PORTAVALIGIE LATERALE SPECIFICO  
 SPECIFIC MONORACK+SPECIFIC TUBULAR SIDE-CASE HOLDER  
 MONORACK SPÉCIFIQUE+PORTE-VALISES LATÉRAUX SPÉCIFIQUE  
 SPEZIFISCHES MONORACK+SPECIFISCHES STAHLROHR-SEITENTRÄGER  
 MONORACK ESPECIFICO+PORTA-EQUIPAJE LATERAL ESPECIFICO



<p>1</p>  <p><b>PIASTRA LASER</b> LASER PLATE PLAQUE LASER LASER PLATTE PLAQUA LASER</p> <p><b>Q.TY n.2(dx-sx)</b></p>	<p>2</p>  <p><b>PIASTRA LASER</b> LASER PLATE PLAQUE LASER LASER PLATTE PLAQUA LASER</p> <p><b>Q.TY n.1</b></p>	<p>3</p>  <p><b>VITE TE M8 x 150</b> SCREW M8 x 150 VIS M8 x 150 SCHRAUBE M8 x 150 TORNILLO M8 x 150</p> <p><b>Q.TY n.2</b></p>	<p>4</p>  <p><b>VITE TE M8 x 16</b> SCREW M8 x 16 VIS M8 x 16 SCHRAUBE M8 x 16 TORNILLO M8 x 16</p> <p><b>Q.TY n.2</b></p>	<p>5</p>  <p><b>VITE TBEI M6 x 55</b> SCREW M6 x 55 VIS M6 x 55 SCHRAUBE M6 x 55 TORNILLO M6 x 55</p> <p><b>Q.TY n.2</b></p>	<p>6</p>  <p><b>VITE TE M6 x 35</b> SCREW M6 x 35 VIS M6 x 35 SCHRAUBE M6 x 35 TORNILLO M6 x 35</p> <p><b>Q.TY n.2</b></p>
<p>7</p>  <p><b>RONDELLA Ø 8</b> WASHER Ø 8 WASHER Ø 8 SCHEIBE Ø 8 ARANDELA Ø 8</p> <p><b>Q.TY n.4</b></p>	<p>8</p>  <p><b>RONDELLA 8 x 14</b> WASHER 8 x 14 WASHER 8 x 14 SCHEIBE 8 x 14 ARANDELA 8 x 14</p> <p><b>Q.TY n.2</b></p>	<p>9</p>  <p><b>RONDELLA Ø 6</b> WASHER Ø 6 WASHER Ø 6 SCHEIBE Ø 6 ARANDELA Ø 6</p> <p><b>Q.TY n.4</b></p>	<p>10</p>  <p><b>RONDELLA 6 x 18</b> WASHER 6 x 18 WASHER 6 x 18 SCHEIBE 6 x 18 ARANDELA 6 x 18</p> <p><b>Q.TY n.2</b></p>	<p>11</p>  <p><b>DADO A.B. M8 rib.</b> BOLT M8 ECROU M8 MUTTER M8 TUERCA M8</p> <p><b>Q.TY n.2</b></p>	<p>12</p>  <p><b>DADO A.B. M6</b> BOLT M6 ECROU M6 MUTTER M6 TUERCA M6</p> <p><b>Q.TY n.2</b></p>

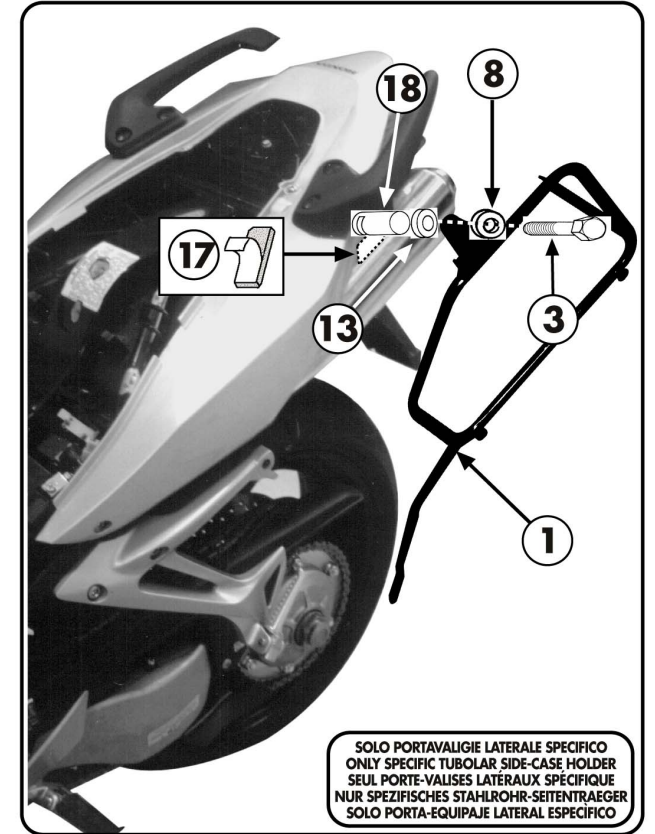
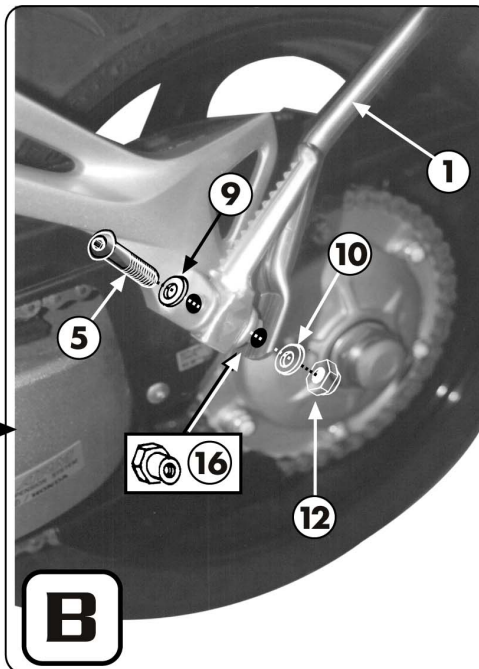

SOLO PORTAVALIGIE LATERALE SPECIFICO  
 ONLY SPECIFIC TUBULAR SIDE-CASE HOLDER  
 SEUL PORTE-VALISES LATÉRAUX SPÉCIFIQUE  
 NUR SPEZIFISCHES STAHLROHR-SEITENTRÄGER  
 SOLO PORTA-EQUIPAJE LATERAL ESPECIFICO

PORTAVALIGIE LATERALE SPECIFICO - SPECIFIC TUBULAR SIDE-CASE HOLDER  
 PORTE-VALISES LATÉRAUX SPECIFIQUE - SPEZIFISCHES STAHLROHR-SEITENTRÄGER  
 PORTA-EQUIPAJE LATERAL ESPECIFICO

# HONDA VFR 800 '02/'03 VTEC

ISTRUZIONI DI MONTAGGIO - MOUNTING INSTRUCTIONS  
 INSTRUCTIONS DE MONTAGE - BAUANLEITUNG - INSTRUCCIONES DE MONTAJE

**13**  
  
**V 014**  
**DISTANZIALE**  
**13X10 Ø 8.5**  
 SPACER 13x10  
 ENTRETOISE 13X10  
 DISTANZSTÜCK 13X10  
 SEPARADOR 13X10  
**Q.TY n.2**

**14**  
  
**V 222**  
**DISTANZIALE**  
**12X4 Ø6.5**  
 SPACER 12X4  
 ENTRETOISE 12X4  
 DISTANZSTÜCK 12X4  
 SEPARADOR 12X4  
**Q.TY n.2**

**15**  
  
**V 463**  
**DISTANZIALE 18x12,5**  
**ribas.9,5x11,5 Ø6.5**  
 SPACER LOW  
 ENTRETOISE BAISSÉ  
 DISTANZSTÜCK  
 SEPARADOR REBAJADO  
**Q.TY n.2**

**16**  
  
**V 258**  
**DADO SPECIALE**  
 SPECIAL BOLT  
 ECROU SPECIALE  
 MUTTER SPEZIAL  
 TUERCA ESPECIAL  
**Q.TY n.2**

**17**  
  
**Z 298**  
**MOUSSE PROTETTIVA**  
 RUBBER PROTECTION  
 MOUSSE DE PROTECTION  
 GUMMI  
 MOUSSE PROTECTORA  
**Q.TY n.2**

**18**  
  
**V 455 dx/sx**  
**DISTANZIALE fresato**  
**95X18 Ø8.5**  
 SPACER 95x18  
 ENTRETOISE 95x18  
 DISTANZSTÜCK 95x18  
 SEPARADOR 95x18  
**Q.TY n.2 dx-sx**

**19**  
  
**RONDELLA 32X2**  
**foro Ø 8,5**  
 WASHER 32X2  
 RONDELLE 32X2  
 SCHEIBE 32X2  
 ARANDELA 32X2  
**Q.TY n.2**

**20**  
  
**DADO A.B. M8**  
 BOLT M8  
 ECROU M8  
 MUTTER M8  
 TUERCA M8  
**Q.TY n.2**

Portatarga lato Sx-Vista dal basso;  
 Number plate holder, left side, as  
 seen from the bottom;  
 Porte plaque d'immatriculation, côté  
 gauche, vue d'en bas;  
 Trägenversteifung nummernschild,  
 von hinten links;  
 Porta matricula lado izquierdo vista  
 desde abajo.

