

MONORACK SPECIFICO - SPECIFIC MONORACK
 MONORACK SPECIFIQUE - SPEZIFISCHES MONORACK - MONORACK ESPECÍFICO

HONDA CB600F 2003 HORNET

ISTRUZIONI DI MONTAGGIO - MOUNTING INSTRUCTIONS
 INSTRUCCIONES DE MONTAJE - BAUANLEITUNG - INSTRUCCIONES DE MONTAJE

1



Q.TY n. 2

2 DX SX

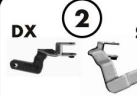

**SUPPORTO
 SUPPORT
 SUPPORT
 HALTER
 SOPORTES**

Q.TY n. 2

3 V011



**DISTANZIALE ANTERIORE
 ø 14X25 FORO 8,5
 FRONT COLLAR DISTANCE
 ø 14X25
 COLLIER DE SEPARATION
 ANTERIEUR ø 14 X 25
 DISTANZSTÜCK ø14X25
 DISTANCIADOR ø 14X25**

Q.TY n. 2

4 V145



**DISTANZIALE POSTERIORE
 ø 14 X 14 FORO 8,5
 REAR COLLAR DISTANCE
 ø 14 X 14
 COLLIER DE SEPARATION
 POSTERIEUR ø 14 X 14
 DISTANZSTÜCK ø14X14
 DISTANCIADOR ø 14X14**

Q.TY n. 2

5



**VITE ANTERIORE
 TBEI M 8 X 70
 FRONT SCREW M 8 X 70
 VIS ANTERIEUR M 8 X 70
 SCHRAUBE M 8X 70
 TORNILLO M 8X 70**

Q.TY n. 2

6

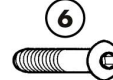

**VITE POSTERIORE
 TBEI M 8 X 100
 REAR SCREW M 8 X 100
 VIS POSTERIEUR M 8X 100
 SCHRAUBE M 8X100
 TORNILLO M 8X100**

Q.TY n. 2

7



**VITE TSCI M 6X35
 SCREW M 6 X 35
 VIS M 6 X 35
 SCHRAUBE M 6 X 35
 TORNILLO M 6 X 35**

Q.TY n. 2

8

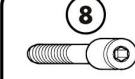

**VITE TCEI M 8 X 20
 SCREW M 8 X 20
 VIS M 8 X 20
 SCHRAUBE M 8X 20
 TORNILLO M 8X 20**

Q.TY n. 2

9



**MOUSSE ADESIVA
 mm 400
 ADHESIVE RUBBER
 CAOUTCHOUC ADHESIF
 MOOSGUMMI
 ESPUMA ADESIVA**

Q.TY n. 1

10



**RONDELLA ø 8X14
 WASHER ø 8 X 14
 RONDELLE ø 8 X 14
 SCHEIBE ø 8 X 14
 ARANDELA ø 8 X 14**

Q.TY n. 4

11

**PARTICOLARI INCLUSI NEL
 KIT VITERIA DELLA PIASTRA
 COMPONENTS INCLUDED IN
 THE FITTING KIT OF THE PLATE
 PIÈCES INCLUES DANS LE KIT
 DE VIS DE LA PLATINE
 DIE EINZELNEN TEILE SIND BEI
 MONTAGEKIT DER PLATTE
 ENTHALTEN
 PIEZAS INCLUIDAS EN EL KIT
 DE ANCLAJE DE LA PLETINA**

Q.TY n.-

© Copyright 23072003-Rev02, 1/2

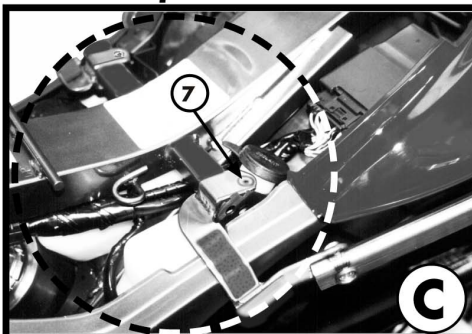
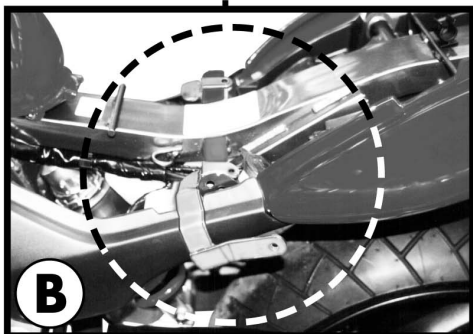
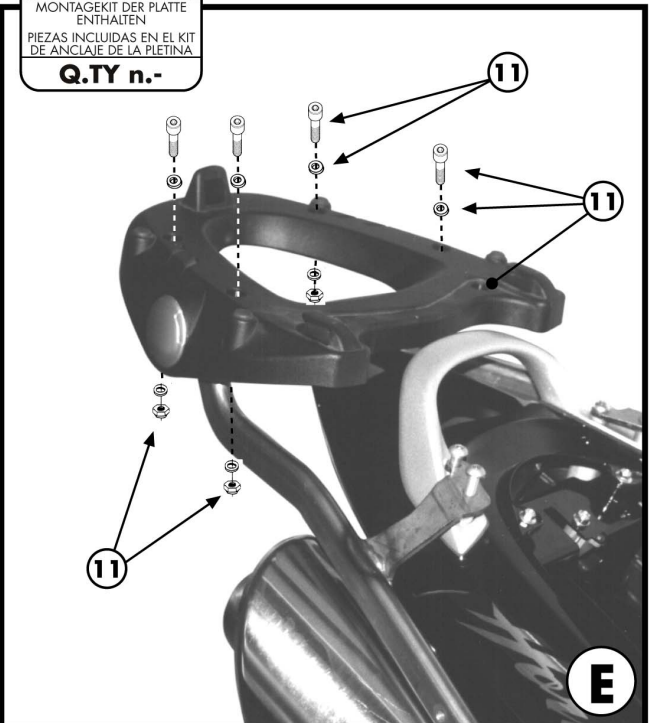
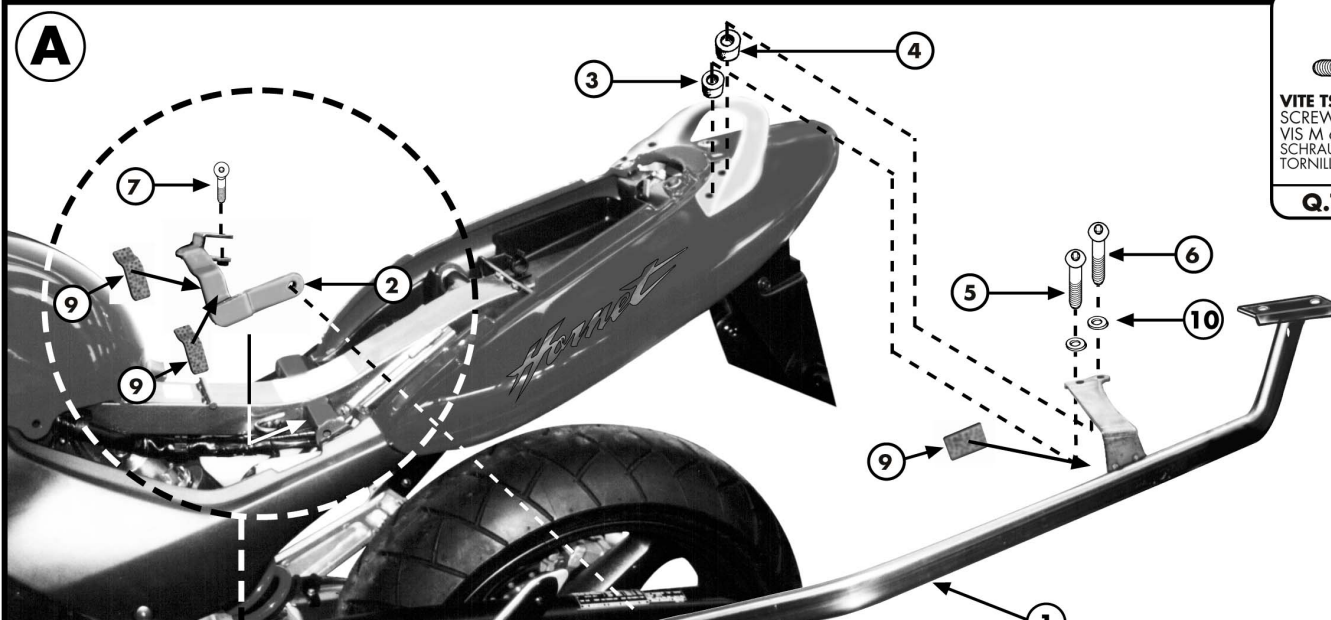

9

**POSIZIONE DELLA MOUSSE ADESIVA
 SUI SUPPORTI
 ADHESIVE RUBBER POSITION ON THE
 SUPPORTS N°2
 POSITION DE LE CAOUTCHOUC
 ADHESIF SUR LE SUPPORTS**

2

**POSITION DER
 AUFZUKLEBEN
 MOOSGUMMISTÜCKE
 AM HALTER
 POSICIÓN DE LA
 ESPUMA ADHESIVA
 SOBRE LOS
 SOPORTES**

D

258FZ-KZ258

MONORACK SPECIFICO - SPECIFIC MONORACK
MONORACK SPECIFIQUE - SPEZIFISCHES MONORACK - MONORACK ESPECÍFICO

HONDA CB600F 2003 HORNET

ISTRUZIONI DI MONTAGGIO - MOUNTING INSTRUCTIONS
INSTRUCTIONS DE MONTAGE - BAUANLEITUNG - INSTRUCCIONES DE MONTAJE

I ISTRUZIONI DI MONTAGGIO

1. FARE ATTENZIONE DI POSIZIONARE LE MOUSSE PROTETTIVE N°9 SUI SUPPORTI N°2 COME INDICATO IN FOTO A E FOTO D.
2. MONTARE I SUPPORTI N°2 COME INDICATO IN FOTO A, FOTO B E FOTO C.
3. FISSARE LE MOUSSE N°9 AI SUPPORTI N°1 COME INDICATO IN FOTO A.
4. MONTARE I SUPPORTI N°1 COME INDICATO IN FOTO A.
5. PROCEDERE AL MONTAGGIO DELLA PIASTRA COME MOSTRATO IN FOTO E.
6. CONCLUDERE IL MONTAGGIO SERRENDO BENE TUTTE LE VITI.

E MOUNTING INSTRUCTIONS

1. PAY ATTENTION TO PLACE THE PROTECTIVE ADHESIVE RUBBERS N°9 ON THE SUPPORTS N° 2 AS SHOWN IN PICTURE A AND D.
2. MOUNT THE SUPPORTS N°2 AS SHOWN IN PICTURE A, B AND C.
3. FIX THE ADHESIVE RUBBERS N°9 TO THE SUPPORT (SIDE ARM) N°1 AS SHOWN IN PICTURE A.
4. NOW MOUNT THE SUPPORT (SIDE ARM) N°1 AS SHOWN IN PICTURE A.
5. PROCEED WITH THE MOUNTING OF THE PLATE AS SHOWN IN PICTURE E.
6. LASTLY TIGHTEN ALL THE SCREWS.

F INSTRUCTIONS DE MONTAGE

1. FAIRE ATTENTION A BIEN POSITIONNER LES MOUSSES DE PROTECTION N°9 SUR LES SUPPORTS N°2 COMME INDIQUE SUR LES PHOTOS A ET D.
2. MONTER LES SUPPORTS N°2 COMME INDIQUE SUR LES PHOTOS A, B ET C.
3. FIXER LA MOUSSE N°9 SUR LES BRAS N°1 COMME INDIQUE SUR LA PHOTO A.
4. MONTER LES BRAS N°1 COMME INDIQUE SUR LA PHOTO A.
5. PROCEDER AU MONTAGE DE LA PLATINE COMME MONTRE SUR LA PHOTO E.
6. FINIR LE MONTAGE EN SERRANT BIEN TOUTES LES VIS.

D BAUANLEITUNG

1. KLEBEN SIE DAS MOOSGUMMISTÜCK NR. 9 AM UNTEREN TEIL DES HALTERS NR. 2. WIE IM BILD A UND D BESCHRIEBEN.
2. MONTIEREN SIE DIE HALTER NR. 2 WIE IM BILD A, B UND C BESCHRIEBEN.
3. JETZT KLEBEN SIE DAS MOOSGUMMISTÜCK NR. 9 AM OBEREN TEIL DES HALTERS NR. 2 WIE IM BILD A UND D BESCHRIEBEN.
4. MONTIEREN SIE DIE HALTER NR. 1 WIE IM BILD E BESCHRIEBEN.
5. MONTIEREN SIE DIE PLATTE WEITER, WIE IM BILD E BESCHRIEBEN.
6. ZULETZT ZIEHEN SIE ALLE SCHRAUBEN FEST.

ES

INSTRUCCIONES DE MONTAJE

1. POSICIONAR LAS ESPUMAS ADHESIVAS NR 9 SOBRE LOS SOPORTES NR 2 COMO INDICAN LAS FOTO A E D
2. MONTAR LOS SOPORTES NR 2 COMO INDICAN LAS FOTOS A, B Y C
3. PEGAR LAS ESPUMAS ADHESIVAS NR 9 A LOS SOPORTES NR 1 COMO INDICA LA FOTO A
4. MONTAR LOS SOPORTES NR 1 COMO INDICA LA FOTO A
5. MONTAR LA PARRILLA COMO INDICA LA FOTO E
6. ACABAR APRETANDO TODOS LOS TORNILLOS