

PL353 - KL353

PORTAVALIGIE LATERALE SPECIFICO - SPECIFIC TUBULAR SIDE-CASE HOLDER
PORTE-VALISES LATÉRAUX SPÉCIFIQUE - SPEZIFISCHES STAHLROHR-SEITENTRÄGER
PORTA MALETAS LATERALES ESPECIFICO

YAMAHA XT660R 2004
YAMAHA XT660X 2004

ISTRUZIONI DI MONTAGGIO - MOUNTING INSTRUCTIONS
INSTRUCTIONS DE MONTAGE - BAUANLEITUNG - INSTRUCCIONES DE MONTAJE

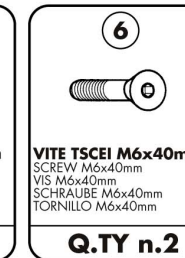
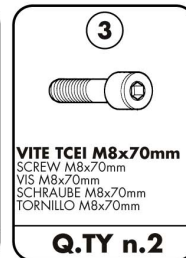
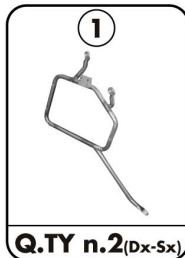

PONTE POSTERIORE
REAR BRIDGE
PONT POSTÉRIEURE
VERBINDUNGSGROHR
PUENTE TRASERO

VITE TCEI M8x70mm
SCREW M8x70mm
VIS M8x70mm
SCHRAUBE M8x70mm
TORNILLO M8x70mm

VITE TCEI M8x50mm
SCREW M8x50mm
VIS M8x50mm
SCHRAUBE M8x50mm
TORNILLO M8x50mm

VITE TBEI M6x50mm
SCREW M6x50mm
VIS M6x50mm
SCHRAUBE M6x50mm
TORNILLO M6x50mm

VITE TSCEI M6x40mm
SCREW M6x40mm
VIS M6x40mm
SCHRAUBE M6x40mm
TORNILLO M6x40mm

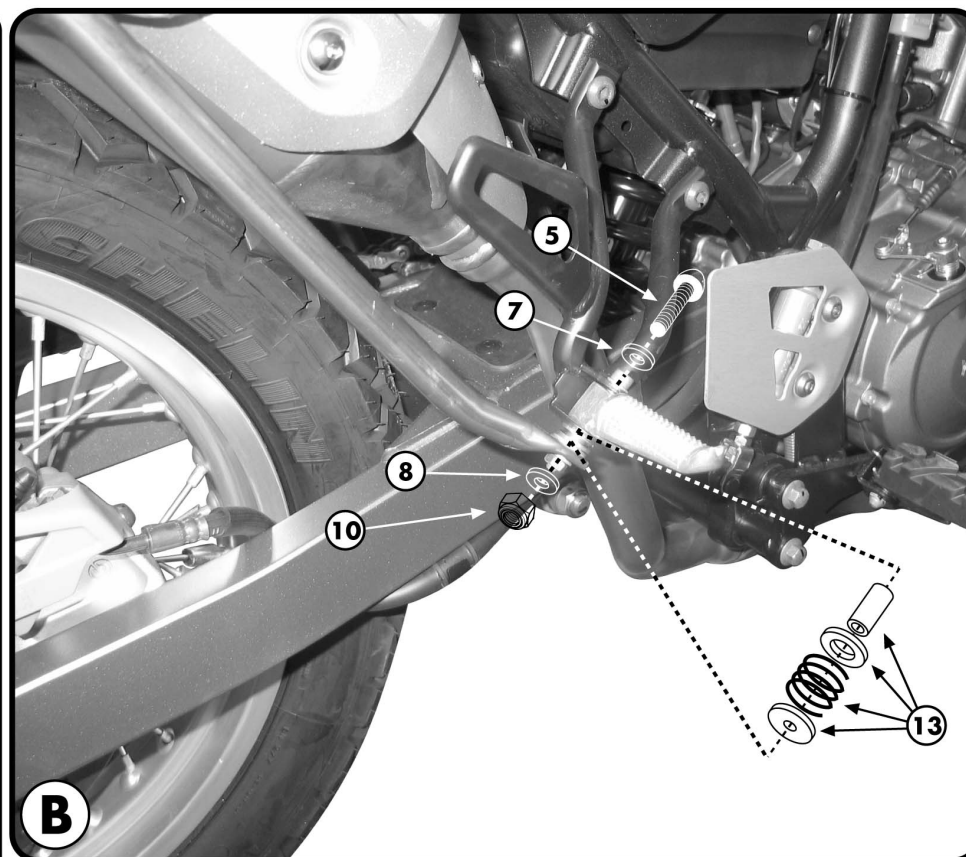
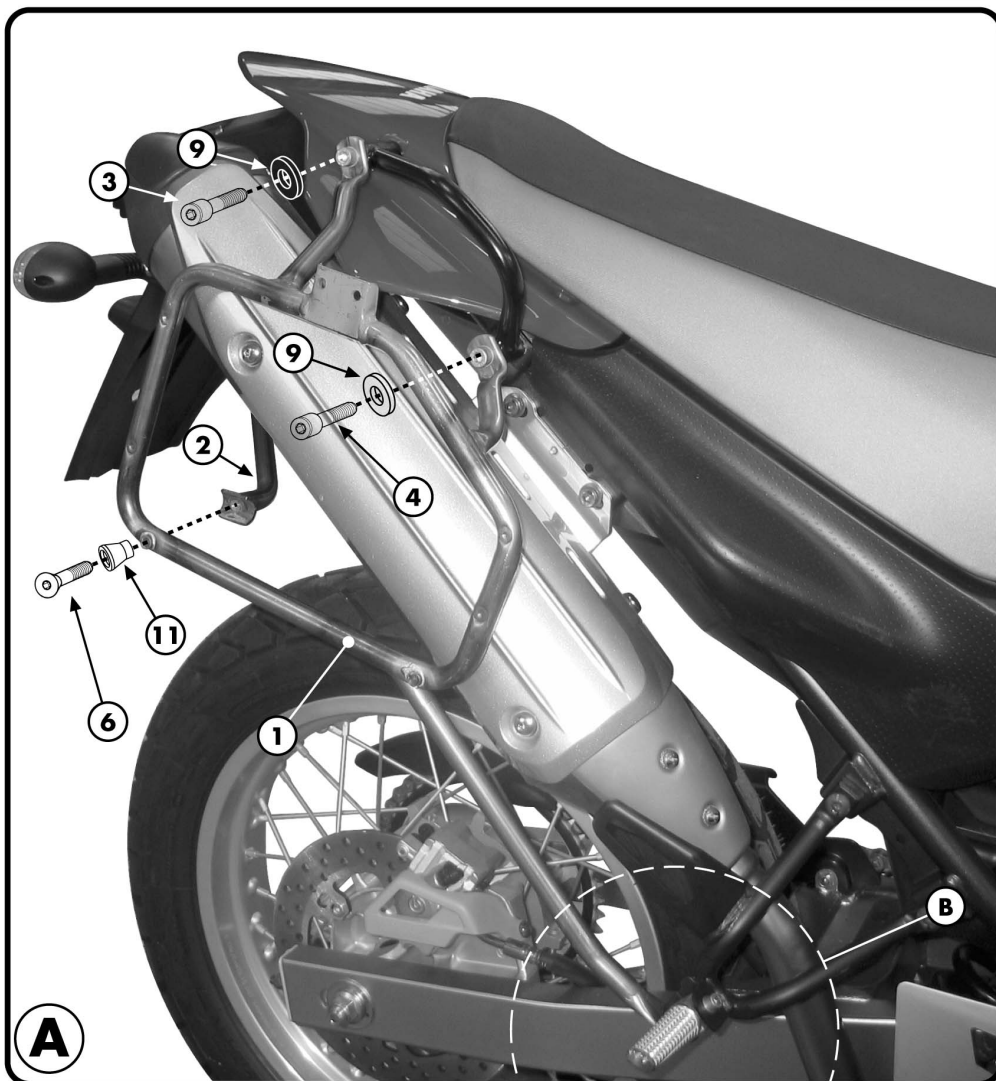

PORTAVALIGIE LATERALE SPECIFICO - SPECIFIC TUBULAR SIDE-CASE HOLDER
 PORTE-VALISES LATÉRAUX SPÉCIFIQUE - SPEZIFISCHES STAHLROHR-SEITENTRAEGER
 PORTA MALETAS LATERALES ESPECIFICO

YAMAHA XT660R 2004
YAMAHA XT660X 2004

ISTRUZIONI DI MONTAGGIO - MOUNTING INSTRUCTIONS
 INSTRUCTIONS DE MONTAGE - BAUANLEITUNG - INSTRUCCIONES DE MONTAJE

7



RONDELLA Ø6mm
 WASHER Ø6mm
 RONDELLE Ø6mm
 SCHEIBE Ø6mm
 ARANDELA Ø6mm

Q.TY n.2

8



RONDELLA Ø6x18mm
 WASHER Ø6x18mm
 RONDELLE Ø6x18mm
 SCHEIBE Ø6x18mm
 ARANDELA Ø6x18mm

Q.TY n.2

9



RONDELLA Ø8x14mm
 WASHER Ø8x14mm
 RONDELLE Ø8x14mm
 SCHEIBE Ø8x14mm
 ARANDELA Ø8x14mm

Q.TY n.4

10



DADO A.B. M6
 BOIT M6
 ECROU M6
 MUTTER M6
 TUERCA M6

Q.TY n.2

11



FUNGHETTO
 SIDE SUPPORT
 CHAMPIGNON
 KOFFER BEFESTIGUNGSTÜCK
 BRIDA

Q.TY n.2

12



V563
DISTANZIALE Ø18x35
foro Ø8,5
 SPACER
 ENTRETOISE
 DISTANZSTUECK
 DISTANCIADOR

Q.TY n.2

13

COMPONENTI ORIGINALI
 ORIGINAL PARTS
 ORIGINAL BAUTEILE
 PARTIES ORIGINALES
 COMPONENTES ORIGINALES

Q.TY n.-

PIASTRA SPECIFICA + PORTAVALIGIE LATERALE SPECIFICO
SPECIFIC PLATE + SPECIFIC TUBULAR SIDE-CASE HOLDER
PLATINE SPECIFIQUE +PORTE-VALISES LATÉRAUX SPÉCIFIQUE
SPEZIFISCHE PLATTE +SPEZIFISCHES STAHLROHR-SEITENTRAEGER
PLETINA ESPECIFICA +PORTA-EQUIPAJE LATERAL ESPECIFICO

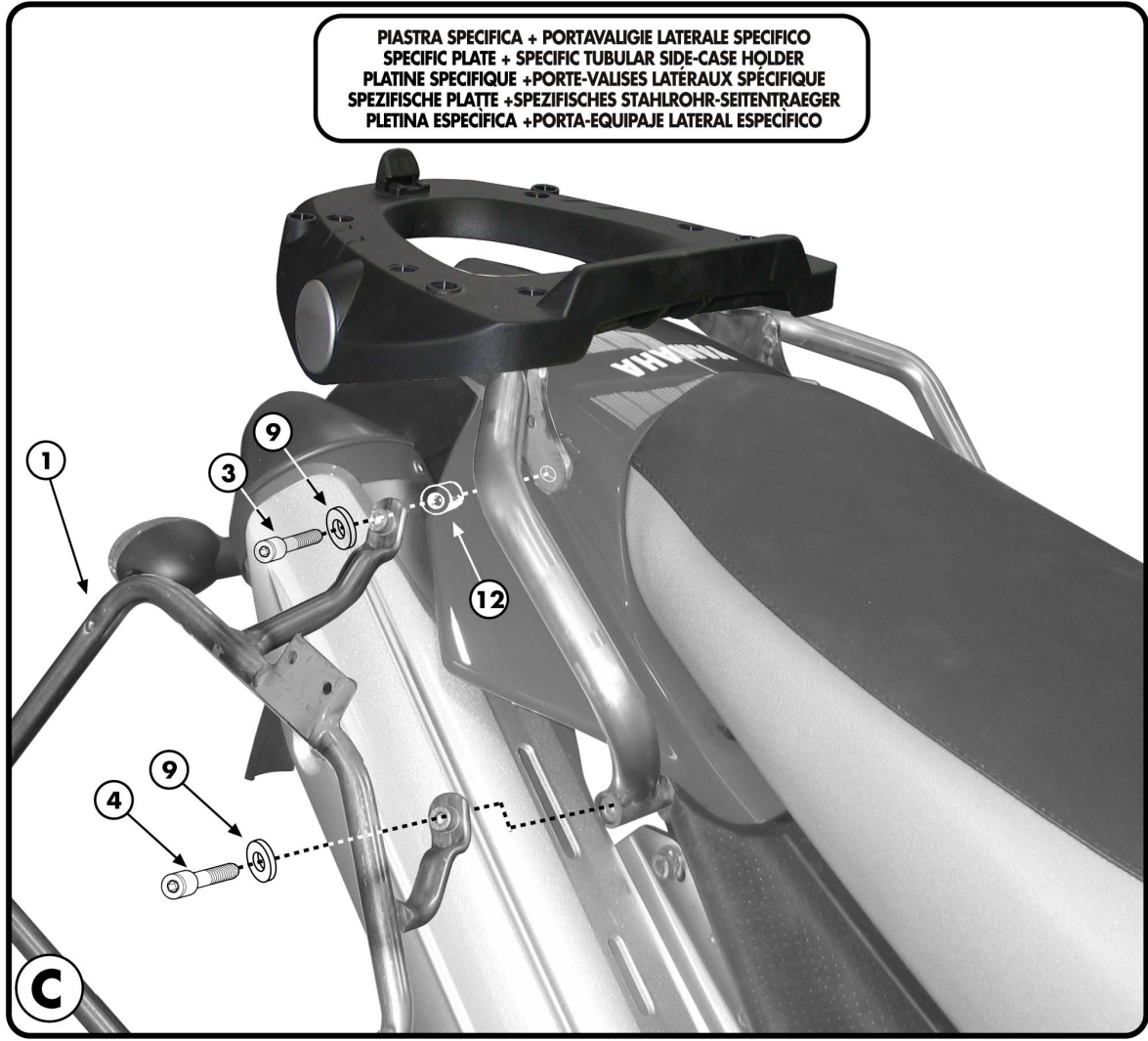

PORTAVALIGIE LATERALE SPECIFICO - SPECIFIC TUBULAR SIDE-CASE HOLDER
 PORTE-VALISES LATÉRAUX SPÉCIFIQUE - SPEZIFISCHES STAHLROHR-SEITENTRÄGER
 PORTA MALETAS LATERALES ESPECÍFICO

YAMAHA XT660R 2004
YAMAHA XT660X 2004

ISTRUZIONI DI MONTAGGIO - MOUNTING INSTRUCTIONS
 INSTRUCTIONS DE MONTAGE - BAUANLEITUNG - INSTRUCCIONES DE MONTAJE

I ISTRUZIONI DI MONTAGGIO

MONTAGGIO PORTAVALIGIE LATERALE SPECIFICO SENZA PORTAVALIGIA CENTRALE SPECIFICO (FOTO A e B):

1. POSIZIONARE IL SUPPORTO N°1 COME INDICATO IN FOTO A;
2. FISSARE IL PARTICOLARE N°2 COME MOSTRATO IN FOTO A;
3. FISSARE IL SUPPORTO N°1 ALLA PEDALINA PASSEGGERO COME INDICATO IN FOTO B.
4. ULTIMARE IL MONTAGGIO CONTROLLANDO CHE TUTTE LE VITI SIANO SERRATE BENE.

MONTAGGIO PORTAVALIGIE LATERALE SPECIFICO CON PORTAVALIGIA CENTRALE SPECIFICO MONTATO (FOTO B e C):

1. POSIZIONARE IL SUPPORTO N°1 COME INDICATO IN FOTO C;
2. FISSARE IL PARTICOLARE N°2 COME MOSTRATO IN FOTO A;
3. FISSARE IL SUPPORTO N°1 ALLA PEDALINA PASSEGGERO COME INDICATO IN FOTO B.
4. ULTIMARE IL MONTAGGIO CONTROLLANDO CHE TUTTE LE VITI SIANO SERRATE BENE.

GB MOUNTING INSTRUCTIONS

MOUNTING OF THE SPECIFIC SIDE-CASE HOLDER WITHOUT THE SPECIFIC CASE CARRIER (PICTURE A AND B)

1. PLACE THE SIDE HOLDER N° 1 AS SHOWN IN PICTURE A;
2. FIX THE PART N° 2 AS SHOWN IN PICTURE A;
3. NOW FIX THE SIDE HOLDER N° 1 TO THE PASSENGER'S FOOTREST AS SHOWN IN PICTURE B;
4. LASTLY TIGHTEN ALL THE SCREWS.

MOUNTING OF THE SPECIFIC SIDE-CASE HOLDER WITH THE SPECIFIC CASE CARRIER ALREADY MOUNTED (PICTURE B AND C)

1. PLACE THE SIDE HOLDER N° 1 AS SHOWN IN PICTURE C;
2. FIX THE PART N° 2 AS SHOWN IN PICTURE A;
3. NOW FIX THE SIDE HOLDER N° 1 TO THE PASSENGER'S FOOTREST AS SHOWN IN PICTURE B;
4. LASTLY TIGHTEN ALL THE SCREWS.

F INSTRUCTIONS DE MONTAGE

MONTAGE SUPPORTS VALISES SANS SUPPORT TOP CASE (PHOTOS A + B)

1. POSITIONNER LES SUPPORTS N°1 COMME INDIQUE SUR LA PHOTO A;
2. FIXER LA PIECE N°2 COMME MONTRE SUR LA PHOTO A;
3. FIXER LES SUPPORTS N°1 AUX REPOSE-PIEDS PASSAGER COMME INDIQUE SUR LA PHOTO B;
4. TERMINER LE MONTAGE EN CONTROLANT LE BON SERRAGE DE TOUTES LES VIS.

MONTAGE SUPPORTS VALISES AVEC SUPPORT TOP CASE SPECIFIQUE (PHOTOS B + C)

1. POSITIONNER LES SUPPORTS N°1 COMME INDIQUE SUR LA PHOTO C;
2. FIXER LA PIECE N°2 COMME MONTRE SUR LA PHOTO A;
3. FIXER LES SUPPORTS N°1 AUX REPOSE-PIEDS PASSAGER COMME INDIQUE SUR LA PHOTO B;
4. TERMINER LE MONTAGE EN CONTROLANT LE BON SERRAGE DE TOUTES LES VIS.

D BAUANLEITUNG

MONTAGE DES SPEZIFISCHEN SEITENKOFFERTRÄGERS OHNE DEN SPEZIFISCHEN TOPCASETRÄGER (BILD A UND B)

1. POSITIONIEREN SIE DAS SEITENTEIL NR. 1 WIE IM BILD A BESCHRIEBEN;
2. BEFESTIGEN SIE DAS VERBINDUNGSROHR NR. 2 WIE IM BILD A BESCHRIEBEN;
3. BEFESTIGEN SIE DAS SEITENTEIL NR. 1 AN DEN BEIFAHRE-FUßRASTEN WIE IM BILD B BESCHRIEBEN;
4. ZULETZT ZIEHEN SIE ALLE SCHRAUBEN FEST.

MONTAGE DES SPEZIFISCHEN SEITENKOFFERTRÄGERS MIT DEM MONTIERTEN SPEZIFISCHEN TOPCASETRÄGER (BILD B UND C)

1. POSITIONIEREN SIE DAS SEITENTEIL NR. 1 WIE IM BILD C BESCHRIEBEN;
2. BEFESTIGEN SIE DAS VERBINDUNGSROHR NR. 2 WIE IM BILD A BESCHRIEBEN;
3. BEFESTIGEN SIE DAS TEIL NR. 1 AN DEN FUßRASTEN WIE IM BILD B BESCHRIEBEN;
4. ZULETZT ZIEHEN SIE ALLE SCHRAUBEN FEST.

ES

INSTRUCCIONES DE MONTAJE

MONTAJE DEL PORTA MALETAS LATERAL ESPECÍFICO SIN EL PORTA MALETAS TRASERO (FOTOS A Y B)

1. MONTAR EL PORTA MALETAS LATERAL N° 1 COMO INDICA LA FOTO A;
2. ANCLAR EL DETALLE N° 2 COMO INDICA LA FOTO A;
3. ANCLAR EL PORTA MALETAS A LA ESTRIBERA DEL PASAJERO COMO INDICA LA FOTO B;
4. TERMINAR EL MONTAJE APRETANDO TODOS LOS TORNILLOS

MONTAJE DEL PORTA MALETAS LATERAL ESPECÍFICO COMBINADO CON EL PORTA MALETAS TRASERO (FOTOS B Y C)

5. MONTAR EL PORTA MALETAS LATERAL N° 1 COMO INDICA LA FOTO C;
6. ANCLAR EL DETALLE N° 2 COMO INDICA LA FOTO A;
7. ANCLAR EL PORTA MALETAS A LA ESTRIBERA DEL PASAJERO COMO INDICA LA FOTO B;
8. TERMINAR EL MONTAJE APRETANDO TODOS LOS TORNILLOS