

E581 - K581

PIASTRA SPECIFICA - SPECIFIC PLATE
 PLATINE SPECIFIQUE - SPECIFISCHE PLATTE - PARRILLA ESPECIFICA
KAWASAKI KLR 650cc 2008

ISTRUZIONI DI MONTAGGIO - MOUNTING INSTRUCTIONS
 INSTRUCTIONS DE MONTAGE - BAUANLEITUNG - INSTRUCCIONES DE MONTAJE

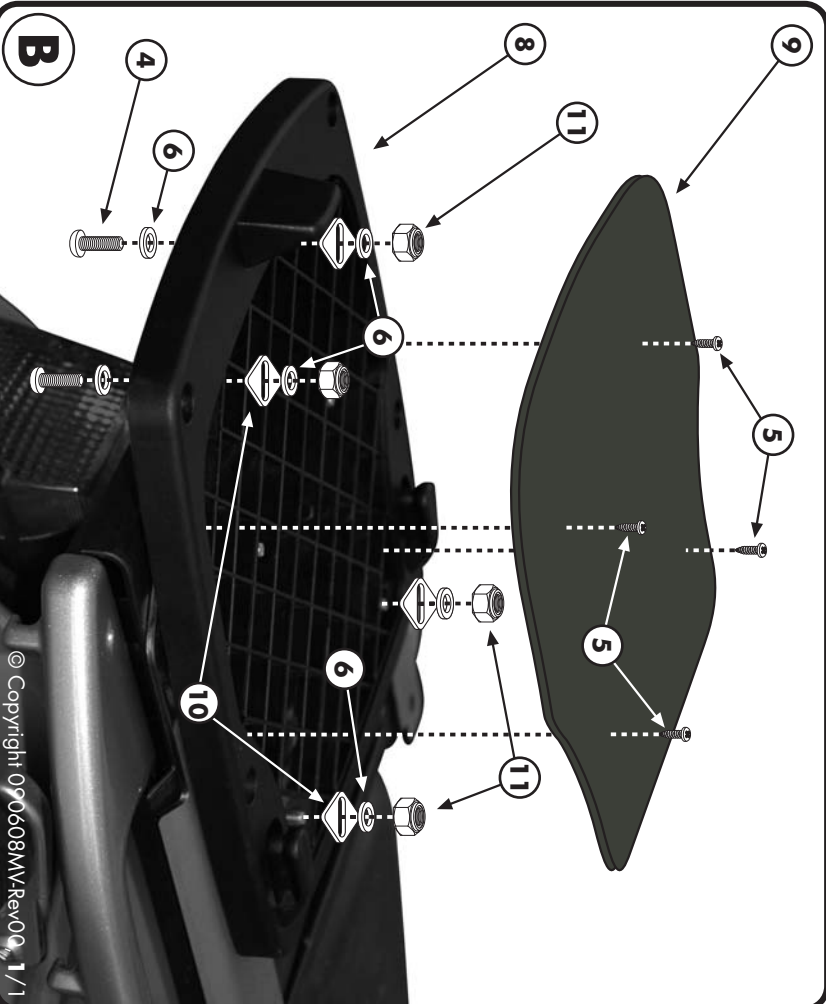
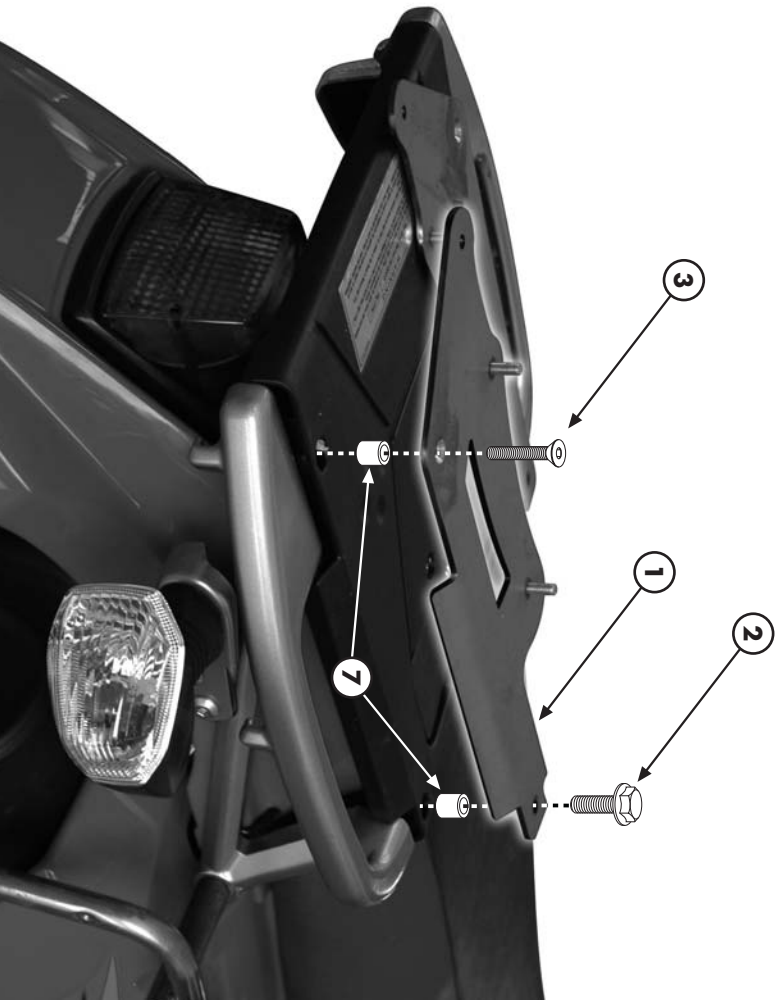
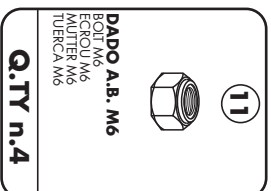
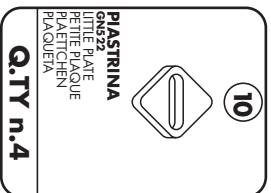
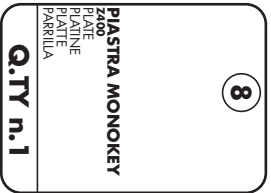
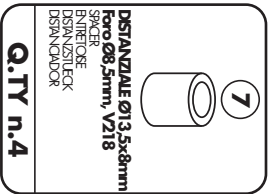
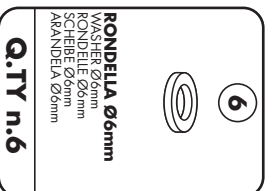
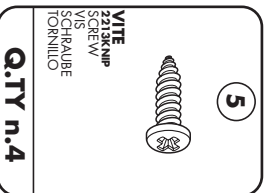
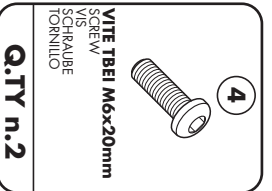
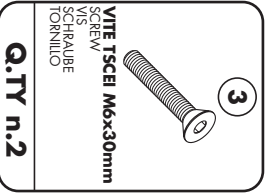
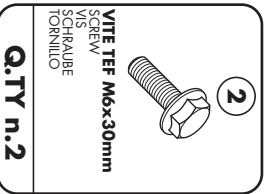
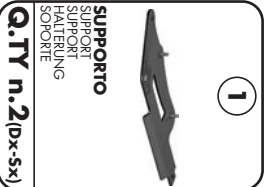

A

ATTENZIONE: PESO MASSIMO SOPPORTABILE 10Kg.
WARNING: MAX. LOADING OF THE CARRIER 10Kg. (21lbs)
ATTENTION: CHARGE MAXIMALE 10Kg.
ACHTUNG: MAXIMALE BELASTUNG 10Kg.
¡ATENCIÓN! CARGA MÁXIMA AUTORIZADA 10Kg.