

3

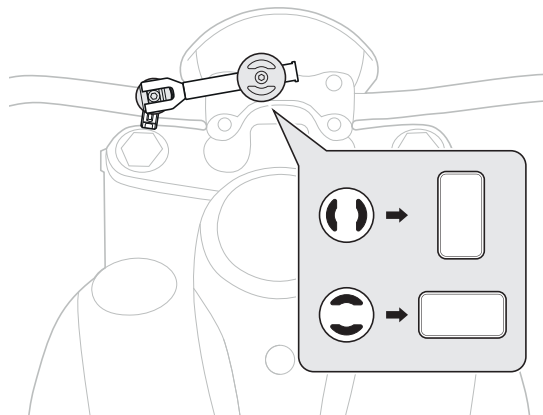

4

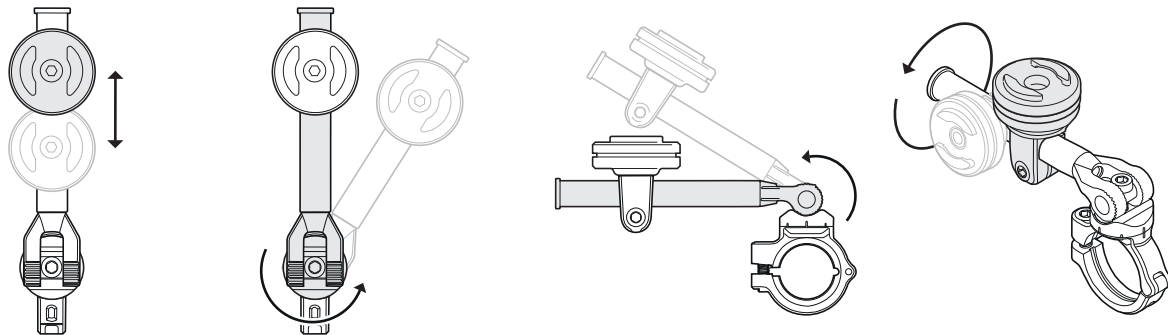





SPTM
CONNECT

MOTO MOUNT
3D



1

- a0  \varnothing 1.25" / 31,8 mm
- a1  \varnothing 1.125" / 28,5 mm
- a2  \varnothing 1.063" / 27,0 mm
- a3  \varnothing 1" / 25,4mm
- a4  \varnothing 0.875" / 22,2mm

Spacing adapter
Distanzadapter
Adaptateur d'espacement
Adaptador espaciador

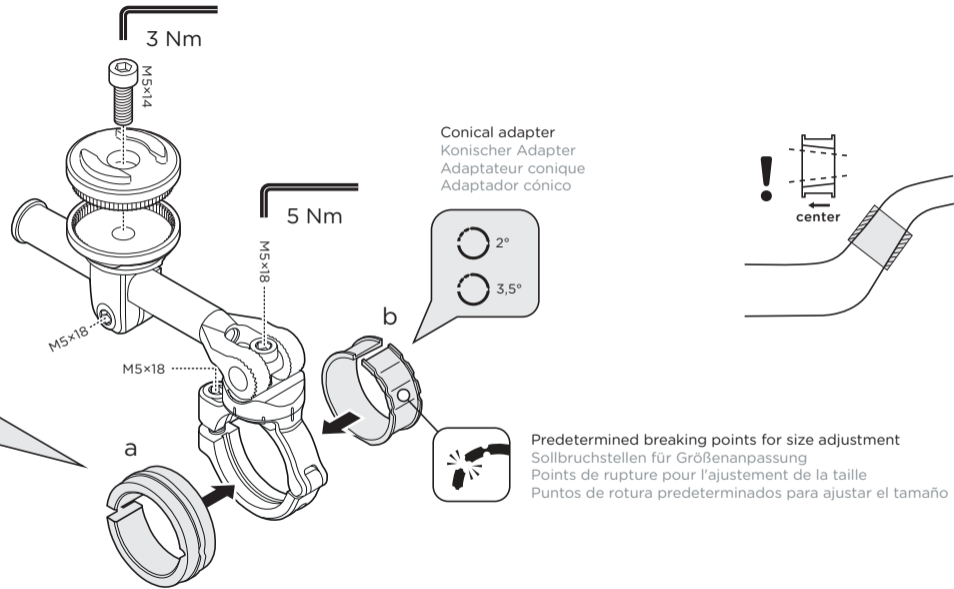

Predetermined breaking points for size adjustment
Sollbruchstellen für Größenanpassung
Points de rupture pour l'ajustement de la taille
Puntos de rotura predeterminados para ajustar el tamaño

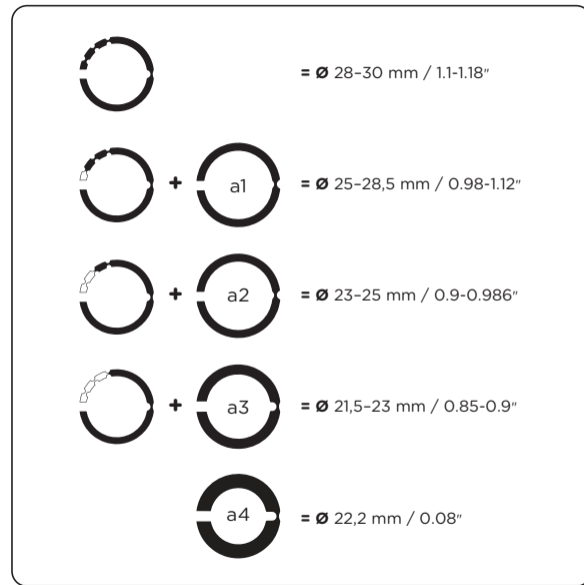

2

