

SENA

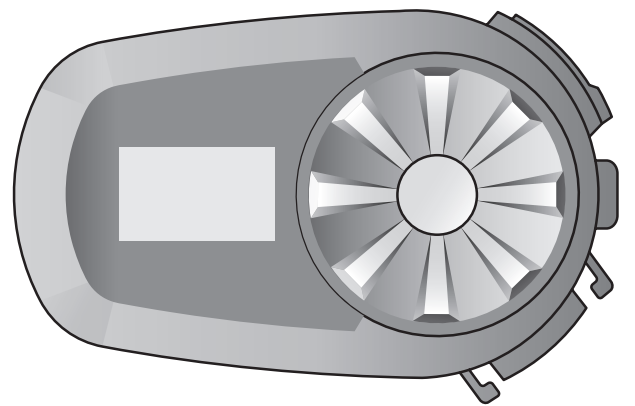

SS

**MOTORCYCLE BLUETOOTH[®]
COMMUNICATION SYSTEM**

HD SPEAKERS

USER'S GUIDE

TABLE OF CONTENTS

1.	ABOUT THE MOTORCYCLE BLUETOOTH COMMUNICATION SYSTEM	5
<hr/>		
1.1	Product Details	5
1.1.1	Headset Main Unit	5
1.1.2	LCD Display	5
1.2	Package Contents	6
2.	INSTALLING THE HEADSET ON YOUR HELMET	7
<hr/>		
2.1	Helmet Installation	7
2.1.1	Using the Clamp Unit	7
2.1.2	Using the Glued Surface Mounting Plate	8
2.2	Installing the Speakers	8
2.3	Installing the Microphone	9
2.3.1	Installing the Attachable Boom Microphone	9
2.3.2	Installing the Wired Microphone	11
3.	GETTING STARTED	13
<hr/>		
3.1	Buttons	13
3.2	Downloadable Sena Software	13
3.2.1	SENA MOTORCYCLES App	13
3.2.2	Sena Device Manager	13
3.3	Legend	14
3.4	Powering On and Off	14
3.5	Charging	15
3.6	Checking the Battery Level	15
3.7	Volume Adjustment	16
4.	PAIRING THE HEADSET WITH OTHER BLUETOOTH DEVICES	17
<hr/>		
4.1	Phone Pairing	17
4.1.1	Initially Pairing the 5S	17
4.1.2	Pairing When the 5S is Turned Off	18
4.1.3	Pairing When the 5S is Turned On	19

4.2	Second Mobile Phone Pairing - Second Mobile Phone, GPS, and SR10	20
4.3	Advanced Selective Pairing: Hands-Free or A2DP Stereo	21
4.3.1	Phone Selective Pairing - Hands-Free Profile	21
4.3.2	Media Selective Pairing - A2DP Profile	22
4.4	GPS Pairing	23
5.	MOBILE PHONE USAGE	24
5.1	Making and Answering Calls	24
5.2	Speed Dialing	24
5.2.1	Assigning Speed Dial Presets	24
5.2.2	Using Speed Dial Presets	25
6.	STEREO MUSIC	27
6.1	Playing Music with Bluetooth Devices	27
6.2	Music Sharing	28
7.	BLUETOOTH INTERCOM	29
7.1	Intercom Pairing	29
7.1.1	Using the Smart Intercom Pairing (SIP)	29
7.1.2	Using the Button	30
7.2	Two-Way Intercom	31
7.3	Universal Intercom	32
8.	FUNCTION PRIORITY AND FIRMWARE UPGRADES	33
8.1	Function Priority	33
8.2	Firmware Upgrades	33

9.	CONFIGURATION SETTING	34
9.1	Headset Configuration Setting	34
9.1.1	Delete All Pairings	34
9.1.2	Remote Control Pairing	35
9.2	Software Configuration Setting	35
9.2.1	Speed Dial	35
9.2.2	Headset Language	35
9.2.3	Audio Equalizer (Default: Off)	36
9.2.4	VOX Phone (Default: Enable)	36
9.2.5	VOX Intercom (Default: Disable)	36
9.2.6	Audio Source Priority (Default: Intercom)	36
9.2.7	Audio Multitasking™ (Default: Disable)	37
9.2.8	Background Volume (Default: Level 5)	38
9.2.9	HD Intercom (Default: Enable)	38
9.2.10	HD Voice (Default: Enable)	38
9.2.11	Voice Prompt (Default: Enable)	38
9.2.12	Advanced Noise Control™ (Always On)	38
10.	TROUBLESHOOTING	39
10.1	Fault Reset	39
10.2	Factory Reset	40

1. ABOUT THE MOTORCYCLE BLUETOOTH COMMUNICATION SYSTEM

1.1 Product Details

1.1.1 Headset Main Unit

DC Power Charging & Firmware Upgrade Port

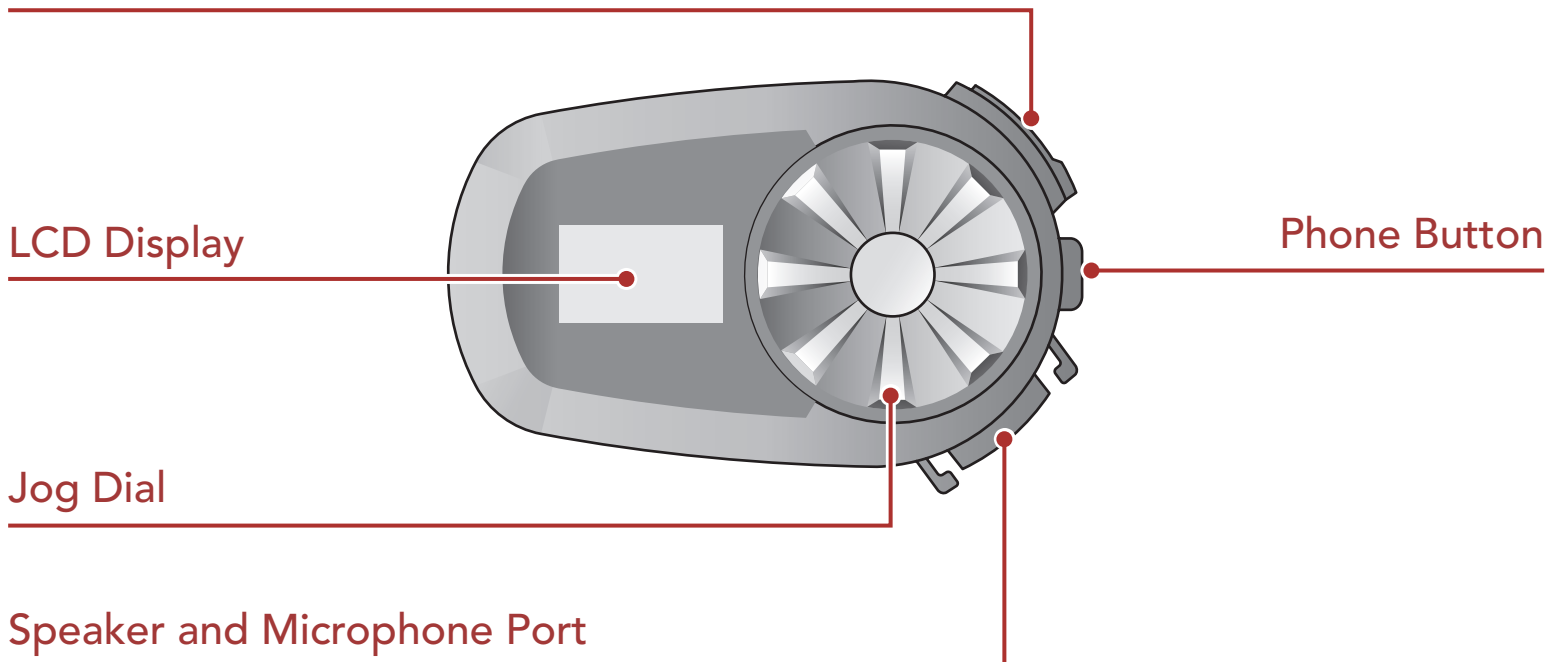

1.1.2 LCD Display

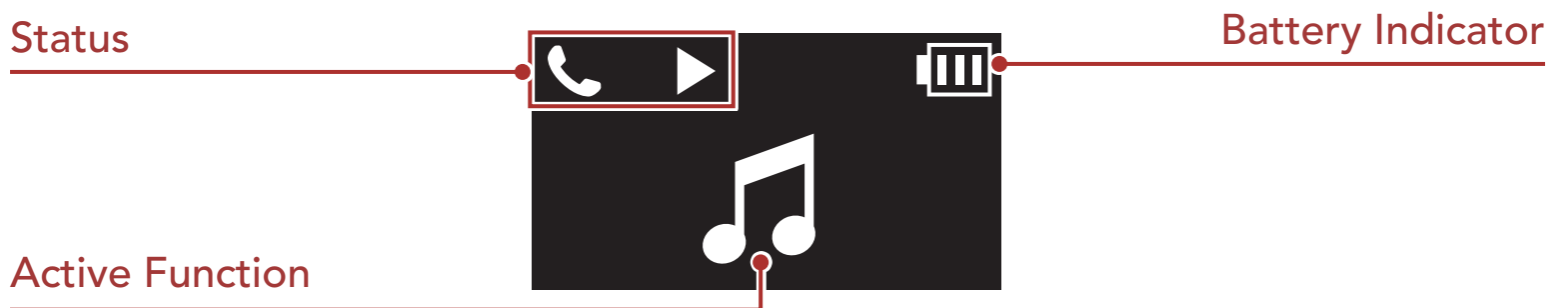

1.2 Package Contents

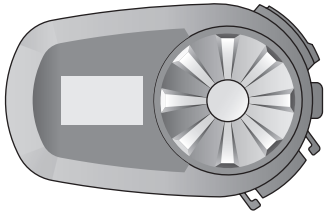

Headset Main Unit

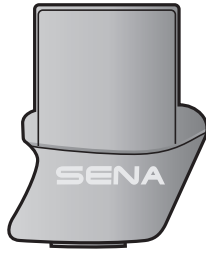

Clamp Unit

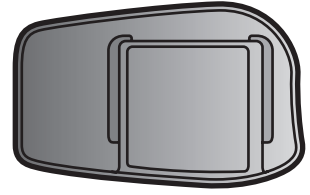

Glued Surface Mounting Plate

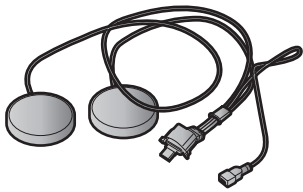

Speakers

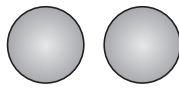

Speaker Pads

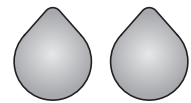

Hook and Loop Fasteners for Speakers



Wired Boom Microphone

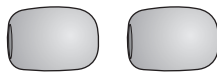

Microphone Sponges

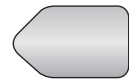

Hook and Loop Fastener for Boom Microphone

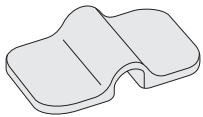

Boom Microphone Holder

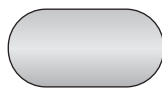

Hook and Loop Fastener for Holder



Wired Microphone

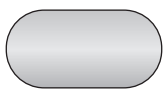

Hook and Loop Fastener for Wired Microphone

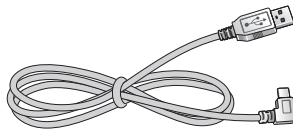

USB Power & Data Cable (USB-C)



Allen Wrench

2. INSTALLING THE HEADSET ON YOUR HELMET

2.1 Helmet Installation

2.1.1 Using the Clamp Unit

1. Loosen the two screws on the back plate of the clamp unit with the included Allen wrench.

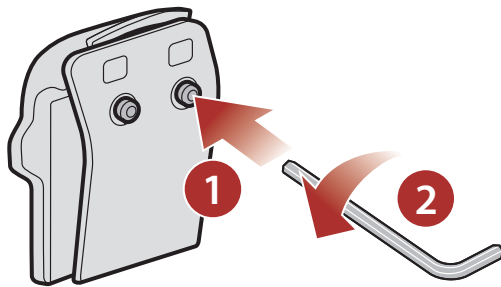

2. Insert the back plate of the clamp unit between the internal padding and external shell of the left side of the helmet.

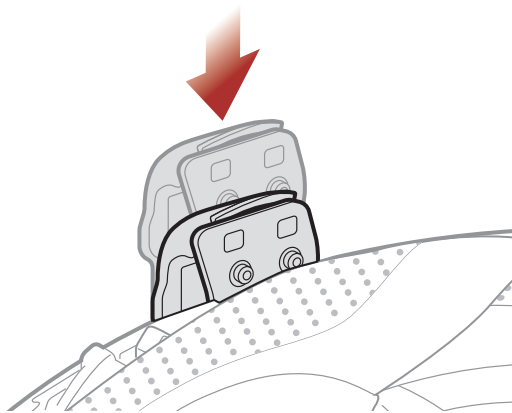

3. Tighten the two screws until the clamp unit is fastened firmly to the helmet.

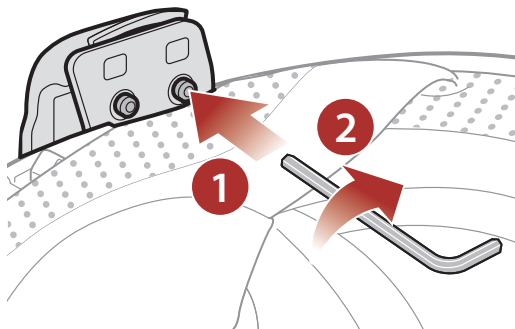

4. Attach the main unit to the clamp unit until you hear a click.

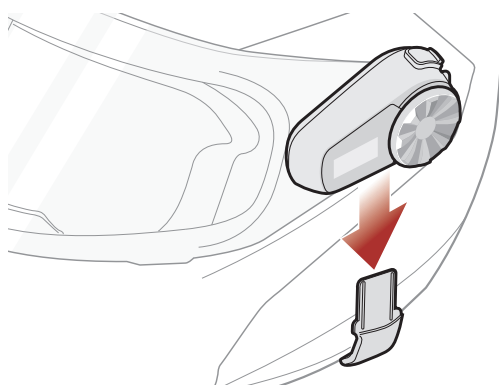

2.1.2 Using the Glued Surface Mounting Plate

If you cannot install the clamp unit on the helmet, you can use the glued surface mounting plate to attach the clamp unit to the surface of the helmet.

1. Attach adhesive tape of the glued surface mounting plate to the helmet.



2. Make sure that the glued surface mounting plate sticks on the helmet firmly. Maximum adhesion occurs after 24 hours.
3. Attach the main unit to the glued surface mounting plate until you hear a click.

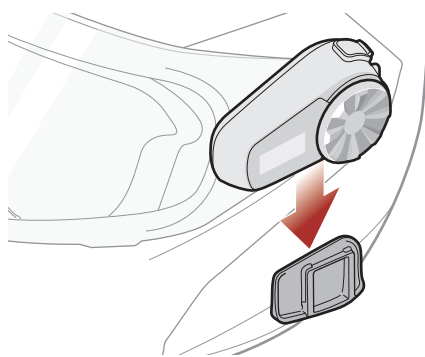

2.2 Installing the Speakers

1. Attach the hook and loop fasteners for speakers to ear pockets inside the helmet.

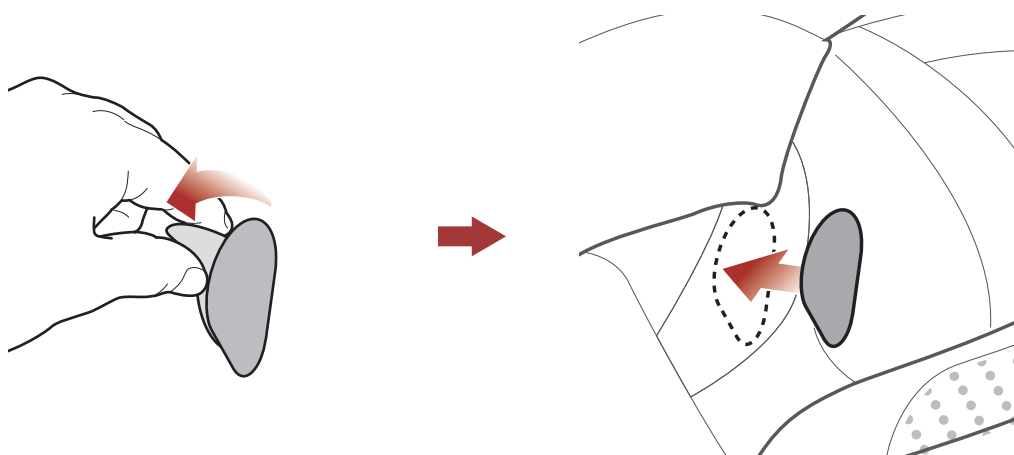

2. Attach the speakers to the hook and loop fasteners for speakers inside the helmet.

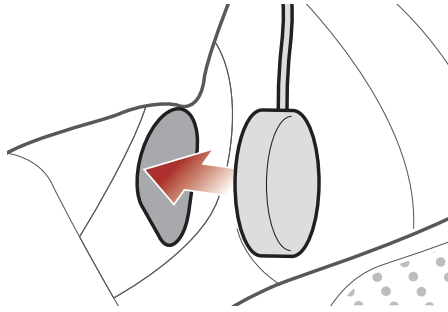

Note: If the helmet has deep ear pockets, you can use the speaker pads to bring the speakers closer to your ears.

2.3 Installing the Microphone

2.3.1 Installing the Attachable Boom Microphone

1. Attach the hook and loop fastener for attachable boom microphone on the inside surface of the left external shell.

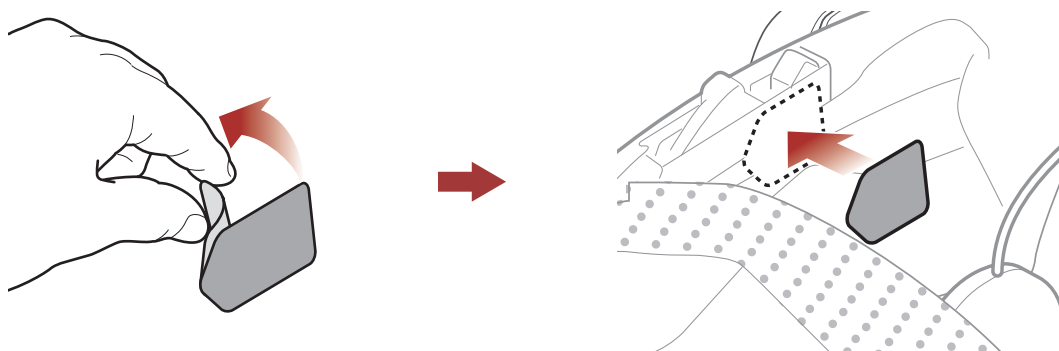

2. Attach the attachable boom microphone's mounting plate to the hook and loop fastener.

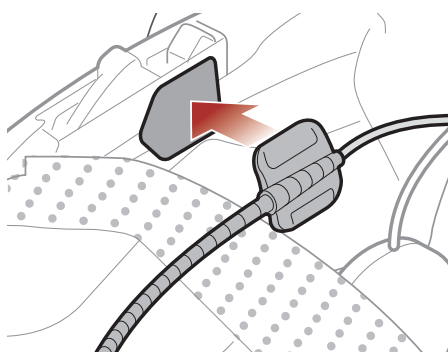

3. Adjust the head of the microphone so that the tab is facing away from your mouth.

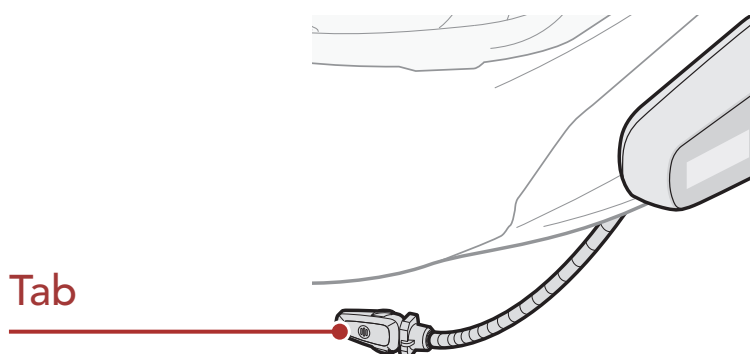

4. Align the arrows on the microphone and speaker cables and insert the microphone cable into the speaker cable.

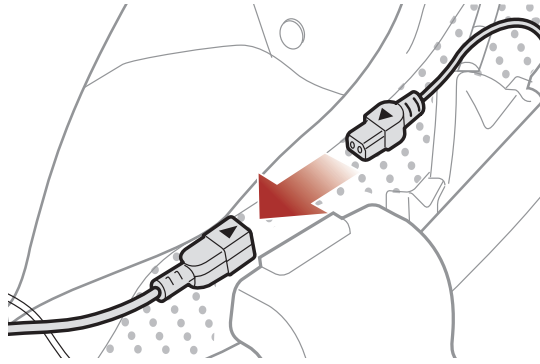

5. Insert the speaker connector into the speaker port to connect it to the main unit.

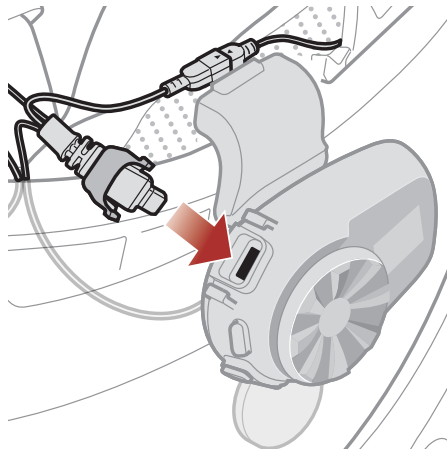

6. Close the cover of the speaker cable to lock the cable to the port.

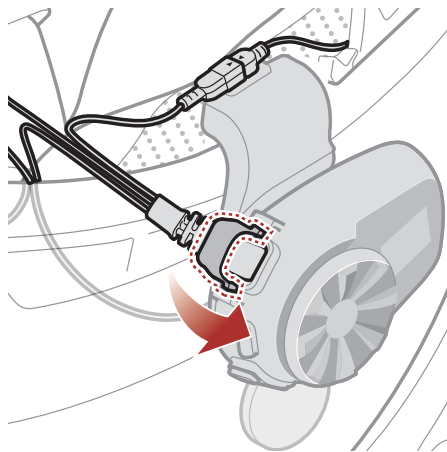

Note: You can use the boom microphone holder after attaching the hook and loop fastener for boom microphone holder on it to ensure secure installation.

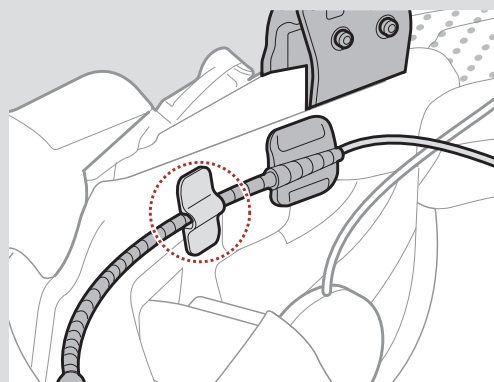

2.3.2 Installing the Wired Microphone

If you have a full face helmet, you can use the wired microphone.

1. Attach the included hook and loop fastener for wired microphone to the inside of the helmet's chin guard.

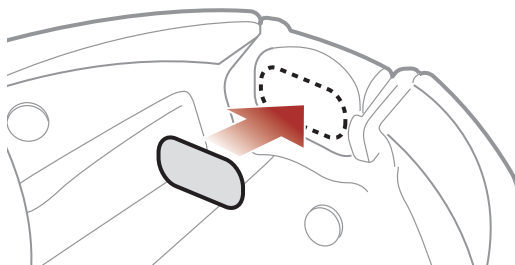

2. Attach the wired microphone to the hook and loop fastener for wired microphone.

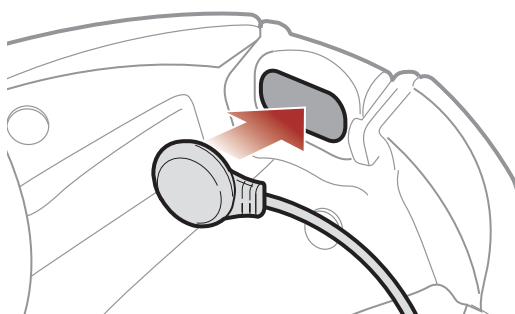

3. Align the arrows on the microphone and speaker cables and insert the microphone cable into the speaker cable.

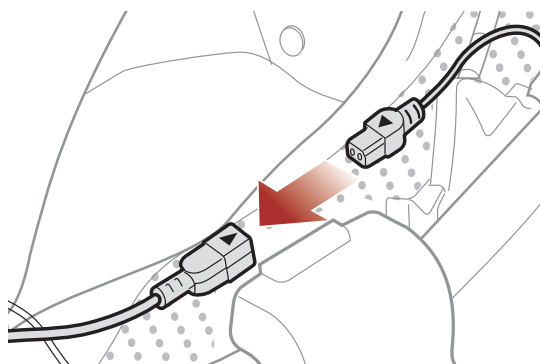

4. Insert the speaker connector into the speaker port to connect it to the main unit.

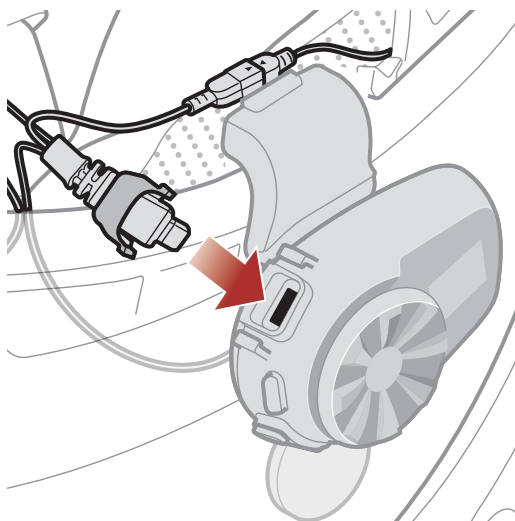

5. Close the cover of the speaker cable to lock the cable to the port.

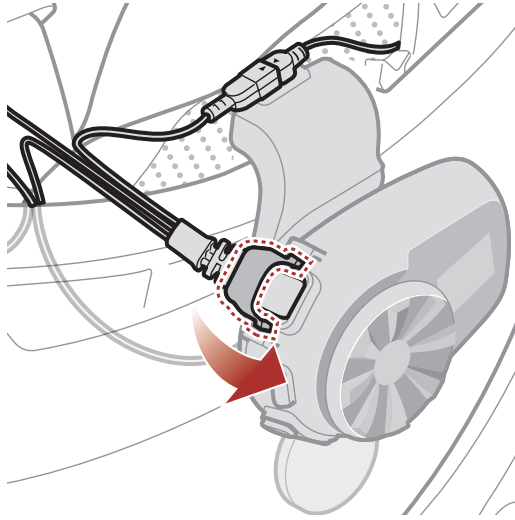

3. GETTING STARTED

3.1 Buttons

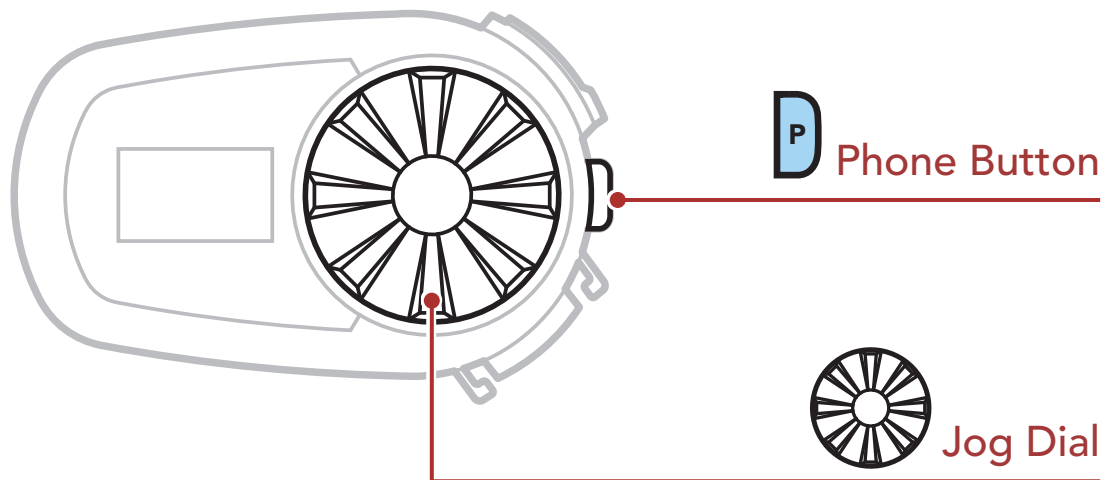

3.2 Downloadable Sena Software

3.2.1 SENA MOTORCYCLES App

By simply pairing your phone with your headset, you can use the **SENA MOTORCYCLES App** for quicker, easier set up and management.

	SENA MOTORCYCLES <ul style="list-style-type: none">• Device configuration setting
---	--

- Download the **SENA MOTORCYCLES App** on **Google Play Store** or **App Store**.

3.2.2 Sena Device Manager

The **Sena Device Manager** allows you to upgrade the firmware and configure its settings directly from your PC or Apple computer. Download the **Sena Device Manager** from **sena.com**.

[Click Here to Visit sena.com](https://www.sena.com)



NOTICE



- This **User Guide (Version 2.0)** explains how to operate the 5S with **firmware version 2.0 or higher**.
- For the operation of the 5S with **a firmware version lower than 2.0**, refer to the **5S User Guide (Version 1.0.0)**.



3.3 Legend

 **Tap** button/Jog Dial the specified number of times

 **Press and Hold** button/Jog Dial for the specified amount of time

   **Rotate** Jog Dial clockwise (right) or counterclockwise (left).

   **Rotate while Pressing** Jog Dial clockwise (right) or counterclockwise (left).

  **Audible prompt**

3.4 Powering On and Off

Powering On

 =   

 = 

Powering Off

 =   

 = 

3.5 Charging

Charging the Headset

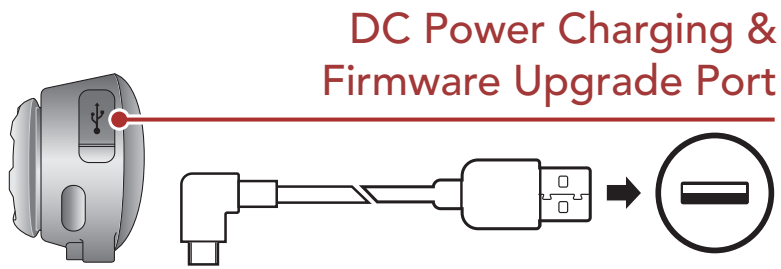

The headset will be fully charged in about 1.5 hours. (The charging time may vary depending on the charging method.)

Note:

- Any 3rd party USB charger can be used with Sena products if the charger is approved by either the FCC, CE, IC, or other locally approved agencies.
- Use of a non-approved charger may cause fire, explosion, leakage, and other hazards which may also reduce the life time or performance of the battery.
- The **5S** is compatible with 5 V input USB-charged devices only.

3.6 Checking the Battery Level

LCD Display

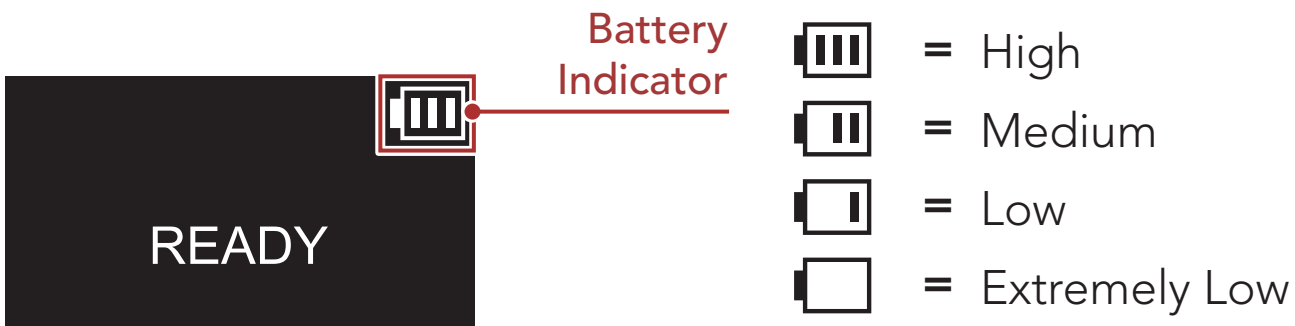

Note: When the battery is low while in use, you will hear a voice prompt saying **“Low battery”**.

3.7 Volume Adjustment

You can raise or lower the volume by rotating the **Jog Dial** clockwise or counterclockwise. Volume is set and maintained independently at different levels for each audio source (i.e., phone, intercom), even when the headset is rebooted.

Volume Up

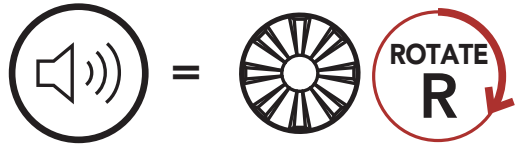

Volume Down

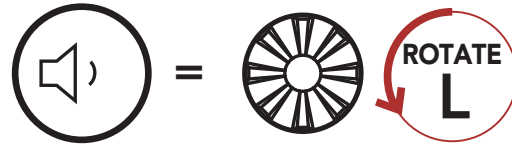

4. PAIRING THE HEADSET WITH OTHER BLUETOOTH DEVICES

When using the headset with other Bluetooth devices for the first time, they will need to be “paired.” This enables them to recognize and communicate with one another whenever they are within range.

The headset can pair with multiple Bluetooth devices such as a mobile phone, GPS, MP3 player or Sena SR10 Two-Way Radio Adapter via **Mobile Phone Pairing, Second Mobile Phone Pairing and GPS Pairing**. The headset can also be paired with up to three other Sena headsets.

Pairs with up to Three Sena Headsets

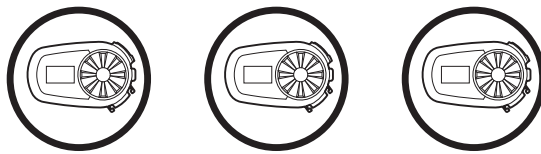

Also Pairs with:

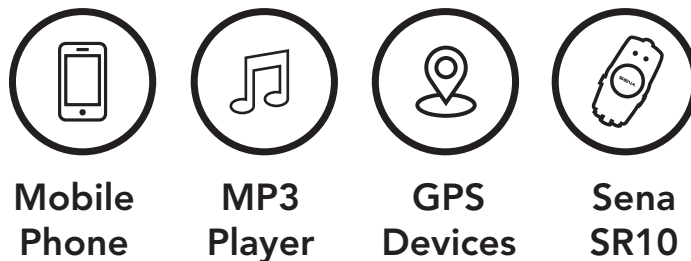

4.1 Phone Pairing

There are three ways to pair the phone.

4.1.1 Initially Pairing the 5S

The headset will automatically enter the phone pairing mode when you initially turn on the headset or in the following situations:

- Rebooting after executing the **Factory Reset** feature; or
- Rebooting after executing the **Delete All Pairings** feature.

1. Press and hold the **Phone Button** and **Jog Dial** for **1 second**.

Phone Pairing

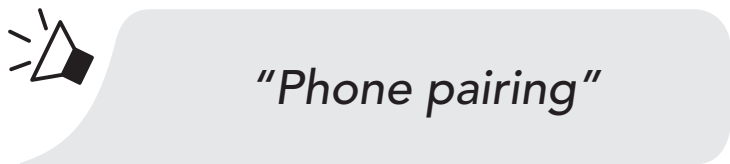
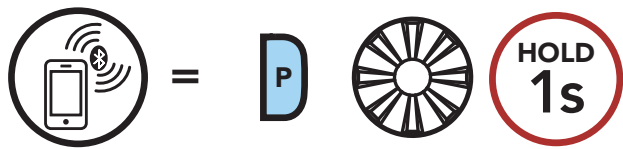

2. With your mobile phone in Bluetooth-pairing mode, select **Sena 5S** in the list of devices detected.
3. If your mobile phone asks for a PIN, enter 0000.

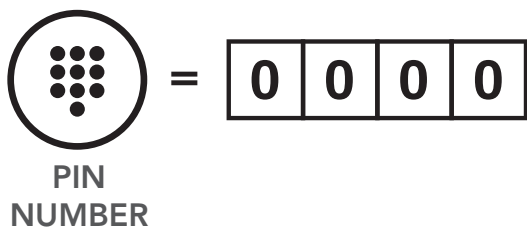

Note:

- The phone pairing mode lasts for **3 minutes**.
- To cancel phone pairing, tap the **Phone Button** or **Jog Dial**.

4.1.2 Pairing When the 5S is Turned Off

1. While the headset is off, press and hold the **Phone Button** and the **Jog Dial** until you hear a voice prompt, **"Phone pairing"**.

Phone Pairing

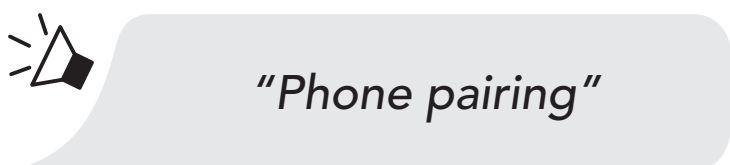
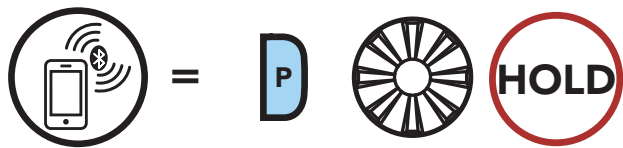

2. With your mobile phone in Bluetooth-pairing mode, select **Sena 5S** in the list of devices detected.
3. If your mobile phone asks for a PIN, enter 0000.

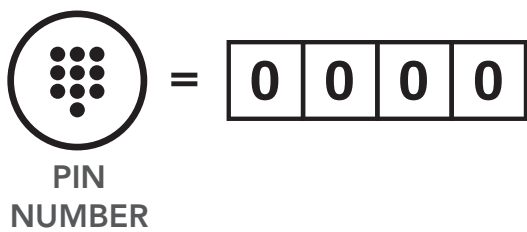

4.1.3 Pairing When the 5S is Turned On

1. Press and hold the **Phone Button** for **5 seconds** when the **5S** is turned on.

Phone Pairing

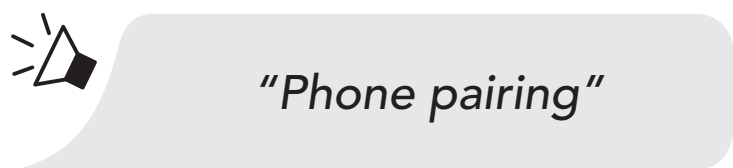
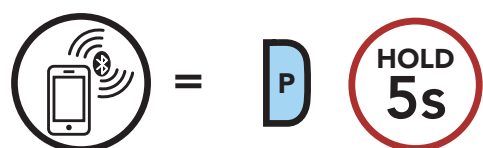

2. With your mobile phone in Bluetooth-pairing mode, select **Sena 5S** in the list of devices detected.
3. If your mobile phone asks for a PIN, enter 0000.

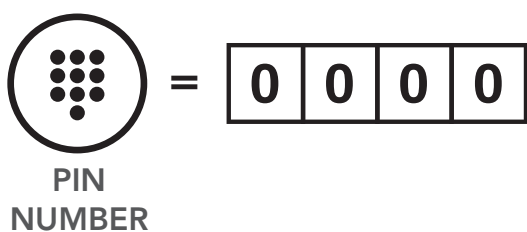

4.2 Second Mobile Phone Pairing - Second Mobile Phone, GPS, and SR10

1. Execute **Second Mobile Phone Pairing**.

Second Mobile Phone Pairing

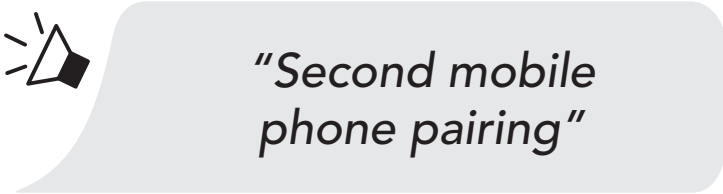
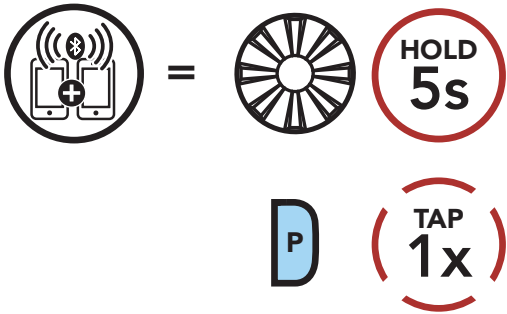

2. With your mobile phone in Bluetooth-pairing mode, select **Sena 5S** in the list of devices detected.

3. If your Bluetooth device asks for a PIN, enter 0000.

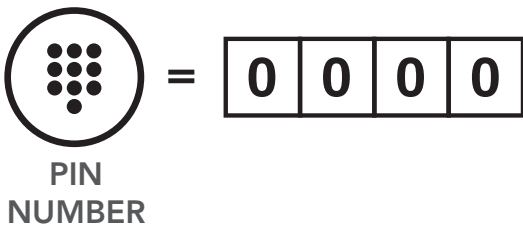

4.3 Advanced Selective Pairing: Hands-Free or A2DP Stereo

Phone Pairing allows the headset to establish two Bluetooth profiles: **Hands-Free** or **A2DP Stereo**. **Advanced Selective Pairing** allows the headset to separate the profiles to enable connection with two devices.

4.3.1 Phone Selective Pairing - Hands-Free Profile

1. Execute **Phone Selective Pairing**.

Phone Selective Pairing

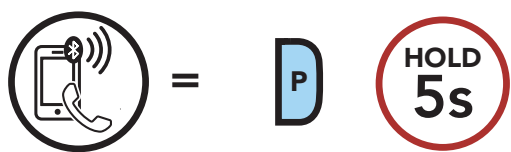

"Phone selective pairing"



=



2. With your mobile phone in Bluetooth-pairing mode, select **Sena 5S** in the list of devices detected.

3. If your mobile phone asks for a PIN, enter 0000.

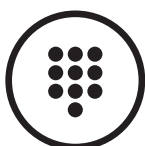

=



PIN
NUMBER

4.3.2 Media Selective Pairing - A2DP Profile

1. Execute **Media Selective Pairing**.

Media Selective Pairing

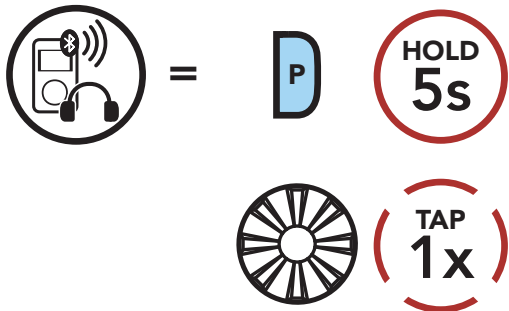

"Media selective pairing"



2. With your mobile phone in Bluetooth-pairing mode, select **Sena 5S** in the list of devices detected.

3. If your mobile phone asks for a PIN, enter 0000.

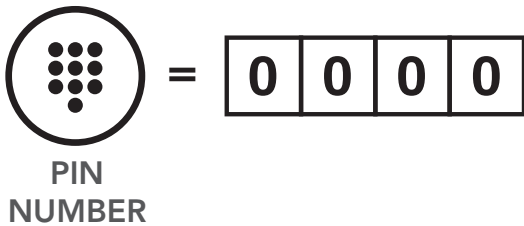

PIN
NUMBER

4.4 GPS Pairing

1. Execute **GPS Pairing**.

GPS Pairing

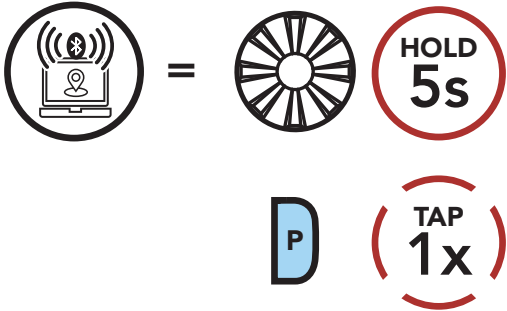

"Second mobile phone pairing"

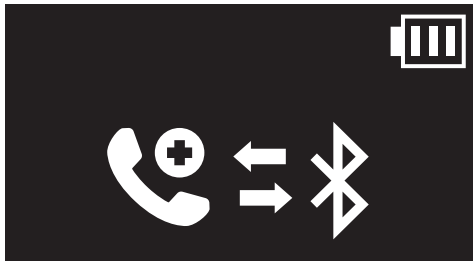

"GPS pairing"

2. With your Bluetooth device on the GPS navigation screen, select **Sena 5S** in the list of devices detected.

3. If your Bluetooth device asks for a PIN, enter 0000.

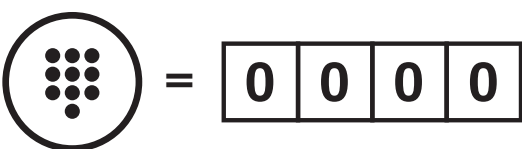

PIN
NUMBER

Note: If you pair your GPS device via GPS Pairing, its instruction will not interrupt your intercom conversations, but overlay with them. Bluetooth intercom conversations will be interrupted by GPS instructions.

5. MOBILE PHONE USAGE

5.1 Making and Answering Calls

LCD Display

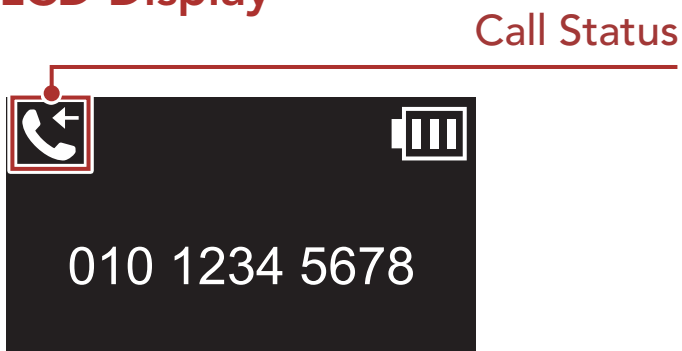

- = Incoming Call
- = Outgoing call
- = On the Phone Call
- = Reject a call

Answer a Call

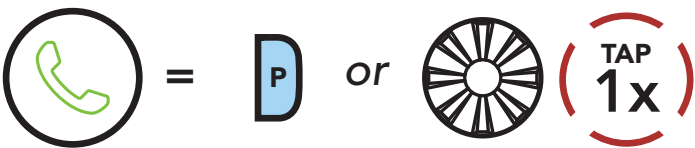

Reject a Call

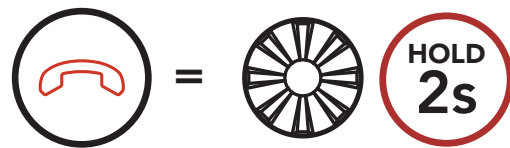

Make Call with Voice Dialer

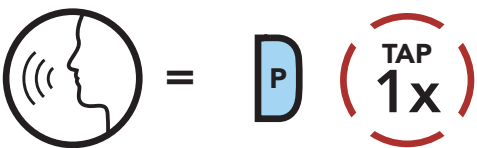

End a Call

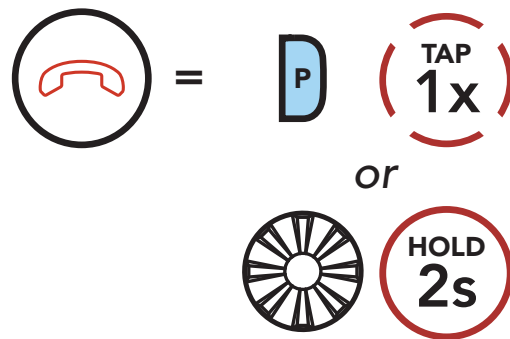

Note: If you have a GPS device connected, you will not hear its voice navigations during a phone call.

5.2 Speed Dialing

5.2.1 Assigning Speed Dial Presets

Speed Dial Presets could be assigned in the settings menu, accessible through **Sena Device Manager** or **SENA MOTORCYCLES App**.

5.2.2 Using Speed Dial Presets

1. Enter into the **Speed Dial** menu.

Enter Speed Dial Mode

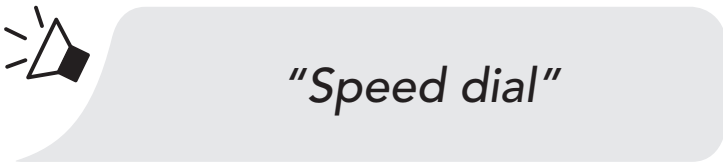
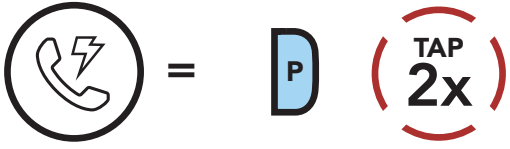

2. Navigate between the **Speed Dial Preset**.

Navigate Forward or Backward through Speed Dial Preset Numbers

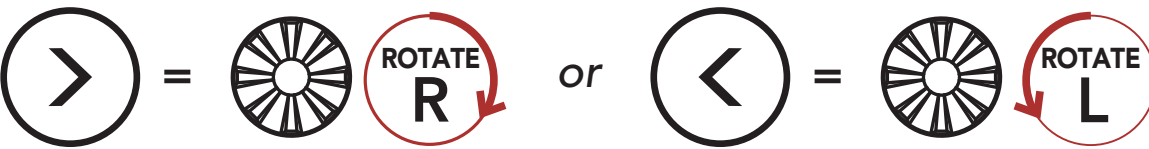

3. Call one of your **Speed Dial Presets**.

Call a Speed Dial Preset Number

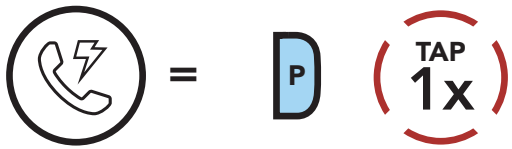

"Speed dial (#)"

4. Redial the last number called.

Redial Last Number

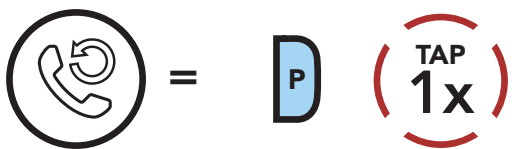

"Last number redial"

6. STEREO MUSIC

6.1 Playing Music with Bluetooth Devices

1. Play or pause music.

Play/Pause Music

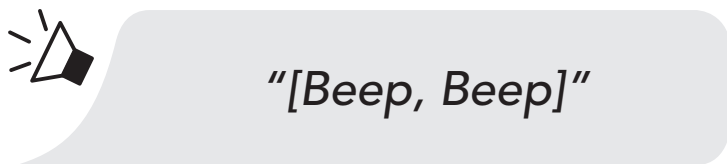
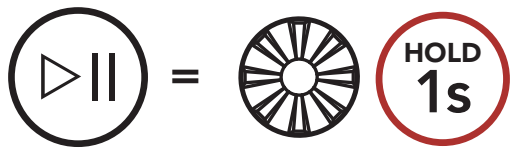

2. Adjust the volume.

Volume Up/Down



or

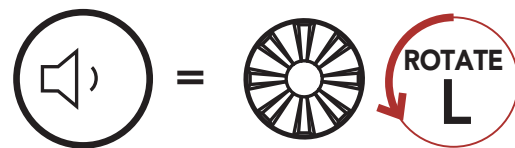

3. Track forward or back.

Track Forward/Backward



or

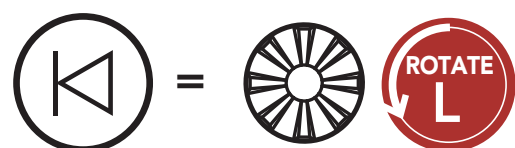

6.2 Music Sharing

You can start sharing music with an intercom friend using Bluetooth stereo music during a two-way intercom conversation. When you terminate music sharing, you can go back to the intercom conversation. To start or terminate sharing music, press the **Jog Dial** for **1 second** during an intercom conversation until you hear a double beep. To track forward or track back, rotate while pressing the **Jog Dial clockwise** or **counterclockwise**.

Music Sharing On/Off

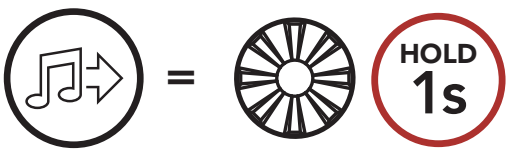

“[Beep, Beep]”

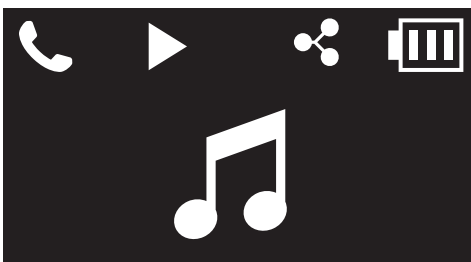

Note:

- Both you and your intercom friend can remotely control music playback such as track forward and track back.
- Music sharing will be paused when you are using your mobile phone or listening to GPS instructions.
- When Audio Multitasking is enabled, if an intercom call is made when you are listening to music, music sharing will not work.

7. BLUETOOTH INTERCOM

Up to three people can communicate via intercom with the headset simply by pairing their headsets.

Pairing with Intercom Friends

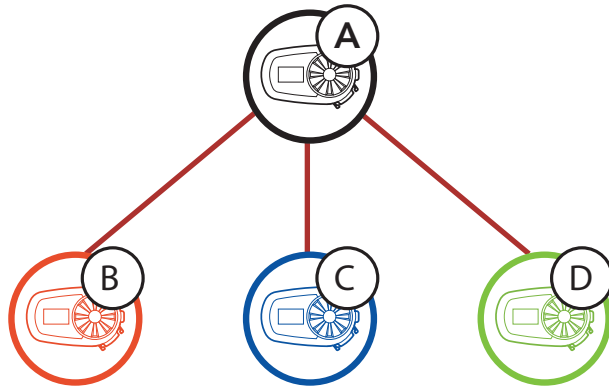



7.1 Intercom Pairing

There are two ways to pair the headset.

7.1.1 Using the Smart Intercom Pairing (SIP)

SIP allows you to quickly pair with your friends for intercom communication by scanning the QR code on the **SENA MOTORCYCLES App** without remembering the button operation.

1. Pair the mobile phone with the headset.
2. Open the **SENA MOTORCYCLES App** and tap  (**Smart Intercom Pairing Menu**).
3. Scan the **QR code** displayed on your friend (**B**)'s mobile phone.
 - Your friend (**B**) can display the QR code on the mobile phone by tapping  > **QR code** () on the **SENA MOTORCYCLES App**.

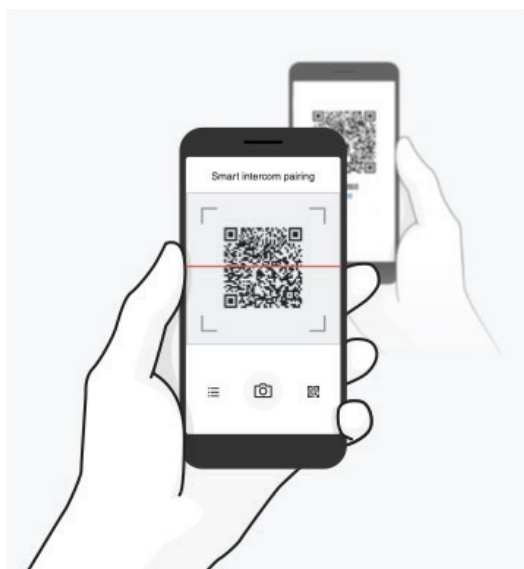

4. Tap **Save** and check that your friend **(B)** is paired with **you (A)** correctly.
5. Tap **Scan** (📷) and repeat steps 3-4 to pair with **Intercom Friends (C)** and **(D)**.

Note: The **Smart Intercom Pairing (SIP)** is not compatible with Sena products that use **Bluetooth 3.0 or below**.

7.1.2 Using the Button

1. Press and hold the **Jog Dials** of two headsets for **5 seconds** until you hear a voice prompt, **"Intercom pairing"**.

Pairing Headset A with Headset B

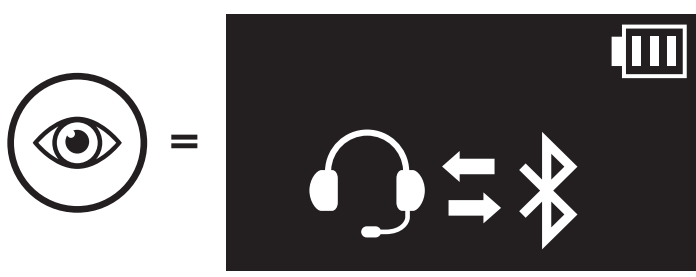
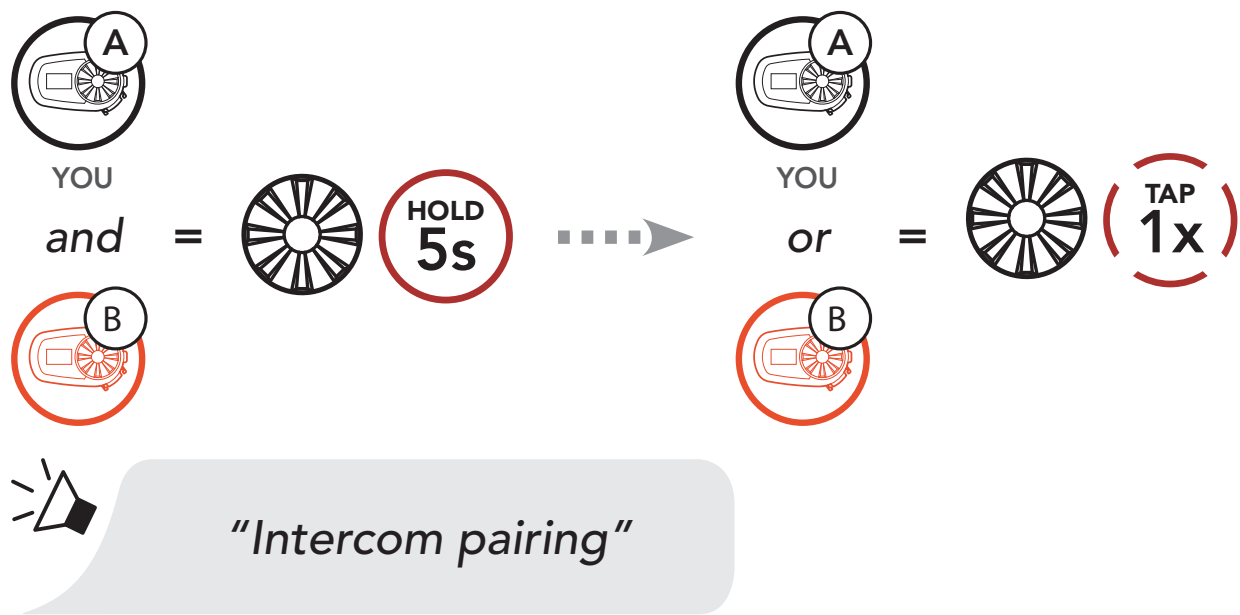

2. Repeat step 1 to pair with **Intercom Friends C & D**.

Last-Come, First-Served

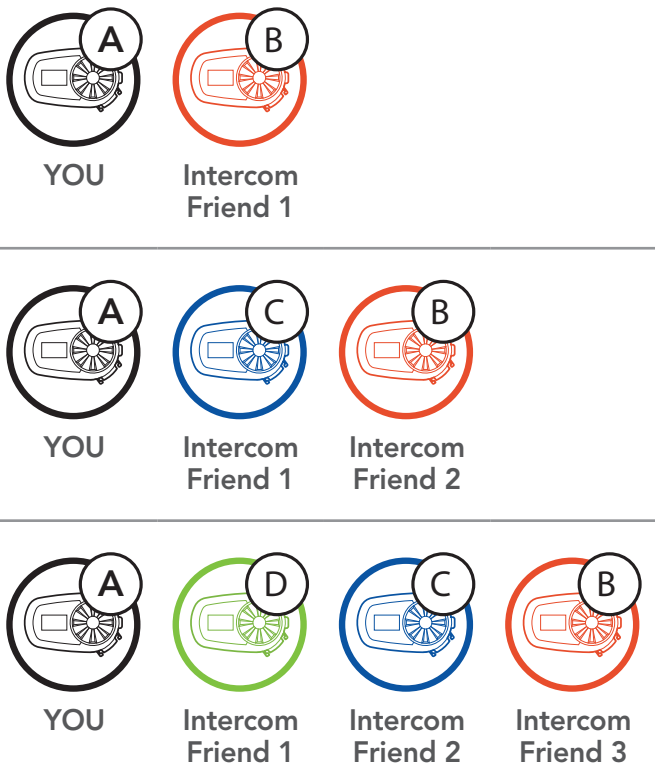

7.2 Two-Way Intercom

Intercom Conversation with Intercom Friend



You can start or end an intercom conversation with an Intercom Friend by tapping the **Jog Dial**.

1. Tap once for Intercom **Friend 1**.

Start/End with Intercom Friend 1

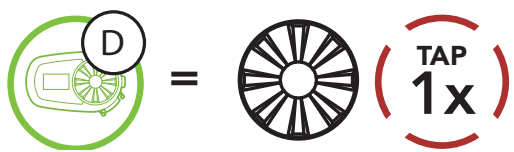

2. Tap twice for Intercom **Friend 2**.

Start/End with Intercom Friend 2

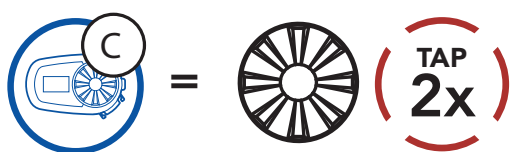

3. Tap three times for Intercom **Friend 3**.

Start/End with Intercom Friend 3

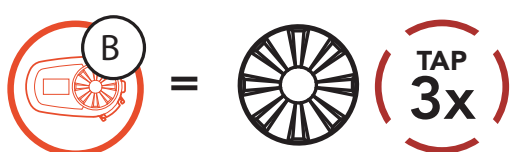

7.3 Universal Intercom

Universal Intercom allows you to have two-way intercom conversations with users of non-Sena Bluetooth headsets. You can pair your headset with only one non-Sena headset at a time. The intercom distance depends on the performance of the Bluetooth headset to which it is connected. When a non-Sena Bluetooth headset is paired with the Sena headset, if another Bluetooth device is paired via **Second Mobile Phone Pairing**, it will be disconnected.

1. Execute **Universal Intercom** in the **Headset Configuration Menu**.

Access Universal Intercom in the Configuration Menu

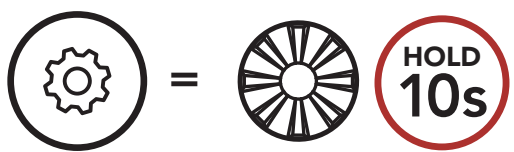

"Configuration menu"

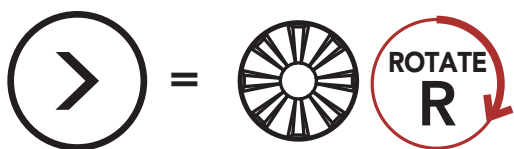

"Universal intercom pairing"

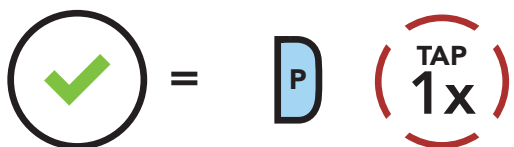
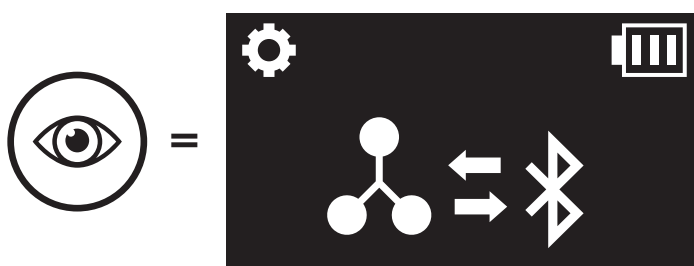

2. Put the non-Sena Bluetooth headset in Pairing Mode. The headset will automatically pair with a non-Sena Bluetooth headset.

8. FUNCTION PRIORITY AND FIRMWARE UPGRADES

8.1 Function Priority

The **5S** operates in the following order of priority:

- (highest)** Mobile phone
- Intercom
- Music sharing via Bluetooth stereo music
- (lowest)** Bluetooth stereo music

A lower priority function is always interrupted by a higher priority function.

Note: If you select music as the audio source priority, the order of priority will change as below:

- (highest)** Mobile phone
- Bluetooth stereo music
- Intercom
- (lowest)** Music sharing via Bluetooth stereo music

8.2 Firmware Upgrades

The headset supports firmware upgrades. You can upgrade the firmware using the **Sena Device Manager**. Please visit **sena.com** to check for the latest software downloads.

[Click Here to Visit sena.com](https://www.sena.com)

9. CONFIGURATION SETTING

9.1 Headset Configuration Setting

Access the Configuration Menu

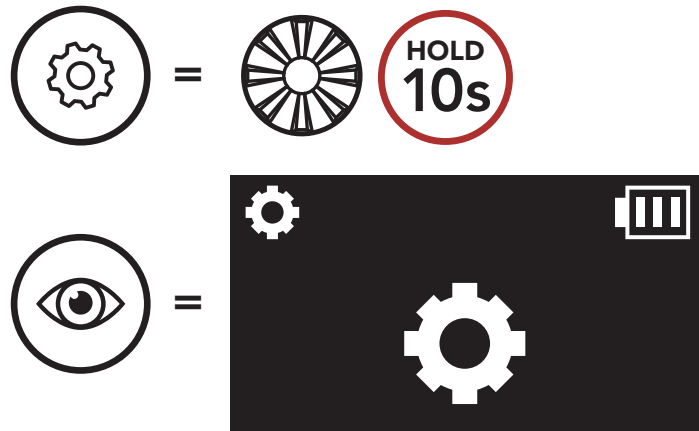

Navigate Between Menu Options

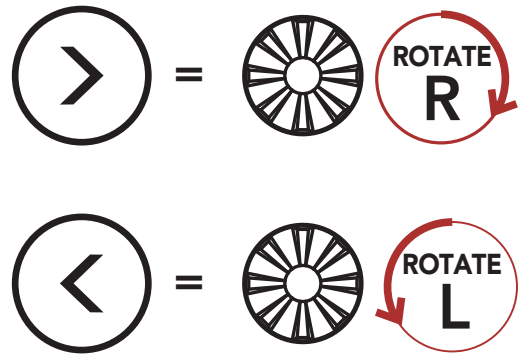

Execute Menu Options

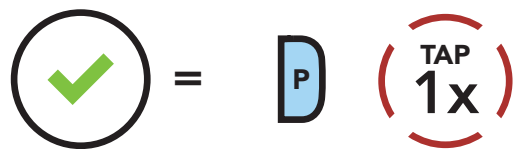

Headset Configuration Menu

Voice Configuration Menu	Tap the Phone Button
Delete All Pairings	Execute
Remote Control Pairing	Execute
Universal Intercom Pairing	Execute
Exit	Execute

9.1.1 Delete All Pairings

Delete All Bluetooth Pairing Information stored in the headset.

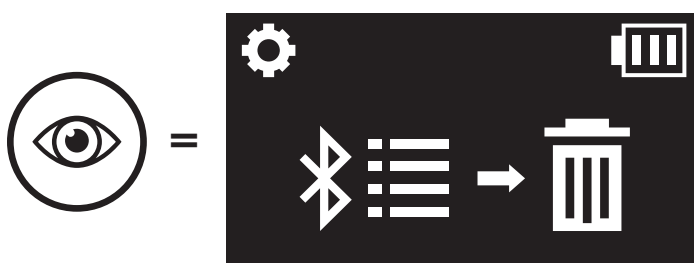

9.1.2 Remote Control Pairing

You can remotely control the headset using **Sena** Remote Control devices (sold separately).

1. Turn on the headset and the Remote Control device.
2. Execute **Remote Control Pairing**.

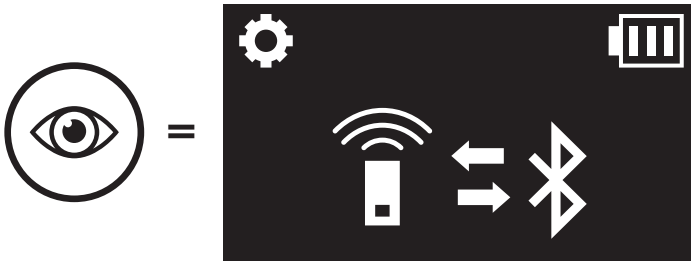

3. Enter pairing mode in the Remote Control device. The headset will automatically connect with the Remote Control device in pairing mode.

9.2 Software Configuration Setting

You can change the settings of the headset through the **Sena Device Manager** or the **SENA MOTORCYCLES App**.



9.2.1 Speed Dial

Assign phone numbers for speed dialing to make a phone call quickly.

9.2.2 Headset Language

You can select the device language. The selected language is maintained even when the headset is rebooted.

9.2.3 Audio Equalizer (Default: Off)

You can use the **Audio Equalizer** to increase/decrease the decibel level of different frequency ranges of audio.

Balance will adjust all of the frequency ranges to be the same volume level (0 dB). **Bass Boost** will increase the bass range of audio (20 Hz - 250 Hz). **Mid Boost** will increase the mid range of audio (250 Hz - 4 kHz). **Treble Boost** will increase the high range of audio (4 kHz - 20 kHz).

9.2.4 VOX Phone (Default: Enable)

If this feature is enabled, you can answer incoming calls by voice. When you hear a ringtone for an incoming call, you can answer the phone by saying a word such as **"Hello"** loudly or by blowing air into the microphone. **VOX Phone** is temporarily disabled if you are connected to intercom. If this feature is disabled, you have to tap the **Jog Dial** or the **Phone Button** to answer an incoming call.

9.2.5 VOX Intercom (Default: Disable)

If **VOX Intercom** is enabled, you can initiate an intercom conversation with the last connected intercom friend by voice. When you want to start intercom, say a word such as **"Hello"** loudly or blow air into the microphone. If you start an intercom conversation by voice, the intercom terminates automatically when you and your intercom friend remain silent for 20 seconds. However, if you manually start an intercom conversation by tapping the **Jog Dial**, you have to terminate the intercom conversation manually. However, if you start the intercom by voice and end it manually by tapping the **Jog Dial**, you will not be able to start intercom by voice temporarily. In this case, you have to tap the **Jog Dial** to restart the intercom. This is to prevent repeated unintentional intercom connections by strong wind noise. After rebooting the headset, you can start the intercom by voice again.

9.2.6 Audio Source Priority (Default: Intercom)

Audio Source Priority allows you to select the priority between the intercom and music (which includes GPS app instructions and message notifications) from a smartphone. If the intercom is selected as the audio source priority, your music will be interrupted during an intercom conversation. If music is selected as the audio source priority, intercom conversations will be interrupted while your music is heard.

Note: Audio Source Priority is active only when **Audio Multitasking** is disabled.

9.2.7 Audio Multitasking™ (Default: Disable)

Audio Multitasking allows you to hear the audio from two features simultaneously. When **Audio Multitasking** is enabled, phone calls, GPS instructions, and intercom conversations can be overlaid with audio from the music or GPS app instructions from a smartphone in the background with reduced volume. Increasing or decreasing the volume of the audio in the foreground will also increase or decrease the volume of the overlaid audio in the background. The volume of the foreground audio can be adjusted using the headset. How much background audio that is heard can be adjusted using the **Sena Device Manager** or the **SENA MOTORCYCLES App**. **HD Intercom**, **HD Voice**, and **Audio Source Priority** become disabled temporarily when **Audio Multitasking** is enabled.

Foreground and Background Combination Table

Model	Foreground*			Background**
	Phone	GPS	Intercom	Music or Smart Navi
5S	<input type="radio"/> ^A	<input type="radio"/> ^A		
		<input type="radio"/>	<input type="radio"/>	
			<input type="radio"/> ^B	<input type="radio"/> ^B
		<input type="radio"/>		<input type="radio"/>

* Two audio sources in the foreground can be heard simultaneously with the same volume level.

** Only one background source can be heard at a time while listening to an audio source in the foreground.

A. GPS instructions can be heard during phone calls and the volume level of both audio sources can be adjusted using the headset.

B. GPS app directions will be heard in the background during intercom conversations.

Note:

- **Audio Multitasking** will be activated during two-way intercom conversations with a headset that also supports this feature.
- When **Audio Multitasking** is disabled, the background audio source will return to its independent volume level.
- **Audio Multitasking** has limited usage for iOS devices.
- For **Audio Multitasking** to work properly, you need to power the headset off and on. Please restart the headset.
- Some GPS devices may not support this feature.

9.2.8 Background Volume (Default: Level 5)

The **Background Volume** can be adjustable only when the **Audio Multitasking** turns on. Level 9 is the highest volume and 0 is the lowest.

9.2.9 HD Intercom (Default: Enable)

HD Intercom enhances the two-way intercom audio from normal quality to HD quality. If this feature is disabled, the two-way intercom audio will change to normal quality.

Note:

- The intercom distance of **HD Intercom** is relatively shorter than that of normal intercom.
- **HD Intercom** will become disabled temporarily when **Audio Multitasking** is enabled.

9.2.10 HD Voice (Default: Enable)

HD Voice allows you to communicate in high-definition during phone calls. This feature increases the quality so that the audio will be crisp and clear during phone call conversations.

If this feature is enabled, incoming phone calls will interrupt intercom conversations and audio from the SR10 will not be heard during intercom conversations.

Note:

- Refer to the manufacturer of your Bluetooth device that will be connected to the headset to see if it supports **HD Voice**.
- **HD Voice** is active only when **Audio Multitasking** is disabled.

9.2.11 Voice Prompt (Default: Enable)

You can disable **Voice Prompts** by software configuration settings, but the following voice prompts are always on.

- Headset configuration settings menu, battery level indicator, speed dial

9.2.12 Advanced Noise Control™ (Always On)

The background noise is reduced during an intercom conversation.

10. TROUBLESHOOTING

Please visit [sena.com](https://www.sena.com) for answers to frequently asked questions. This detailed online FAQ section deals with troubleshooting, illustrates case studies and contains tips on using the headset.

[Click Here to Visit sena.com](https://www.sena.com)

10.1 Fault Reset

When the headset is not working properly, you can easily reset the unit:

1. Locate the **pinhole reset button** below on the back of the main unit.
2. Gently insert a paperclip into the hole and tap the **Fault Reset Button** with light pressure.

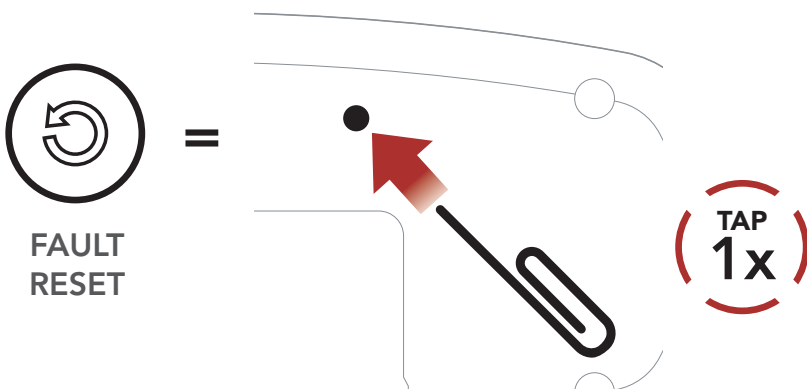

3. The headset will shut down.

Note: Fault Reset will not restore the headset to factory default settings.

10.2 Factory Reset

To erase all of your settings and start fresh, the headset can be restored to factory default settings using the **Factory Reset** feature.

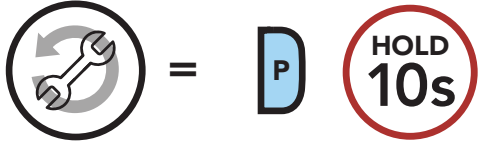

"Factory reset"

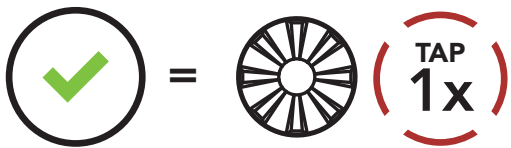

"Headset reset, good-bye"

Note: If you press the **Phone Button** or do not press the **Jog Dial** within **5 seconds**, the reset attempt is canceled and the headset returns to standby mode. You will hear a voice prompt saying **"Canceled"**.



Copyright © 2022 Sena Technologies, Inc.

All rights reserved.

© 1998–2022 Sena Technologies, Inc. All rights reserved.

Sena Technologies, Inc. reserves the right to make any changes and improvements to its product without providing prior notice.

Sena™ is a trademark of Sena Technologies, Inc. or its subsidiaries in the USA and other countries. SF1™, SF2™, SF4™, SFR™, SRL™, Momentum™, Momentum INC™, Momentum Lite™, Momentum Pro™, Momentum INC Pro™, Momentum EVO™, Cavalry™, Latitude SR™, Latitude SX™, Latitude S1™, 30K™, 33i™, 50S™, 50R™, 50C™, 5S™, 5R™, 5R LITE™, 20S EVO™, 20S™, 10S™, 10C™, 10C PRO™, ProRide EVO™, 10C EVO™, 10U™, 10Upad™, 10R™, ACS10™, ACS-RAM™, C1™, 3S™, 3S PLUS™, SMH5™, SMH5-FM™, SMH5 MultiCom™, SMH10™, SMH10R™, SPH10™, SPH10H-FM™, Savage™, Prism Tube WiFi™, Prism™, Bluetooth Audio Pack for GoPro®, Impulse™, R1™, R1 EVO™, R1 EVO CS™, R2™, R2 EVO™, R2X™, M1™, M1 EVO™, RUMBA™, RC1™, RC3™, RC4™, Stryker™, Handlebar Remote™, Wristband Remote™, PowerPro Mount™, Powerbank™, FreeWire™, WiFi Docking Station™, WiFi Sync Cable™, WiFi Adapter™, +mesh™, +Mesh Universal™, MeshPort Blue™, MeshPort Red™, MeshPort Black™, Econo™, OUTRUSH™, OUTRUSH R™, OUTSTAR™, OUTSTAR S™, OUTFORCE™, OUTRIDE™, EcoCom™, Parani A10™, Parani A20™, Parani M10™, pi™, Snowtalk™, Snowtalk2™, SR10™, SR10i™, SM10™, SPIDER RT1™, SPIDER ST1™, X1™, X1 Pro™, X1S™, Expand™, Expand Boom™, Bluetooth Mic & Intercom™, Tufftalk™, Tufftalk Lite™, Tufftalk M™ are trademarks of Sena Technologies, Inc. or its subsidiaries. These trademarks may not be used without the express permission of Sena.

GoPro® is a registered trademark of Woodman Labs of San Mateo, California. Sena Technologies, Inc. ("Sena") is not affiliated with Woodman Labs, Inc. The Sena Bluetooth Pack for GoPro® is an aftermarket accessory specially designed and manufactured by Sena Technologies, Inc. for the GoPro® Hero3 and Hero4 allowing for Bluetooth capabilities.

The Bluetooth® word mark and logos are owned by the Bluetooth SIG, Inc. and any use of such marks by Sena is under license. iPhone® and iPod® touch are registered trademarks of Apple Inc.

Address: 152 Technology Drive Irvine, CA 92618