

**SENA**

**30K**

**MOTORCYCLE BLUETOOTH  
COMMUNICATION SYSTEM  
WITH MESH INTERCOM™**



**HD SPEAKERS**

**CLICK  
ANY  
SECTION  
TO  
BEGIN**

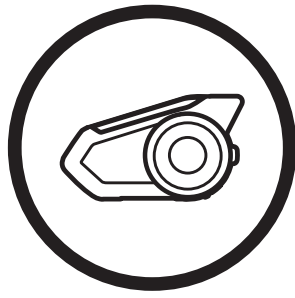

**ABOUT THE  
HEADSET**

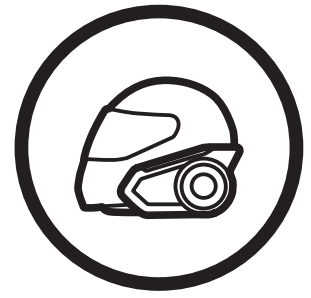

**INSTALLING  
THE HEADSET**



**GETTING  
STARTED**

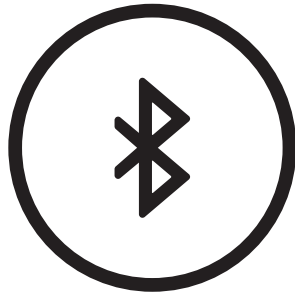

**PAIRING WITH  
DEVICES**



**MOBILE  
PHONE USAGE**



**STEREO  
MUSIC**

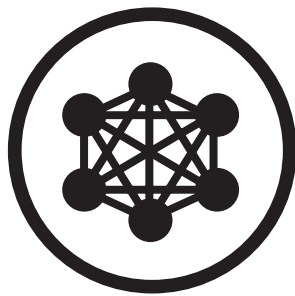

**MESH  
INTERCOM**

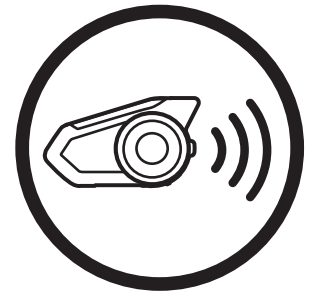

**BLUETOOTH  
INTERCOM**



**AMBIENT MODE**



**VOICE  
COMMAND**

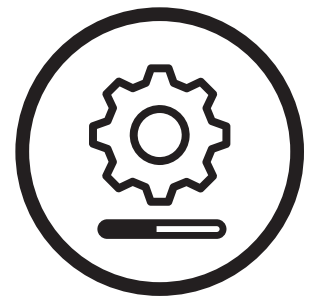

**FIRMWARE  
UPGRADES**

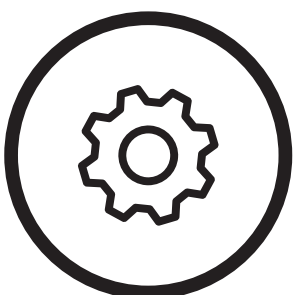

**CONFIGURATION**



**TROUBLE-  
SHOOTING**

# TABLE OF CONTENTS

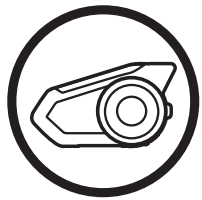

## **1. ABOUT THE MOTORCYCLE BLUETOOTH COMMUNICATION SYSTEM WITH MESH INTERCOM™ 7**

---

- 1.1 Product Details 7**
  - 1.1.1 Headset Main Unit 7
  - 1.1.2 Universal Clamp Kit 7
- 1.2 Package Contents 8**

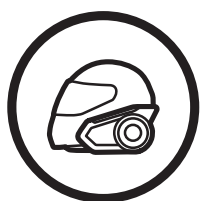

## **2. INSTALLING THE HEADSET ON YOUR HELMET 10**

---

- 2.1 Helmet Installation 10**
- 2.2 Using the Glued Surface Mounting  
Adapter 13**
- 2.3 Switching the Microphone 15**
  - 2.3.1 Wired Boom Microphone 16
  - 2.3.2 Wired Microphone 16
- 2.4 Earbuds 17**
- 2.5 External Mesh Intercom Antenna 17**

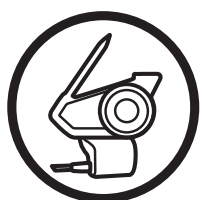

## **3. GETTING STARTED 18**

---

- 3.1 Button Functions 18**
- 3.2 Downloadable Sena Software 18**
  - 3.2.1 Sena Motorcycles App 18
  - 3.2.2 Sena Device Manager 19
- 3.3 Legend 19**
- 3.4 Powering On and Off 20**
- 3.5 Charging 21**
- 3.6 Checking the Battery Level 22**
- 3.7 Volume Adjustment 23**

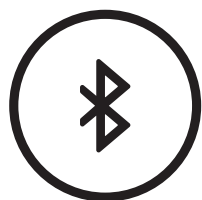

## **4. PAIRING THE HEADSET WITH OTHER BLUETOOTH DEVICES 24**

---

- 4.1 Phone Pairing 24**
  - 4.1.1 Initially Pairing the 30K 24

## TABLE OF CONTENTS CONTINUED

4.1.2	Pairing When the 30K is Turned Off	25
4.1.3	Pairing When the 30K is Turned On	26
4.2	<b>Second Mobile Phone Pairing</b>	<b>26</b>
4.3	<b>Advanced Selective Pairing: Hands-Free or A2DP Stereo</b>	<b>27</b>
4.3.1	Phone Selective Pairing - Hands-Free Profile	28
4.3.2	Media Selective Pairing - A2DP Profile	29
4.4	<b>GPS Pairing</b>	<b>30</b>



## **5. MOBILE PHONE USAGE 31**

---

5.1	<b>Making and Answering Calls</b>	<b>31</b>
5.2	<b>Speed Dialing</b>	<b>32</b>
5.2.1	Assigning Speed Dial Presets	32
5.2.2	Using Speed Dial Presets	32



## **6. STEREO MUSIC 34**

---

6.1	<b>Playing Music with Bluetooth Devices</b>	<b>34</b>
6.2	<b>Music Sharing</b>	<b>35</b>
6.2.1	Bluetooth Intercom Music Sharing	36
6.2.2	Mesh Intercom Music Sharing	36

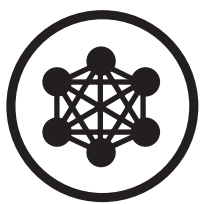

## **7. MESH INTERCOM 38**

---

7.1	<b>What is Mesh Intercom?</b>	<b>38</b>
7.1.1	Open Mesh	39
7.1.2	Group Mesh	40
7.2	<b>Starting Mesh Intercom</b>	<b>41</b>
7.3	<b>Using the Mesh in Open Mesh</b>	<b>41</b>
7.3.1	Channel Setting (Default: channel 1)	42
7.4	<b>Using Mesh in Group Mesh</b>	<b>44</b>
7.4.1	Creating a Group Mesh	44
7.4.2	Joining an Existing Group Mesh	46
7.5	<b>Enable/Disable Mic (Default: Enable)</b>	<b>48</b>
7.6	<b>Toggling Open Mesh/Group Mesh</b>	<b>48</b>
7.7	<b>Mesh Reach-Out Request</b>	<b>49</b>
7.8	<b>Reset Mesh</b>	<b>50</b>

## TABLE OF CONTENTS CONTINUED



<b>8. BLUETOOTH INTERCOM</b>	<b>51</b>
<b>8.1 Intercom Pairing</b>	<b>51</b>
8.1.1 Using the Smart Intercom Pairing (SIP)	51
8.1.2 Using the Button	53
<b>8.2 Last-Come, First-Served</b>	<b>54</b>
<b>8.3 Two-Way Intercom</b>	<b>55</b>
<b>8.4 Multi-Way Intercom</b>	<b>56</b>
8.4.1 Starting a Three-Way Intercom Conference	56
8.4.2 Starting a Four-Way Intercom Conference	58
8.4.3 Ending Multi-Way Intercom	59
<b>8.5 Three-Way Conference Phone Call with Intercom Users</b>	<b>59</b>
<b>8.6 Group Intercom</b>	<b>61</b>
<b>8.7 Mesh Intercom Conference with Bluetooth Intercom Participant</b>	<b>62</b>
<b>8.8 Universal Intercom</b>	<b>64</b>
8.8.1 Two-Way Universal Intercom	66
8.8.2 Multi-Way Universal Intercom	66



<b>9. AMBIENT MODE</b>	<b>68</b>
------------------------	-----------



<b>10. VOICE COMMAND</b>	<b>69</b>
--------------------------	-----------



<b>11. FUNCTION PRIORITY AND FIRMWARE UPGRADES</b>	<b>71</b>
--	-----------

<b>11.1 Function Priority</b>	<b>71</b>
<b>11.2 Firmware Upgrades</b>	<b>71</b>

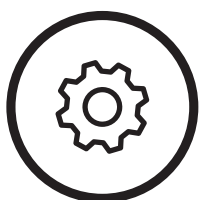

<b>12. CONFIGURATION</b>	<b>72</b>
--------------------------	-----------

<b>12.1 Headset Configuration Setting</b>	<b>72</b>
12.1.1 Delete All Pairings	74
12.1.2 Remote Control Pairing	74

## TABLE OF CONTENTS CONTINUED

<b>12.2 Software Configuration Setting</b>	<b>74</b>
12.2.1 Headset Language	75
12.2.2 Mesh Reach-Out (Default: Disable)	75
12.2.3 Audio Equalizer (Default: Off)	75
12.2.4 VOX Phone (Default: Enable)	75
12.2.5 VOX Intercom (Default: Disable)	76
12.2.6 VOX Sensitivity (Default: 3)	76
12.2.7 Bluetooth Intercom Audio Multitasking (Default: Disabled)	77
12.2.8 Intercom-Audio Overlay Sensitivity (Default: 3)	78
12.2.9 Audio Overlay Volume Management (Default: Disable)	78
12.2.10 HD Intercom (Default: Enable)	78
12.2.11 HD Voice (Default: Enable)	79
12.2.12 Smart Volume Control (Default: Disable)	79
12.2.13 Sidetone (Default: Disable)	80
12.2.14 Voice Prompt (Default: Enable)	80
12.2.15 Advanced Noise Control™ (Default: Enable)	80



<b>13. TROUBLESHOOTING</b>	<b>81</b>
13.1 Fault Reset	81
13.2 Factory Reset	82

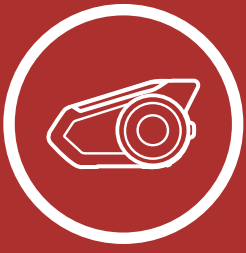

# 1. ABOUT THE MOTORCYCLE BLUETOOTH COMMUNICATION SYSTEM WITH MESH INTERCOM™

Product Details

Package Contents

## 1.1 Product Details

### 1.1.1 Headset Main Unit



### 1.1.2 Universal Clamp Kit

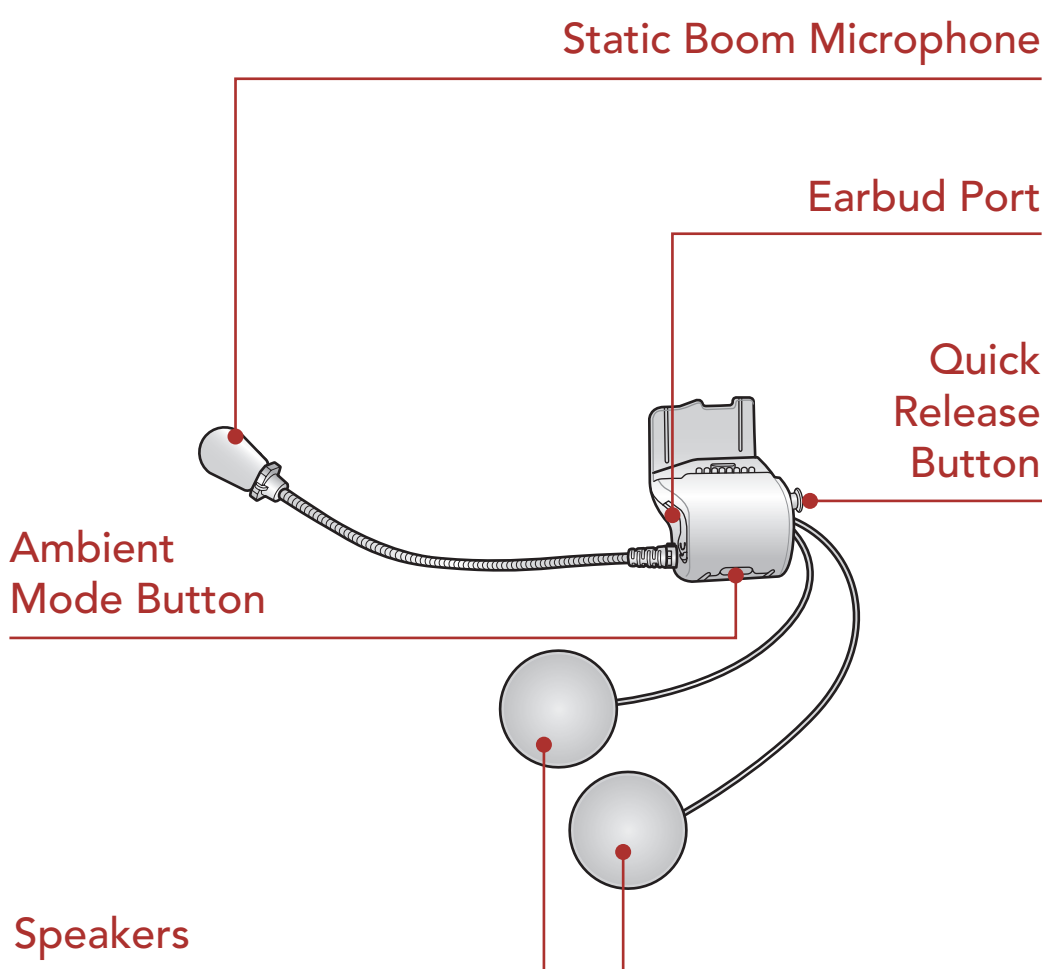







# 1. ABOUT THE MOTORCYCLE BLUETOOTH COMMUNICATION SYSTEM WITH MESH INTERCOM™

Product  
Details

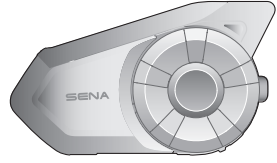
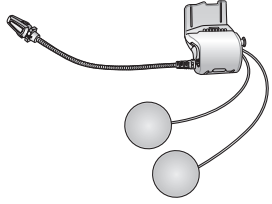
Package  
Contents

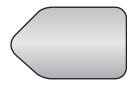
## 1.2 Package Contents

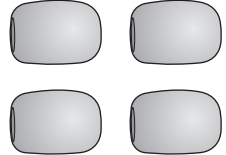
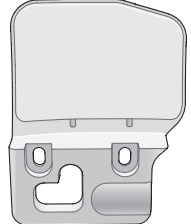
<ul style="list-style-type: none"><li>• 30K Headset Main Unit</li></ul>	
<ul style="list-style-type: none"><li>• Universal Helmet Clamp</li></ul>	
<ul style="list-style-type: none"><li>• Wired Boom Microphone</li></ul>	
<ul style="list-style-type: none"><li>• Wired Microphone</li></ul>	
<ul style="list-style-type: none"><li>• Hook and Loop Fastener for Boom Microphone</li></ul>	
<ul style="list-style-type: none"><li>• Hook and Loop Fastener for Wired Microphone</li></ul>	
<ul style="list-style-type: none"><li>• Microphone Sponges</li></ul>	
<ul style="list-style-type: none"><li>• Glued Surface Mounting Adapter</li></ul>	









# 1. ABOUT THE MOTORCYCLE BLUETOOTH COMMUNICATION SYSTEM WITH MESH INTERCOM™

MENU

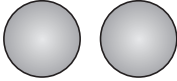
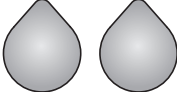
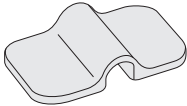
Product  
Details

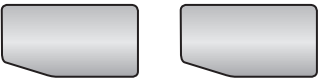
Package  
Contents

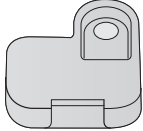
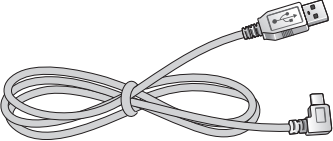
• Speaker Pads	
• Hook and Loop Fasteners for Speakers	
• Boom Microphone Holder	
• Hook and Loop Fastener for Holder	
• Rubber Pads	
• Allen Wrench	
• Speaker Port Cover	
• USB Power & Data Cable (USB-C)	



## 2. INSTALLING THE HEADSET ON YOUR HELMET

### 2.1 Helmet Installation

Helmet  
Installation

Using the  
Glued Surface  
Mounting  
Adapter

Switching the  
Microphone

Earbuds

External  
Mesh  
Intercom  
Antenna

To securely install the headset on the helmet, please follow this procedure.

1. Insert the back plate of the clamp unit between the internal padding and the external shell of the helmet, and tighten the two screws.

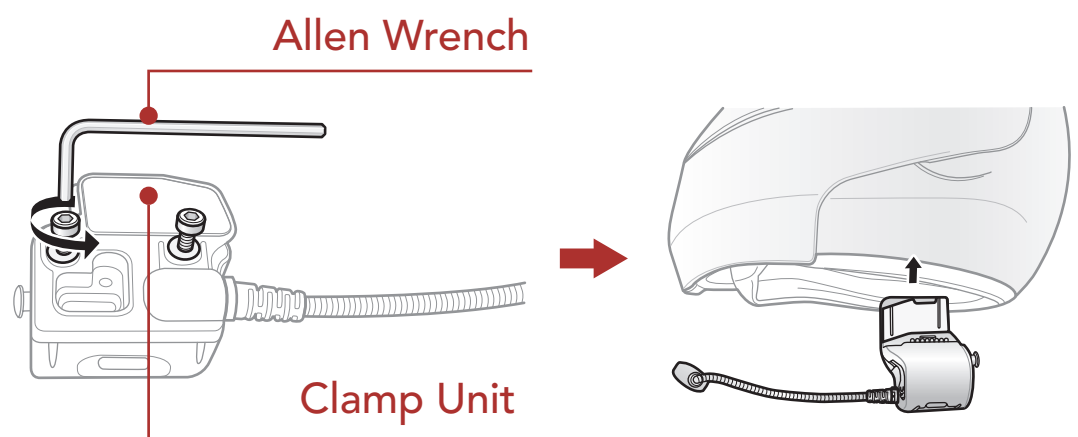

**Note:** Depending on the size and shape of your helmet, you may need to change the thickness of the rubber pad between the clamp plates using the two extra rubber pads in the box. To increase the overall thickness, attach the thinner one to the original rubber pad or replace the original rubber pad with the thicker one.

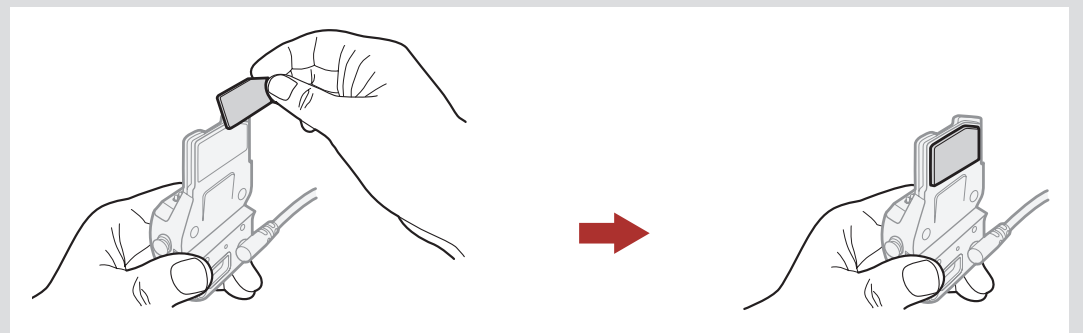



## 2. INSTALLING THE HEADSET ON YOUR HELMET

- Place the helmet speakers along with the hook and loop fasteners, centered to your ear, in the ear pockets of the helmet. If the helmet has deep ear pockets, you can use the speaker pads to place the speakers closer to your ears.

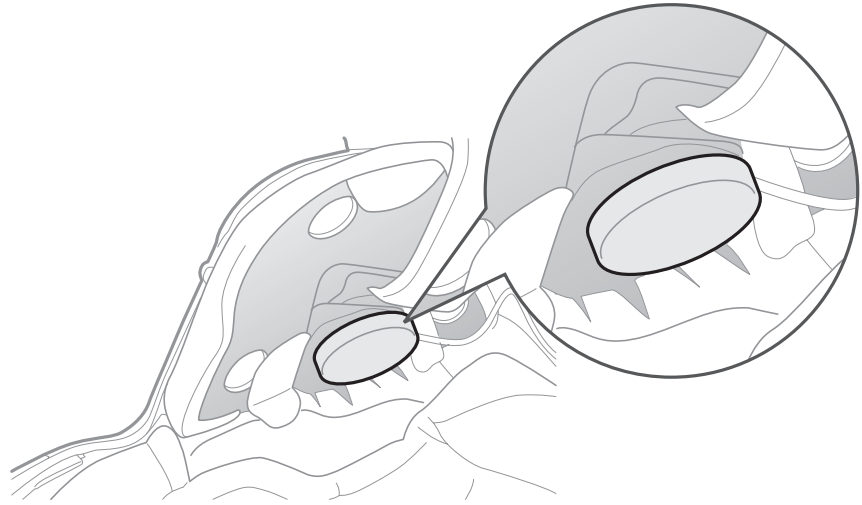

### Note:

- The speaker with the shorter wire is for the left ear and the speaker with the longer one is for the right ear.
- Make sure that the microphone is located properly close to your mouth when you wear the helmet. Adjust the direction of the microphone so that the fin side of the microphone is facing outward, away from your lips.

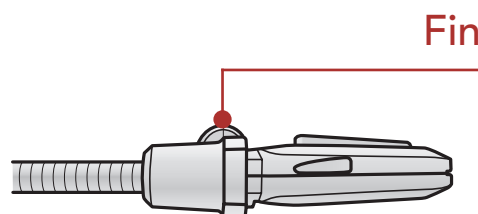

Helmet  
Installation

Using the  
Glued Surface  
Mounting  
Adapter

Switching the  
Microphone

Earbuds

External  
Mesh  
Intercom  
Antenna



## 2. INSTALLING THE HEADSET ON YOUR HELMET

3. Attach the headset main unit to the clamp unit. Slide the main unit down onto the clamp unit until it clicks firmly into the bottom portion of the clamp unit.

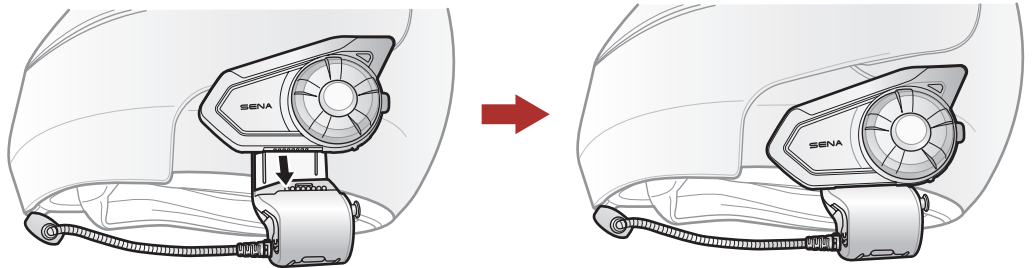

4. To remove the main unit from the clamp unit, press the Quick Release Button to slide it off the clamp unit.

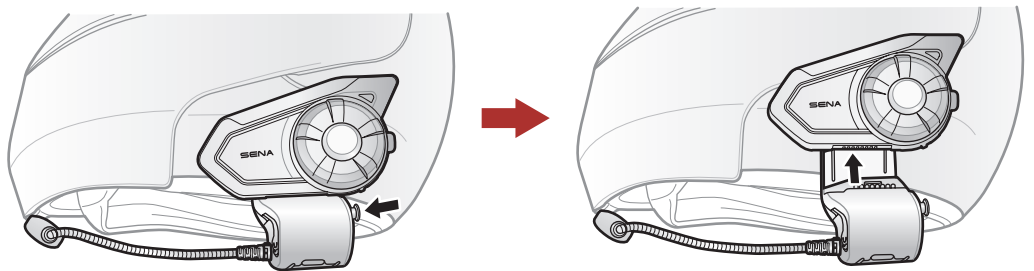

**Helmet  
Installation**

**Using the  
Glued Surface  
Mounting  
Adapter**

**Switching the  
Microphone**

**Earbuds**

**External  
Mesh  
Intercom  
Antenna**



## 2. INSTALLING THE HEADSET ON YOUR HELMET

### 2.2 Using the Glued Surface Mounting Adapter

Helmet  
Installation

Using the  
Glued Surface  
Mounting  
Adapter

Switching the  
Microphone

Earbuds

External  
Mesh  
Intercom  
Antenna

If you have any problem equipping the clamp unit on the helmet for any reason, you may use the glued surface mounting adapter to attach the clamp unit on the external surface of the helmet.

1. Remove the speaker unit.

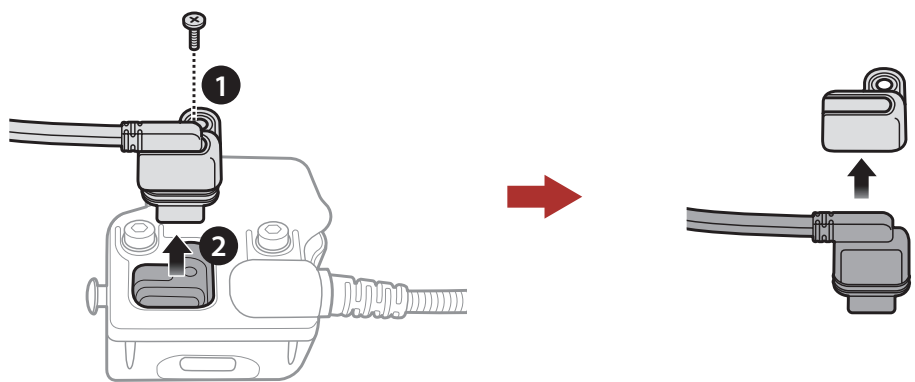

2. Remove the back plate.

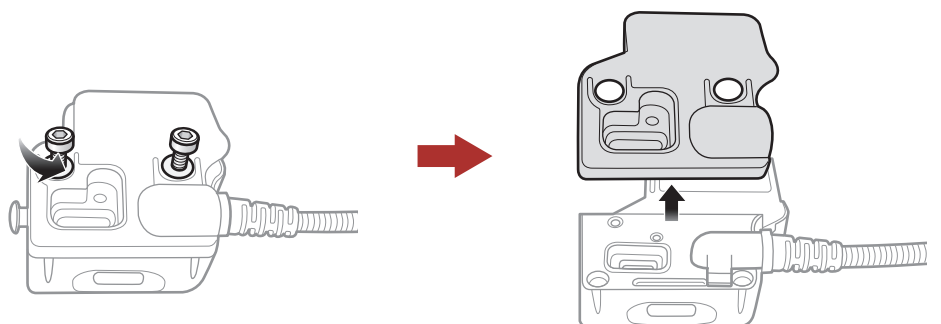

3. Remove the rubber pad and replace it with the thicker rubber pad included in the package.

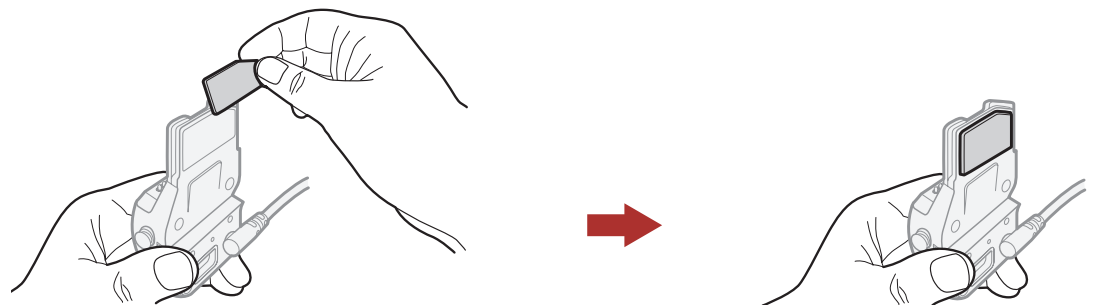

4. Hook on the adapter to the clamp unit then screw in the glued external adapter to the clamp unit.



## 2. INSTALLING THE HEADSET ON YOUR HELMET

5. Reconnect the speaker cable to the speaker port.

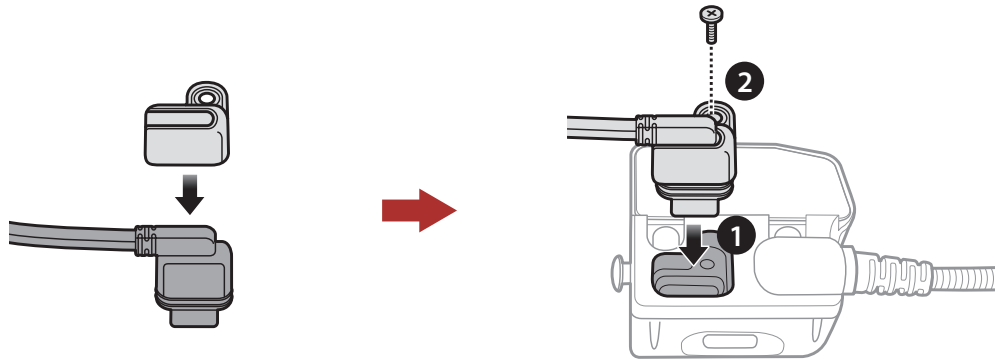

6. Locate a proper surface on the helmet to attach the unit then clean the helmet surface location with a moistened towel and allow it to dry thoroughly.
7. Peel off the cover of the adhesive tape of the adapter and attach the unit on the proper surface of your helmet.

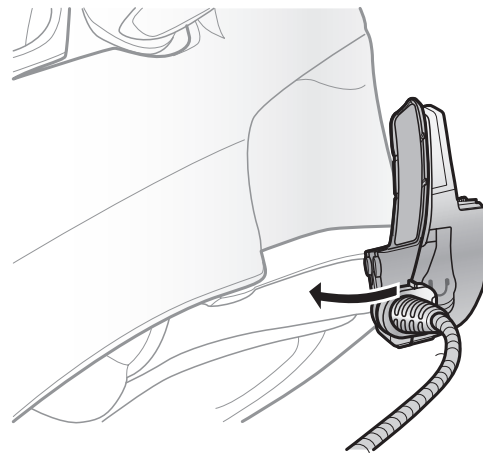

Helmet  
Installation

Using the  
Glued Surface  
Mounting  
Adapter

Switching the  
Microphone

Earbuds

External  
Mesh  
Intercom  
Antenna



## 2. INSTALLING THE HEADSET ON YOUR HELMET

### 2.3 Switching the Microphone

If you want to use a different microphone instead of the static boom microphone, please refer to the following steps.

1. Remove the back plate of the clamp unit.
2. Connect the microphone according to your helmet type.
3. Lock the microphone to the clamp.
4. Reattach the back plate to cover the microphone and the speaker port.

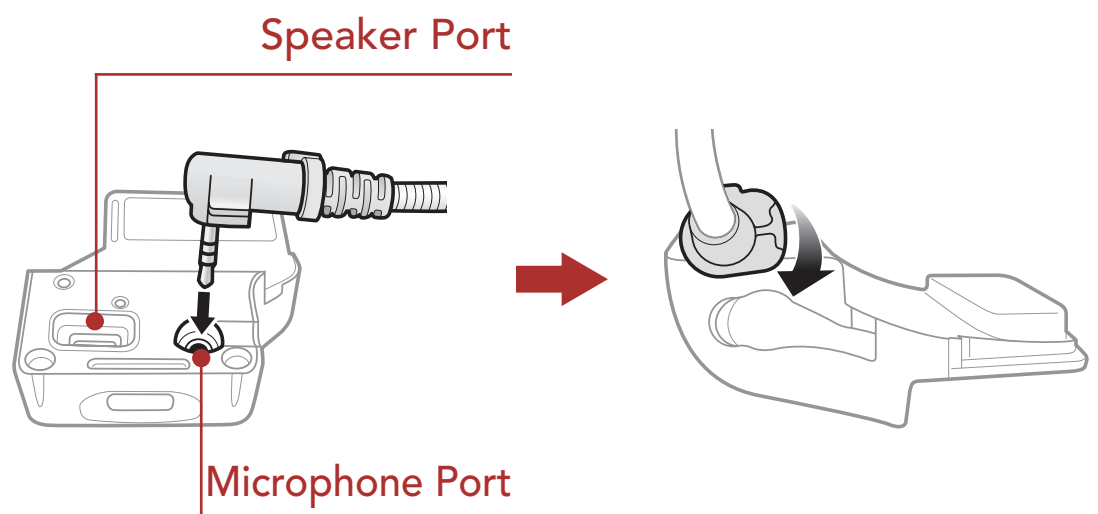

Helmet  
Installation

Using the  
Glued Surface  
Mounting  
Adapter

Switching the  
Microphone

Earbuds

External  
Mesh  
Intercom  
Antenna



## 2. INSTALLING THE HEADSET ON YOUR HELMET

### 2.3.1 Wired Boom Microphone

Helmet  
Installation

Using the  
Glued Surface  
Mounting  
Adapter

Switching the  
Microphone

Earbuds

External  
Mesh  
Intercom  
Antenna

When installing the included wired boom microphone, place the hook and loop fastener at the end of the boom microphone between the internal helmet cheek pad and the internal wall of the helmet shell. The boom microphone should be mounted so it is facing close to your mouth when you wear the helmet.

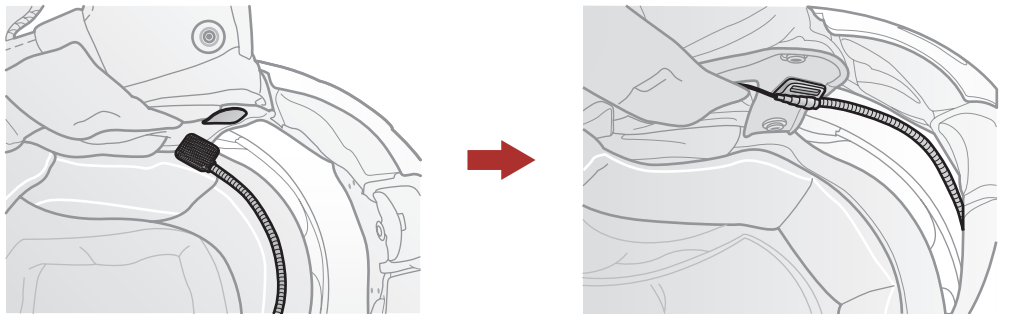

### 2.3.2 Wired Microphone

In case of the wired microphone, attach the enclosed hook and loop fastener for the wired microphone to the inside of the chin guard for full-face helmets. Place the wired microphone on the hook and loop fastener and connect it to the connector of the clamp unit.

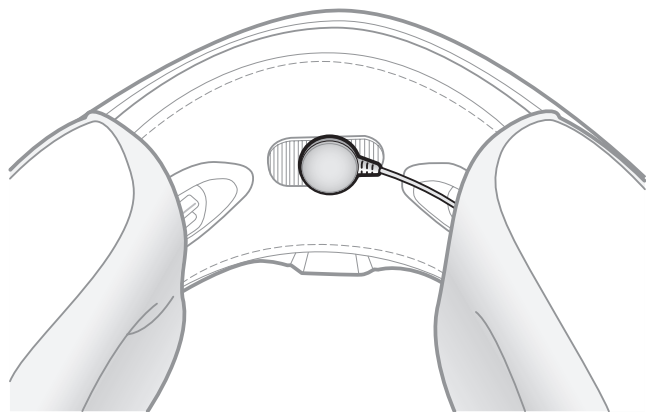





## 2. INSTALLING THE HEADSET ON YOUR HELMET

### 2.4 Earbuds

You can connect your earbuds to the clamp while having the speakers connected to the clamp. The sound of the earbuds will be active while the sound of the outer speakers becomes inactive.

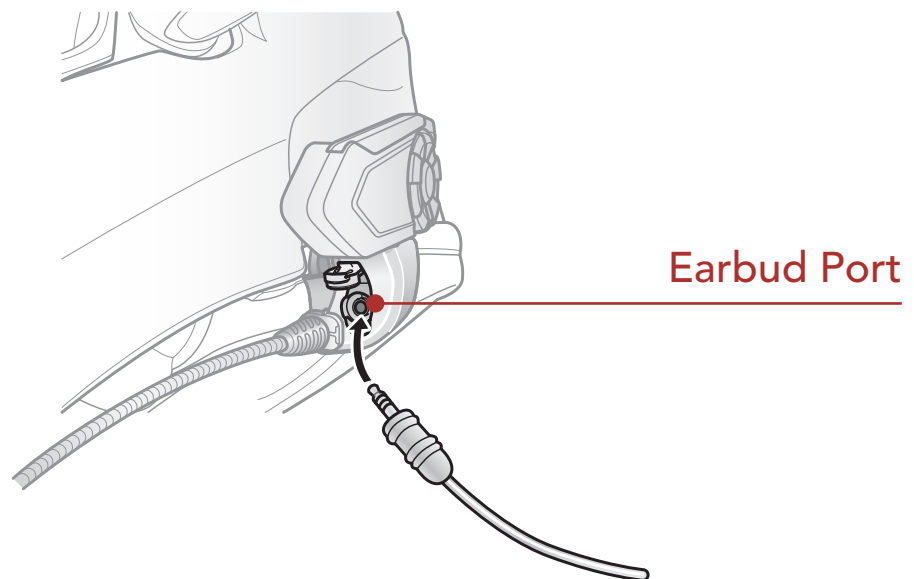

Helmet  
Installation

Using the  
Glued Surface  
Mounting  
Adapter

Switching the  
Microphone

Earbuds

External  
Mesh  
Intercom  
Antenna

### 2.5 External Mesh Intercom Antenna

Pull the **Mesh Intercom** Antenna outwards slightly to unfold it.

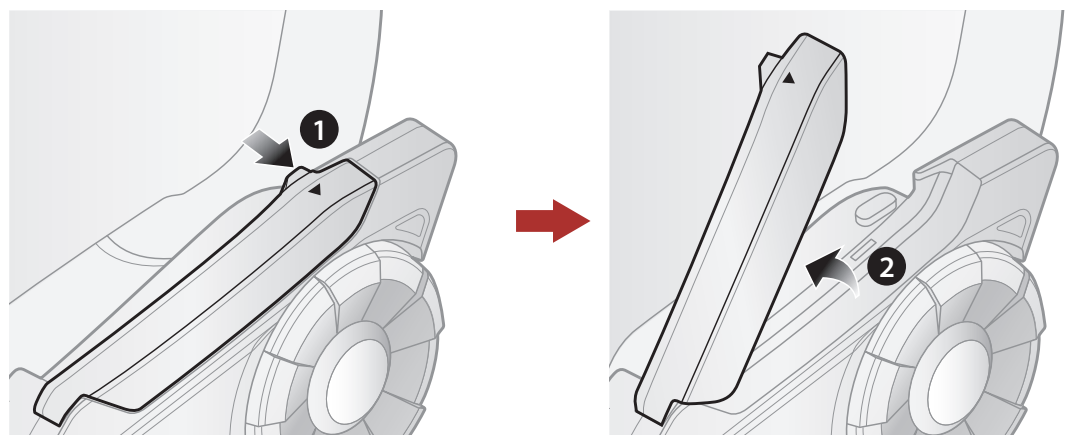



## 3. GETTING STARTED

### 3.1 Button Functions

#### Button Functions

#### Downloadable Sena Software

#### Legend

#### Powering On and Off

#### Charging

#### Checking the Battery Level

#### Volume Adjustment

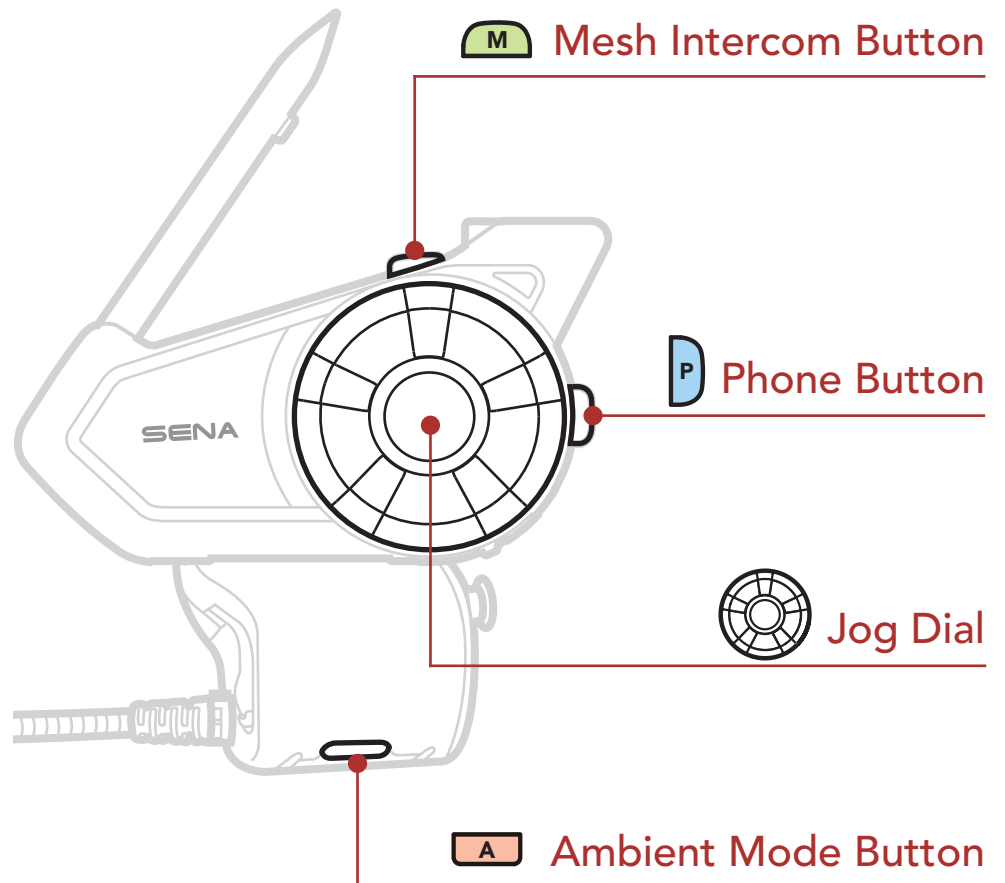

### 3.2 Downloadable Sena Software

#### 3.2.1 Sena Motorcycles App

By simply pairing your phone with your headset, you can use the **Sena Motorcycles App** for quicker, easier set up and management.



#### Sena Motorcycles

- Device configuration setting

- Download the **Sena Motorcycles App** on **Google Play Store** or **App Store**.



## 3. GETTING STARTED

### 3.2.2 Sena Device Manager

The **Sena Device Manager** allows you to upgrade the firmware and configure its settings directly from your PC or Apple computer. Download the **Sena Device Manager** from [sena.com](http://sena.com).

Button Functions

Downloadable Sena Software

Legend

Powering On and Off

Charging

Checking the Battery Level

Volume Adjustment

#### NOTICE

- This **User Guide (Version 4.0.0 or higher)** explains how to operate the 30K with **firmware version 4.0.0 or higher**.
- For operating the 30K with **a firmware version lower than 4.0.0**, refer to the **30K User Guide** that is available when you connect the 30K to the **Sena Motorcycles App**.

### 3.3 Legend



**Tap** Button/Jog Dial the specified number of times



**Press and Hold** Button/Jog Dial for the specified amount of time

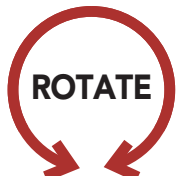

**Rotate** Jog Dial clockwise (right) or counterclockwise (left).



**Rotate while Pressing** Jog Dial clockwise (right) or counterclockwise (left).



"Hello"

**Audible prompt** from the headset



### 3. GETTING STARTED

#### 3.4 Powering On and Off

Press and hold the **Jog Dial** and the **Phone Button** at the same time to turn the headset on or off.

Button Functions

Downloadable Sena Software

Legend

Powering On and Off

Charging

Checking the Battery Level

Volume Adjustment

##### Powering On

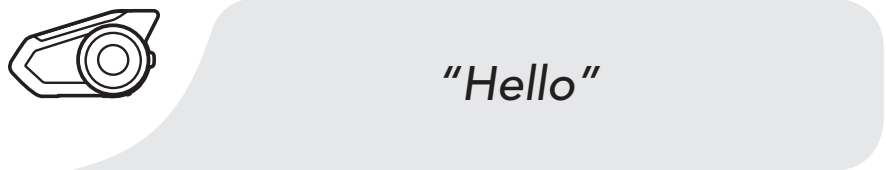

##### Powering Off





## 3. GETTING STARTED

### 3.5 Charging

#### Charging the Headset



DC Power Charging &  
Firmware Upgrade Port

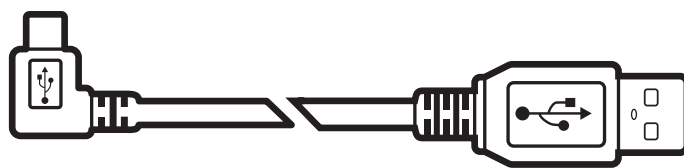

Button  
Functions

Downloadable  
Sena Software

Legend

Powering On  
and Off

Charging

Checking the  
Battery Level

Volume  
Adjustment

The headset will be fully charged in about 2.5 hours. (The charging time may vary depending on the charging method.)

#### Note:

- The headset includes a **Fast Charging** feature which allows it to charge quickly over a short period of time. For example, a user can get up to 2.0 hours of Mesh communication or 2.0 hours of Bluetooth intercom after charging the headset for 20 minutes.
- Any 3rd party USB charger can be used with Sena products if the charger is approved by either the FCC, CE, IC, or other locally approved agencies.
- Use of a non-approved charger may cause fire, explosion, leakage, and other hazards which may also reduce the life time or performance of the battery.



### 3. GETTING STARTED

#### 3.6 Checking the Battery Level

Instruction is for when powering the headset on.

##### Visual Method

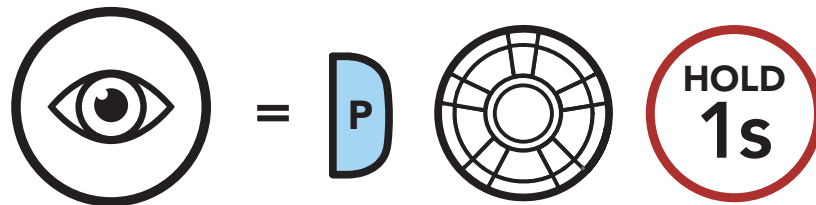

VISUAL METHOD

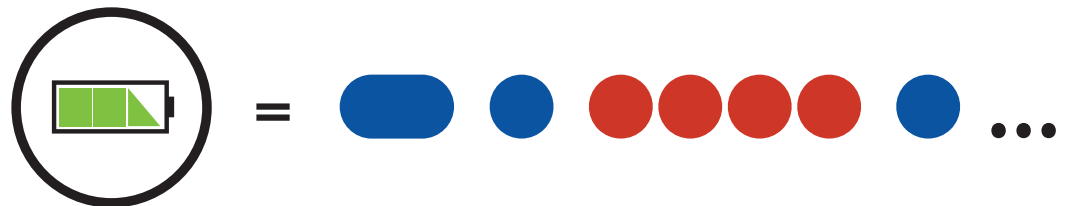

HIGH

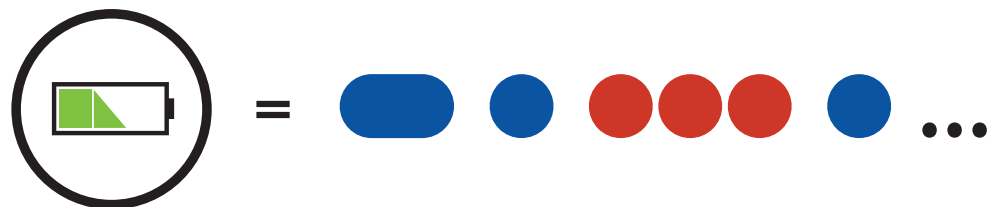

MEDIUM

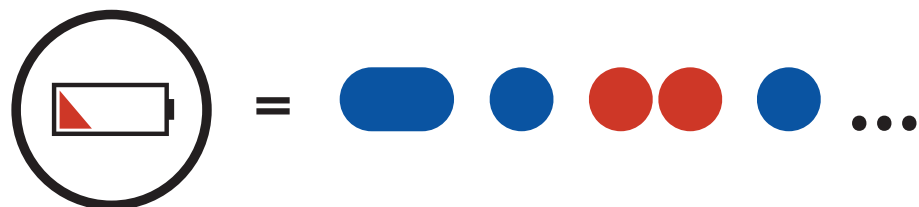

LOW

Button Functions

Downloadable Sena Software

Legend

Powering On and Off

Charging

Checking the Battery Level

Volume Adjustment



## 3. GETTING STARTED

### 3.7 Volume Adjustment

You can raise or lower the volume by rotating the **Jog Dial** clockwise or counterclockwise. Volume is set and maintained independently at different levels for each audio source (i.e., phone, intercom), even when the headset is rebooted.

#### Button Functions

#### Downloadable Sena Software

#### Legend

#### Powering On and Off

#### Charging

#### Checking the Battery Level

#### Volume Adjustment

#### Volume Up

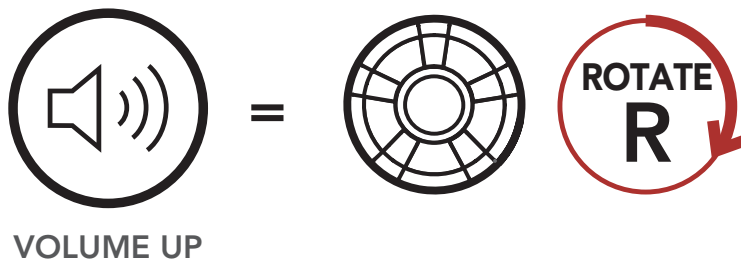

VOLUME UP

#### Volume Down

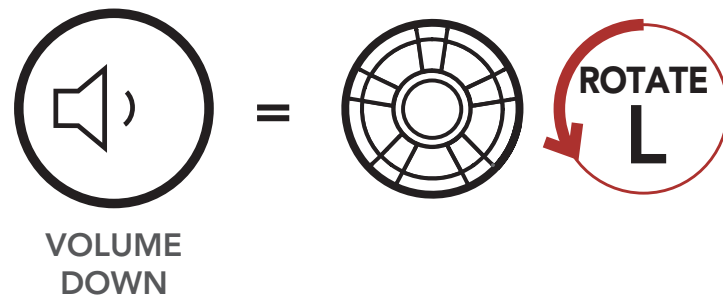

VOLUME DOWN

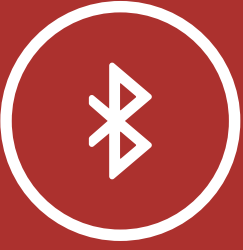

# 4. PAIRING THE HEADSET WITH OTHER BLUETOOTH DEVICES

Phone Pairing

Second Mobile Phone Pairing

Advanced Selective Pairing: Hands-Free or A2DP Stereo

GPS Pairing

When using the headset with other Bluetooth devices for the first time, they'll need to be "paired." This enables them to recognize and communicate with one another whenever they're within range.

The headset can pair with multiple Bluetooth devices such as a mobile phone or GPS via **Mobile Phone Pairing, Second Mobile Phone Pairing** and **GPS Pairing**. The headset can also be paired with up to three other Sena headsets.

Pairs with up to three Sena Headsets

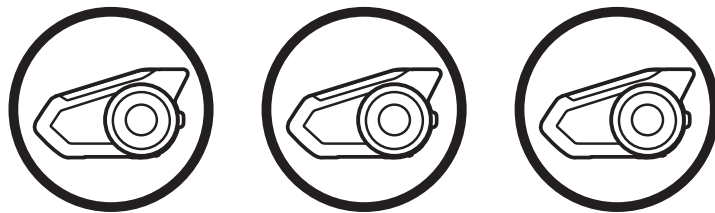

## 4.1 Phone Pairing

There are three ways to pair the phone.

### 4.1.1 Initially Pairing the 30K

The headset will automatically enter the phone pairing mode when you initially turn on the headset or in the following situation:

- Rebooting after executing **Factory Reset**;
- or
- Rebooting after executing **Delete All Pairings**.

1. Press and hold the **Phone Button** and the **Jog Dial** for **1 second**.

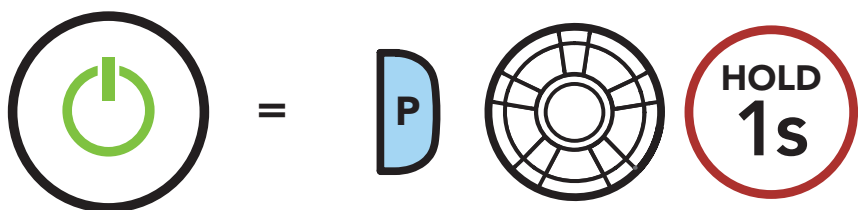

Blinking  



"Phone pairing"



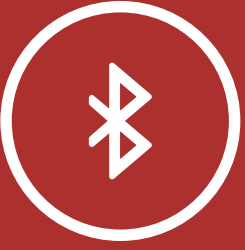

# 4. PAIRING THE HEADSET WITH OTHER BLUETOOTH DEVICES



Phone Pairing

Second Mobile Phone Pairing

Advanced Selective Pairing: Hands-Free or A2DP Stereo

GPS Pairing

2. Select **30K** in the list of Bluetooth devices detected. If your mobile phone asks for a PIN, enter 0000.

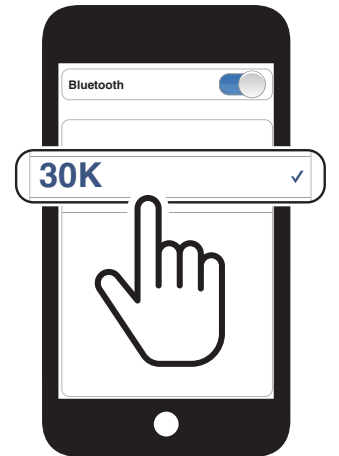

### Note:

- The phone pairing mode lasts for **3 minutes**.
- To cancel phone pairing, tap the **Phone Button** or the **Jog Dial**.

## 4.1.2 Pairing When the 30K is Turned Off

1. While the headset is off, press and hold the **Phone Button** and the **Jog Dial** until the LED flashes red and blue alternately and you hear a voice prompt, **"Phone pairing."**

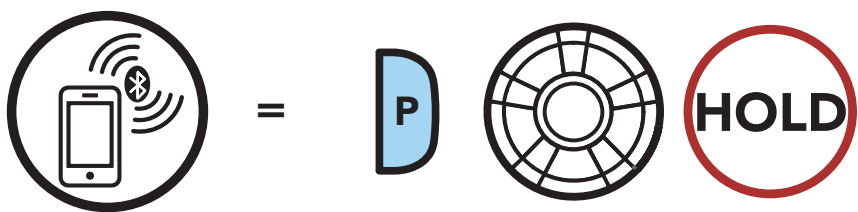

Blinking

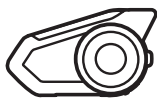

"Phone pairing"

2. Select **30K** in the list of Bluetooth devices detected. If your mobile phone asks for a PIN, enter 0000.

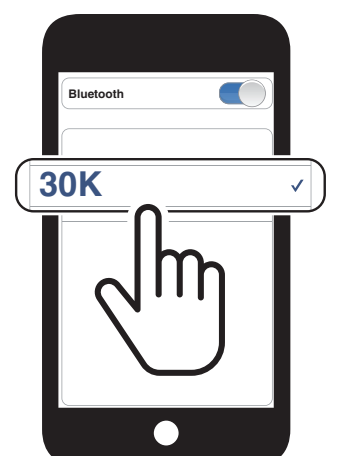

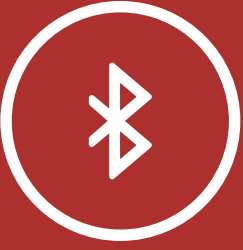

# 4. PAIRING THE HEADSET WITH OTHER BLUETOOTH DEVICES

## 4.1.3 Pairing When the 30K is Turned On

Phone Pairing

Second Mobile Phone Pairing

Advanced Selective Pairing: Hands-Free or A2DP Stereo

GPS Pairing

1. While the headset is on, press and hold the **Phone Button** for **5 seconds**.

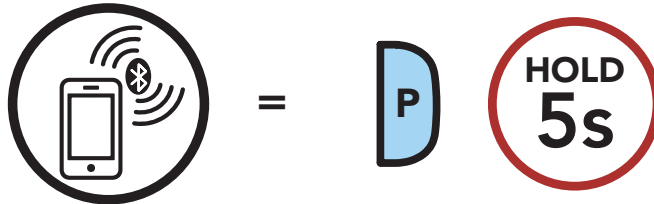

Blinking 

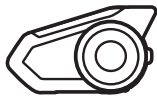

*"Phone pairing"*

2. Select **30K** in the list of Bluetooth devices detected. If your mobile phone asks for a PIN, enter 0000.

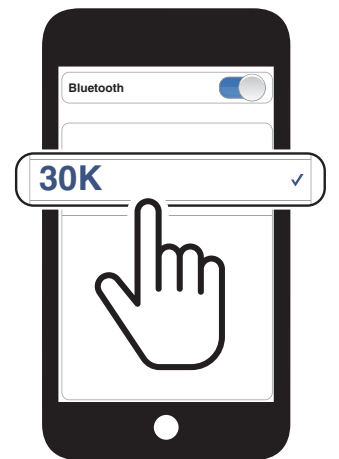

## 4.2 Second Mobile Phone Pairing

1. Press and hold the **Jog Dial** for **5 seconds**.



Blinking 



*"Intercom pairing"*

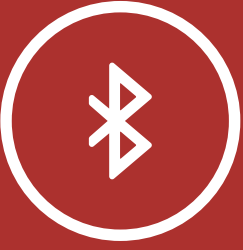

# 4. PAIRING THE HEADSET WITH OTHER BLUETOOTH DEVICES

Phone Pairing

Second Mobile Phone Pairing

Advanced Selective Pairing: Hands-Free or A2DP Stereo

GPS Pairing

2. Tap the **Phone Button**.

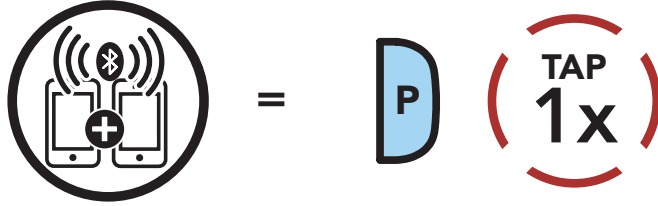

Blinking 

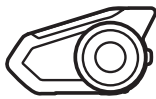

*"Second mobile phone pairing"*

3. Select **30K** in the list of Bluetooth devices detected. If your Bluetooth device asks for a PIN, enter 0000.

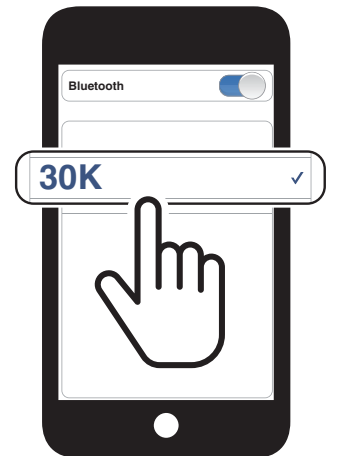

## 4.3 Advanced Selective Pairing: Hands-Free or A2DP Stereo

**Phone Pairing** allows the headset to establish two Bluetooth profiles: **Hands-Free** or **A2DP Stereo**. **Advanced Selective Pairing** allows the headset to separate the profiles to enable connection with two devices.

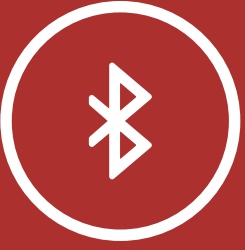

# 4. PAIRING THE HEADSET WITH OTHER BLUETOOTH DEVICES

Phone Pairing

Second Mobile Phone Pairing

Advanced Selective Pairing: Hands-Free or A2DP Stereo

GPS Pairing

## 4.3.1 Phone Selective Pairing - Hands-Free Profile

1. Press and hold the **Phone Button** for **5 seconds**.

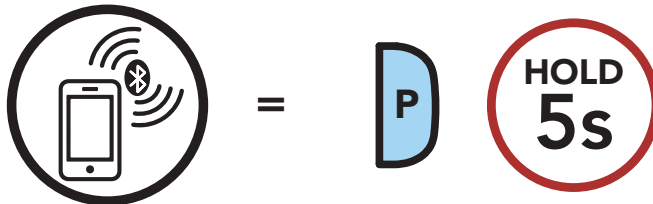

Blinking

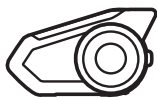

"Phone pairing"

2. Tap the **Phone Button**.

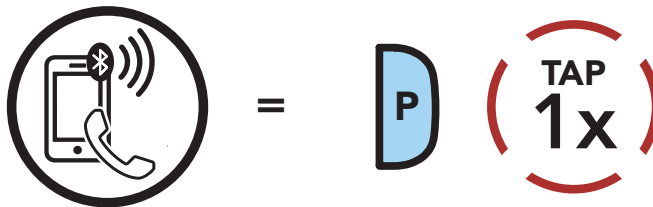

Blinking

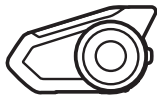

"Phone selective pairing"

3. Select **30K** in the list of Bluetooth devices detected. If your mobile phone asks for a PIN, enter 0000.

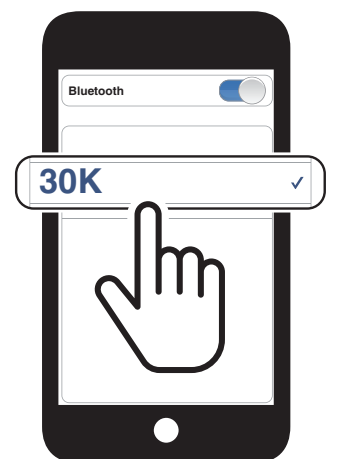



# 4. PAIRING THE HEADSET WITH OTHER BLUETOOTH DEVICES

## 4.3.2 Media Selective Pairing - A2DP Profile

Phone Pairing

Second Mobile Phone Pairing

Advanced Selective Pairing: Hands-Free or A2DP Stereo

GPS Pairing

1. Press and hold the **Phone Button** for **5 seconds**.

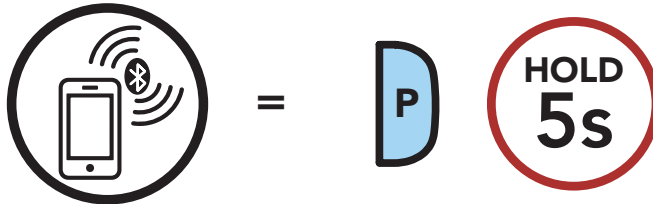

Blinking 

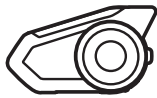

*"Phone pairing"*

2. Tap the **Jog Dial**.

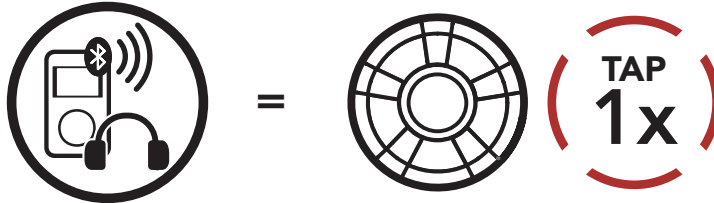

Blinking 



*"Media selective pairing"*

3. Select **30K** in the list of Bluetooth devices detected. If your mobile phone asks for a PIN, enter 0000.

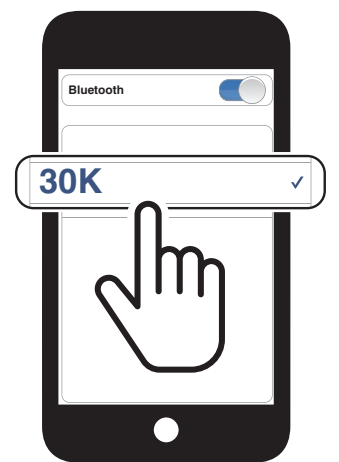

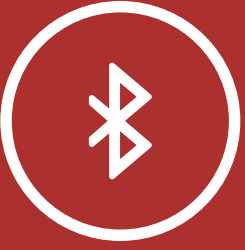

# 4. PAIRING THE HEADSET WITH OTHER BLUETOOTH DEVICES

## 4.4 GPS Pairing

Phone Pairing

Second Mobile Phone Pairing

Advanced Selective Pairing: Hands-Free or A2DP Stereo

GPS Pairing

1. Press and hold the **Jog Dial** for **5 seconds**.



Blinking 

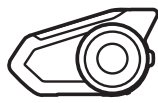

*"Intercom pairing"*

2. Tap the **Phone Button**.

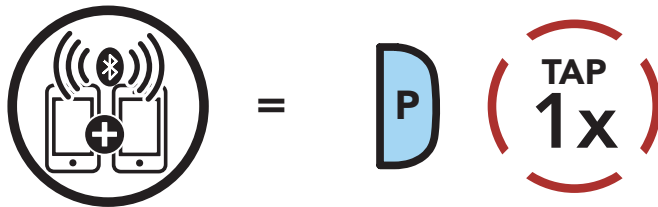

Blinking 

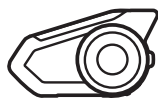

*"Second mobile phone pairing"*

3. Tap the **Phone Button**.

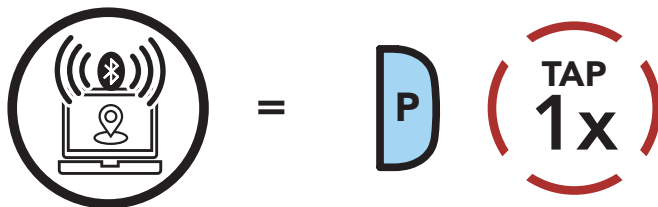

Blinking 

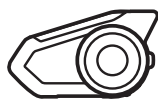

*"GPS pairing"*

4. Select **30K** in the list of devices detected. If your Bluetooth device asks for a PIN, enter 0000.





## 5. MOBILE PHONE USAGE

### 5.1 Making and Answering Calls

Making and Answering Calls

Speed Dialing

Answer a Call

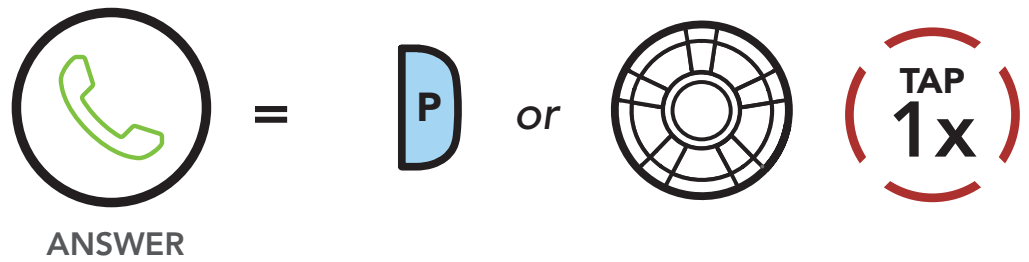

End a Call

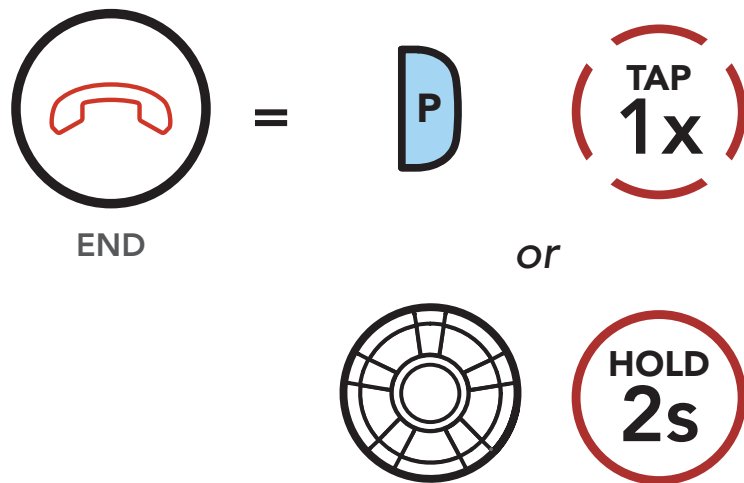

Reject a Call

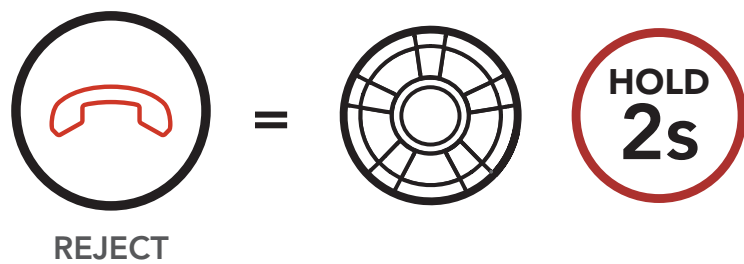

Call a Voice Assistant

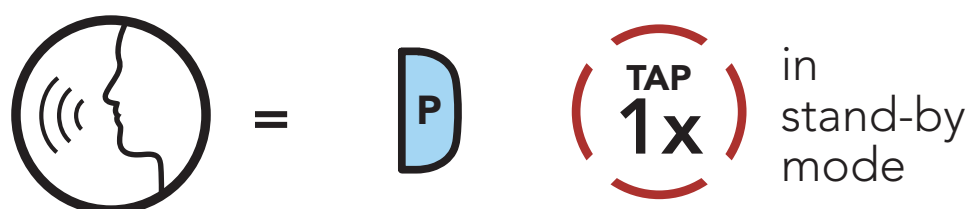



## 5. MOBILE PHONE USAGE

### 5.2 Speed Dialing

Making and Answering Calls

Speed Dialing

#### 5.2.1 Assigning Speed Dial Presets

**Speed Dial Presets could be assigned** in the settings menu, accessible through **Sena Device Manager** or **Sena Motorcycles App**.

#### 5.2.2 Using Speed Dial Presets

1. Tap the **Phone Button** twice to enter into the **Speed Dial** menu. You will hear the voice prompt, **"Speed dial."**

##### Enter Speed Dial Mode

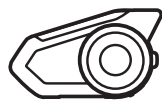
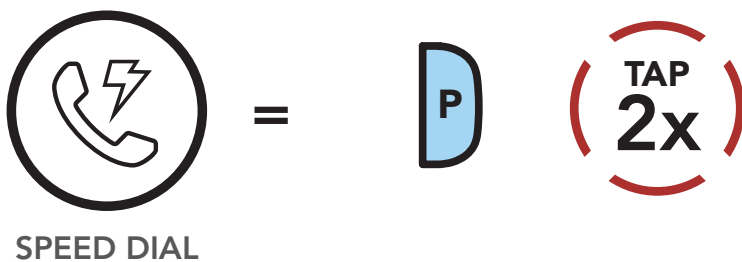

*"Speed dial"*

2. Rotate the **Jog Dial** clockwise or counterclockwise to navigate between the **Speed Dial Presets**.

##### Navigate Forward through Speed Dial Preset Numbers

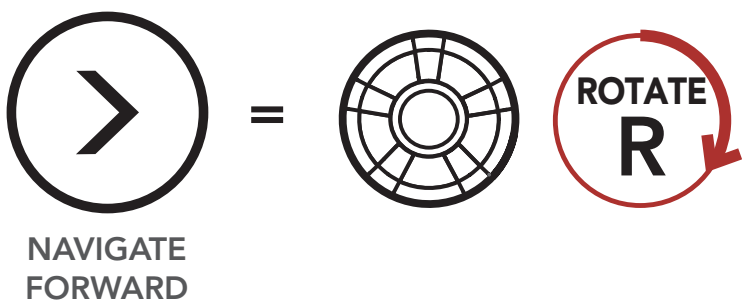

##### Navigate Backward through Speed Dial Preset Numbers

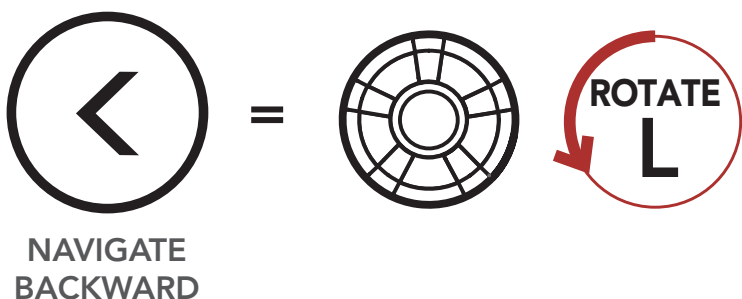





## 5. MOBILE PHONE USAGE

### Making and Answering Calls

#### Speed Dialing

- To call one of your **Speed Dial Presets**, tap the **Phone Button** when you hear the prompt, **"Speed dial (#)."**

#### Call a Speed Dial Preset Number

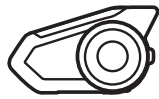
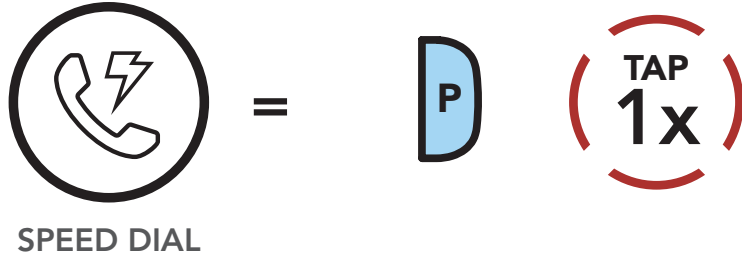

*"Speed dial (#)"*

- To redial the last number called, tap the **Phone Button** when you hear the prompt, **"Last number redial."**

#### Redial Last Number

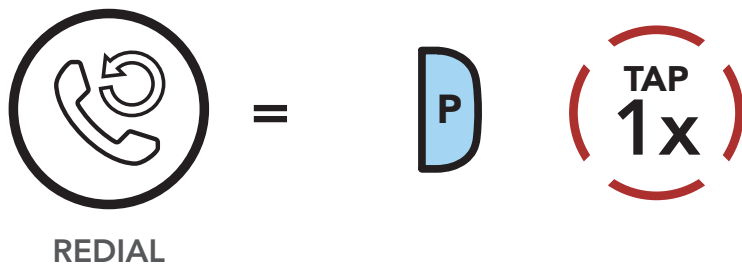

*"Last number redial"*



## 6. STEREO MUSIC

### 6.1 Playing Music with Bluetooth Devices

Playing  
Music with  
Bluetooth  
Devices

Music Sharing

- To play or pause music, press and hold the **Jog Dial** for **1 second** until you hear a double beep.

Play/Pause

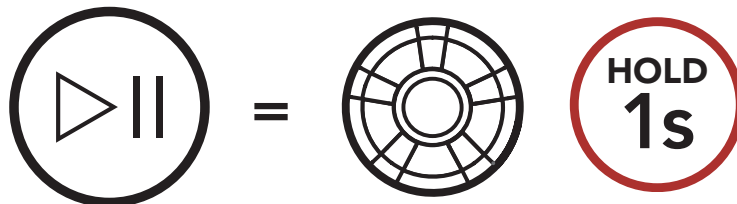

PLAY/PAUSE

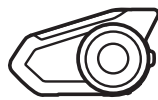

"[Beep, Beep]"

- To adjust the volume, rotate the **Jog Dial** clockwise or counterclockwise.

Volume Up

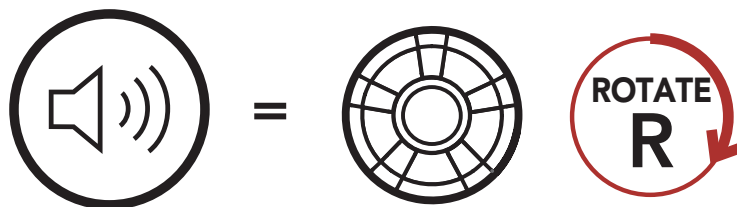

VOLUME  
UP

Volume Down

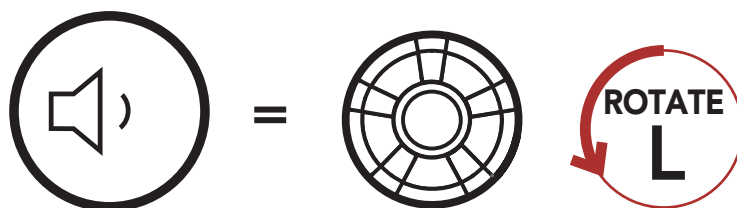

VOLUME  
DOWN



Playing  
Music with  
Bluetooth  
Devices

Music Sharing

## 6. STEREO MUSIC

3. To track forward or back, rotate while pressing the **Jog Dial** clockwise or counterclockwise.

### Track Forward

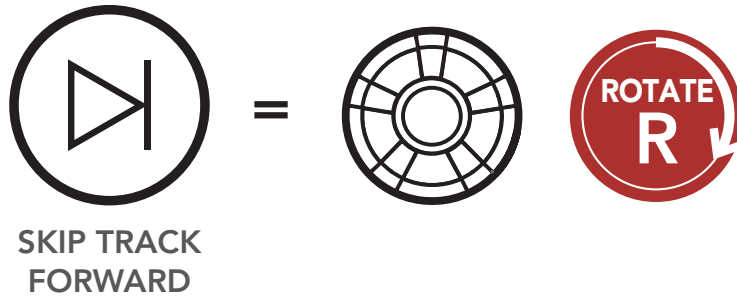

### Track Backward

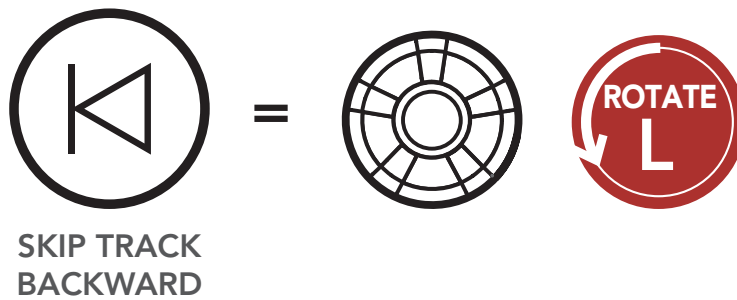

## 6.2 Music Sharing

You can start sharing music with one intercom friend using Bluetooth stereo music during a **two-way intercom conversation** and **one participant of a Mesh**. If you start sharing music while Bluetooth intercom and Mesh Intercom are running at the same time, then music shared during Bluetooth intercom will take priority over music shared during Mesh Intercom.

### Note:

- Both you and your intercom friend can remotely control music playback such as track forward and track back.
- **Music sharing** will be paused when you are using your mobile phone or listening to GPS instructions.
- **Music sharing** will be terminated if the headset starts a multi-way intercom conference.



## 6. STEREO MUSIC

### 6.2.1 Bluetooth Intercom Music Sharing

Playing  
Music with  
Bluetooth  
Devices

Music Sharing

You can start sharing the music with one intercom friend of a **two-way intercom conversation**.

#### Start Sharing Music

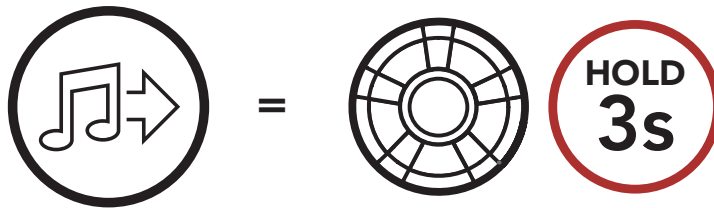

*"Music sharing on"*

#### Terminate Sharing Music

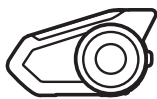
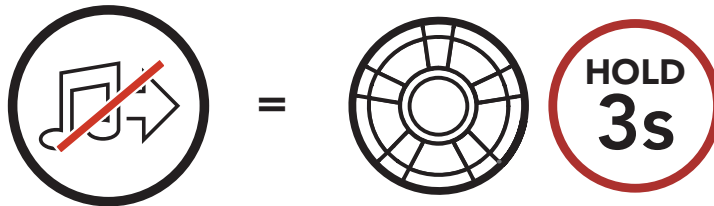

*"Music sharing off"*

### 6.2.2 Mesh Intercom Music Sharing

You can start sharing music with one participant of a **Mesh Intercom**.

#### Start Sharing Music

1. The **Creator** will send a request message to **participants** connected during **Mesh Intercom**.

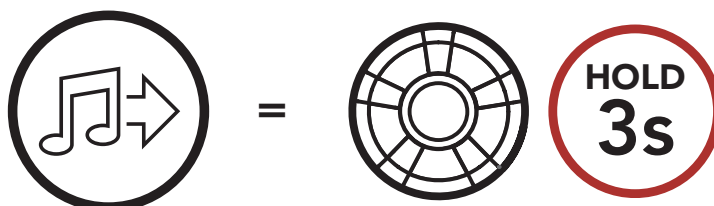



## 6. STEREO MUSIC

Playing Music with Bluetooth Devices

Music Sharing

[Creator]

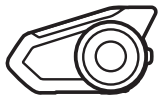

"Music sharing on"

[Participants]

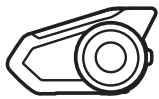

"Would you like to accept music sharing?"

2. The **Creator** will share music with the **first participant** that accepts the request.

[Participant] Accept



=



[Participant] Refuse

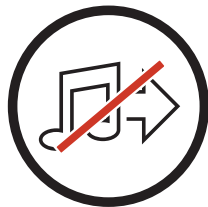

=



Terminate Sharing Music

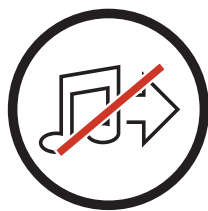

=

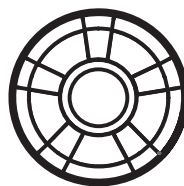

"Music sharing off"

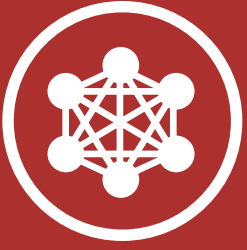

## 7. MESH INTERCOM

### 7.1 What is Mesh Intercom?

What is Mesh Intercom?

Starting Mesh Intercom

Using the Mesh in Open Mesh

Using Mesh in Group Mesh

Enable/Disable Mic

Toggling Open Mesh/Group Mesh

Mesh Reach-Out Request

Reset Mesh

**Mesh Intercom™** is a dynamic communication system created by Sena that provides instant and effortless bike-to-bike communication without a pre-grouping process. **Mesh Intercom** allows users to connect and communicate with nearby users without the need to pair each headset together.

The working distance between each **30K** in **Mesh Intercom** can be up to 2 km (1.2 mi) in open terrain. In open terrain, the **Mesh** can be extended up to 8 km (5 mi) between a minimum of six users.

Users can communicate in two modes:

- Open Mesh™ for open group intercom conversations.
- Group Mesh™ for private group intercom conversations.

**Mesh Intercom**

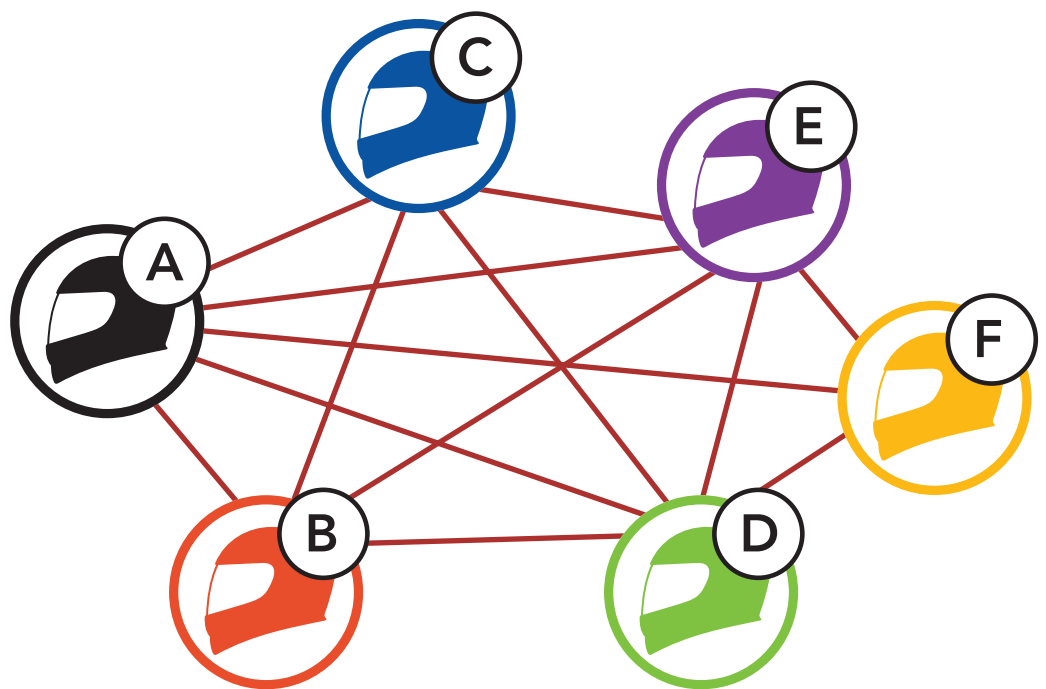



# 7. MESH INTERCOM

## 7.1.1 Open Mesh

What is Mesh Intercom?

Starting Mesh Intercom

Using the Mesh in Open Mesh

Using Mesh in Group Mesh

Enable/Disable Mic

Toggling Open Mesh/Group Mesh

Mesh Reach-Out Request

Reset Mesh

**Open Mesh** is an open group intercom function. Users can freely communicate with each other in the same **Open Mesh** channel and select which channel (1-9) to use through the headset.

It can connect with a virtually unlimited number of users in each channel.

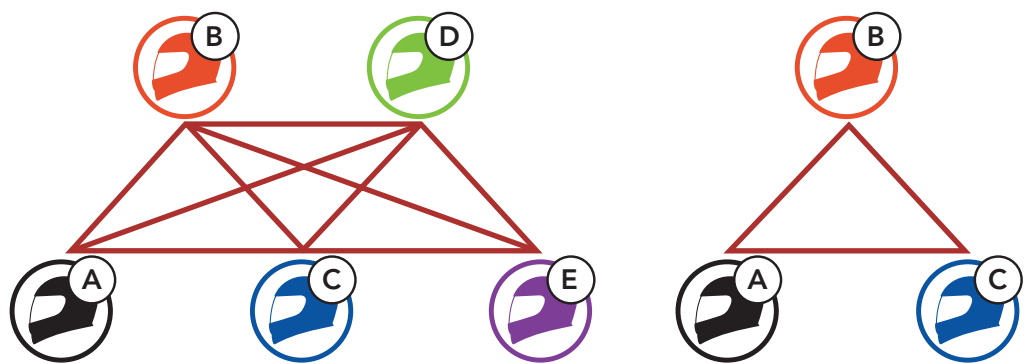
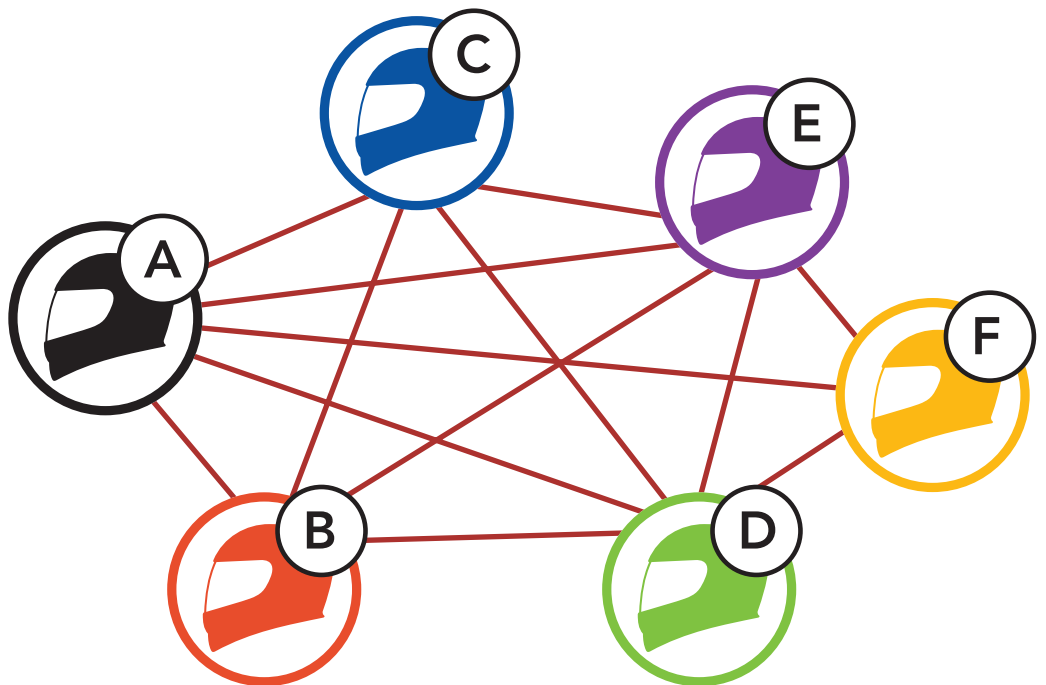

Channel 1

Channel 2

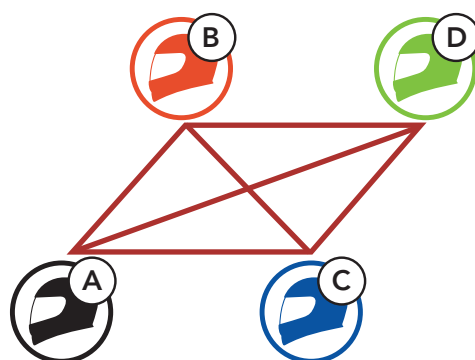

Channel 9



## 7. MESH INTERCOM

### 7.1.2 Group Mesh

What is Mesh Intercom?

Starting Mesh Intercom

Using the Mesh in Open Mesh

Using Mesh in Group Mesh

Enable/Disable Mic

Toggling Open Mesh/Group Mesh

Mesh Reach-Out Request

Reset Mesh

**Group Mesh** is a closed group intercom function that allows users to join, leave, or rejoin a group intercom conversation without pairing each headset. Users can freely communicate with each other in the same private group in **Group Mesh**.

For closed intercom conversations using **Mesh Intercom**, a **Group Mesh** needs to be created by the users. When users create a private group in **Group Mesh** by **Mesh Grouping**, the headset automatically switches from **Open Mesh** to **Group Mesh**. Up to 24 users can all be connected in each private group.

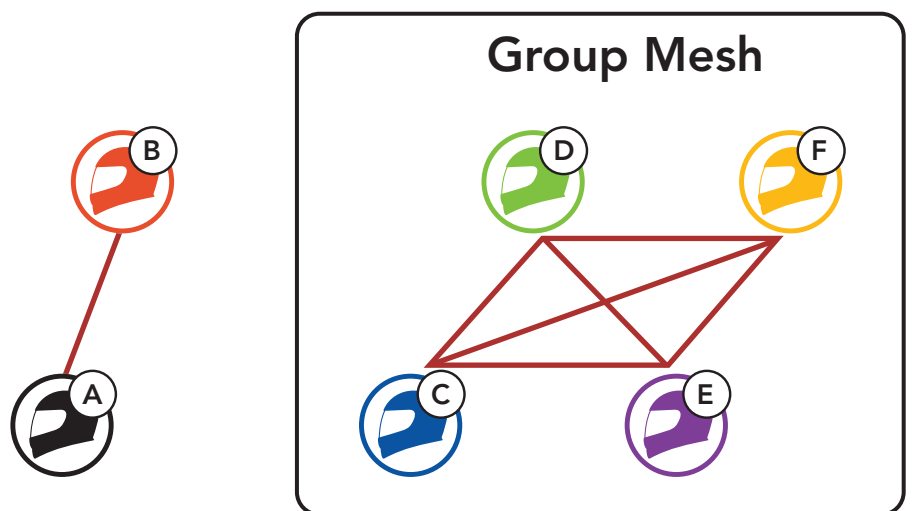





## 7. MESH INTERCOM

### 7.2 Starting Mesh Intercom

When **Mesh Intercom** is enabled, the **30K** will automatically connect to nearby **30K** users and allow them to talk to each other.

#### Mesh Intercom On

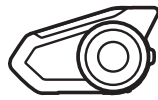
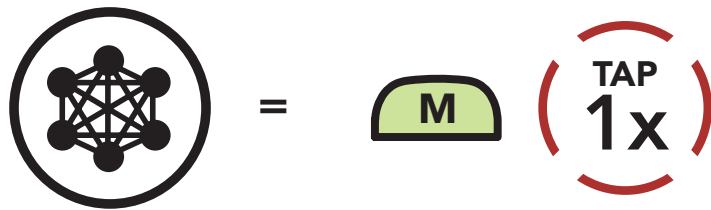

*"Mesh intercom on"*

#### Mesh Intercom Off

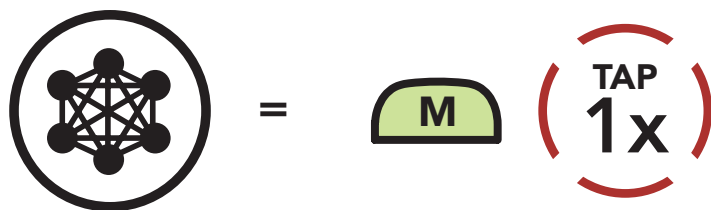

*"Mesh intercom off"*

**Note:** **Open Mesh** and **Group Mesh** cannot communicate with the previous modes **Public Mode** and **Private Mode**. In case of no communication, **the headset should be upgraded to the latest firmware.**

### 7.3 Using the Mesh in Open Mesh

When **Mesh Intercom** is enabled, the headset will be in **Open Mesh (default: channel 1)** initially.

What is Mesh Intercom?

Starting Mesh Intercom

Using the Mesh in Open Mesh

Using Mesh in Group Mesh

Enable/Disable Mic

Toggling Open Mesh/Group Mesh

Mesh Reach-Out Request

Reset Mesh



# 7. MESH INTERCOM

## 7.3.1 Channel Setting (Default: channel 1)

If the **Open Mesh** communication experiences interference because other groups are also using **channel 1 (default)**, change the channel. You can select from channels 1 to 9.

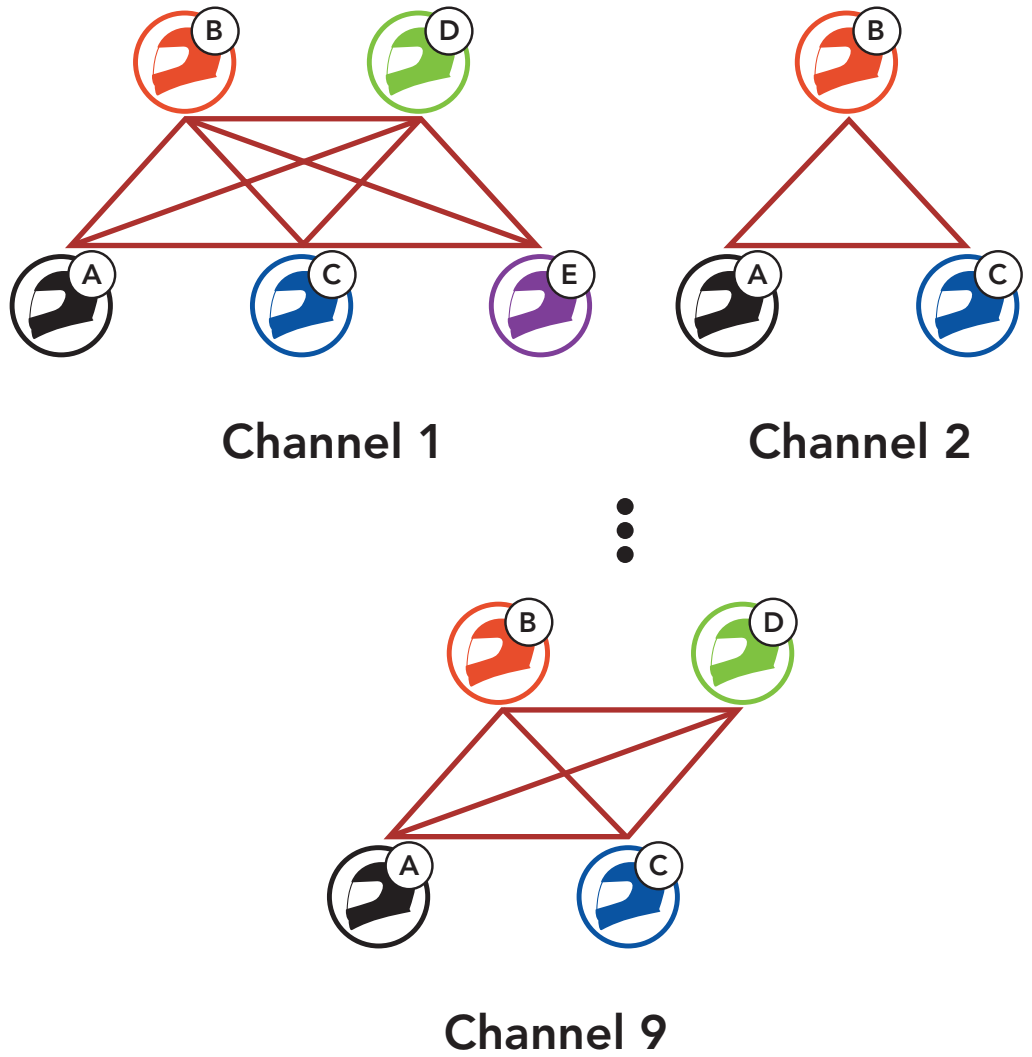

Enter into the Channel Setting

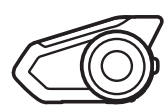
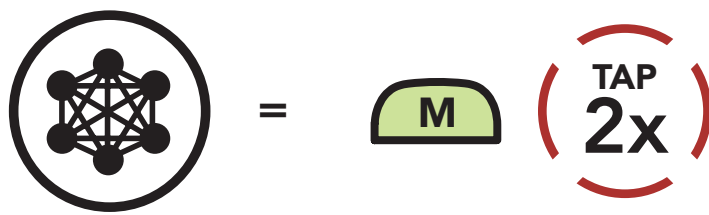

"Channel setting, 1"



What is Mesh Intercom?

Starting Mesh Intercom

Using the Mesh in Open Mesh

Using Mesh in Group Mesh

Enable/Disable Mic

Toggling Open Mesh/Group Mesh

Mesh Reach-Out Request

Reset Mesh



# 7. MESH INTERCOM

## Navigate Between Channels

(1 → 2 → ... → 8 → 9 → Exit → 1 → ...)

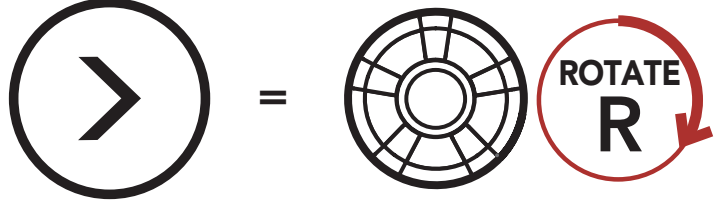

or

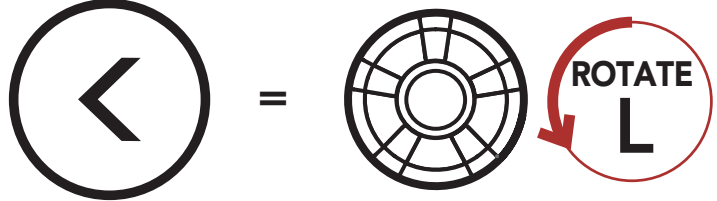

"#"



## Save the Channel

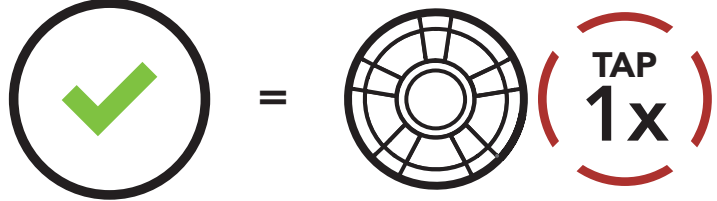

"Channel is set, channel #"

What is Mesh Intercom?

Starting Mesh Intercom

Using the Mesh in Open Mesh

Using Mesh in Group Mesh

Enable/Disable Mic

Toggling Open Mesh/Group Mesh

Mesh Reach-Out Request

Reset Mesh



## 7. MESH INTERCOM

What is Mesh Intercom?

Starting Mesh Intercom

Using the Mesh in Open Mesh

Using Mesh in Group Mesh

Enable/Disable Mic

Toggling Open Mesh/Group Mesh

Mesh Reach-Out Request

Reset Mesh

### Note:

- **Channel Setting** always starts with channel 1.
- If you do not press any button for approximately **10 seconds** in a specific channel, the channel is automatically saved.
- If you want to cancel during **Channel Setting**, tap the **Phone Button**.
- The channel will be remembered even if you turn off the **30K**.
- You can also change the **Channel Setting** of the headset through the **Sena Motorcycles App**.

### 7.4 Using Mesh in Group Mesh

#### 7.4.1 Creating a Group Mesh

Creating a **Group Mesh** requires **two or more Open Mesh users**.

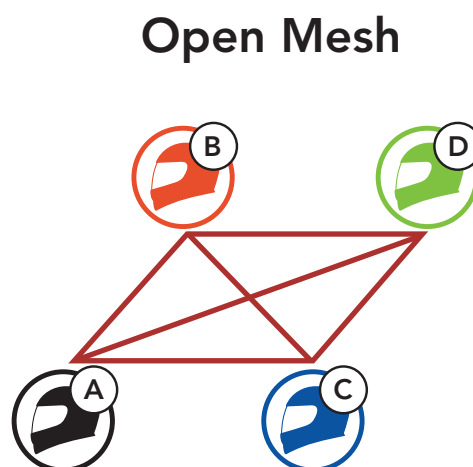



# 7. MESH INTERCOM

1. Enter into **Mesh Grouping** to create a **Group Mesh**.

What is Mesh Intercom?

Starting Mesh Intercom

Using the Mesh in Open Mesh

Using Mesh in Group Mesh

Enable/Disable Mic

Toggling Open Mesh/Group Mesh

Mesh Reach-Out Request

Reset Mesh

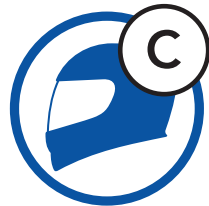

YOU

and

=



FRIEND

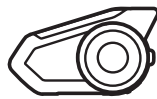

"Mesh grouping"

2. The headsets complete **Mesh Grouping** and automatically switch from **Open Mesh** to **Group Mesh**.

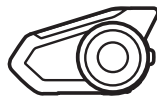

"Group Mesh"

Open Mesh

Group Mesh

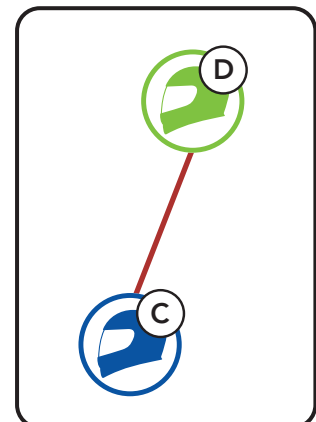



## 7. MESH INTERCOM

What is Mesh Intercom?

Starting Mesh Intercom

Using the Mesh in Open Mesh

Using Mesh in Group Mesh

Enable/Disable Mic

Toggling Open Mesh/Group Mesh

Mesh Reach-Out Request

Reset Mesh

### Note:

- If the **Mesh Grouping** is not completed within **30 seconds**, users will hear a voice prompt, "**Grouping failed.**"
- If you want to cancel during the **Mesh Grouping**, tap the **Mesh Intercom Button** or the **Phone Button**.

### 7.4.2 Joining an Existing Group Mesh

One of the members in an **Existing Group Mesh** can allow new members in **Open Mesh** to join the **Existing Group Mesh**.

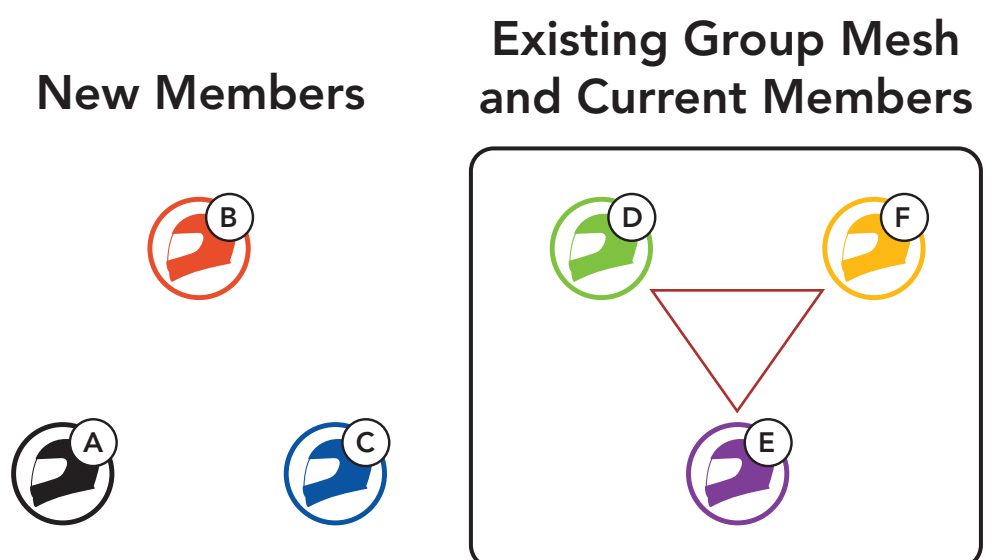



# 7. MESH INTERCOM

What is Mesh Intercom?

Starting Mesh Intercom

Using the Mesh in Open Mesh

Using Mesh in Group Mesh

Enable/Disable Mic

Toggling Open Mesh/Group Mesh

Mesh Reach-Out Request

Reset Mesh

1. One of the current members and a new member enter into Mesh Grouping to join the Existing Group Mesh.



YOU (NEW MEMBER)

and

=



CURRENT MEMBER IN GROUP MESH

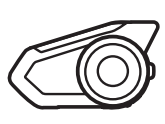

"Mesh grouping"

2. The headsets complete Mesh Grouping. The new members will hear a voice prompt as their headsets automatically switch from Open Mesh to Group Mesh.

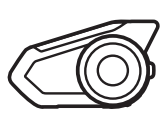

"Group Mesh"

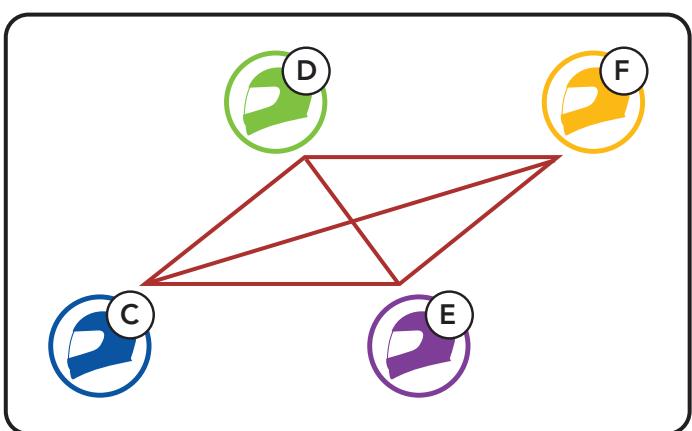



## 7. MESH INTERCOM

What is Mesh Intercom?

Starting Mesh Intercom

Using the Mesh in Open Mesh

Using Mesh in Group Mesh

Enable/Disable Mic

Toggling Open Mesh/Group Mesh

Mesh Reach-Out Request

Reset Mesh

**Note:** If the **Mesh Grouping** is not completed within **30 seconds**, the current members will hear low-toned double beeps and the new member will hear a voice prompt, "**Grouping failed.**"

### 7.5 Enable/Disable Mic (Default: Enable)

Users can enable/disable the microphone when communicating in a **Mesh Intercom**.

**Enable/Disable the Microphone**

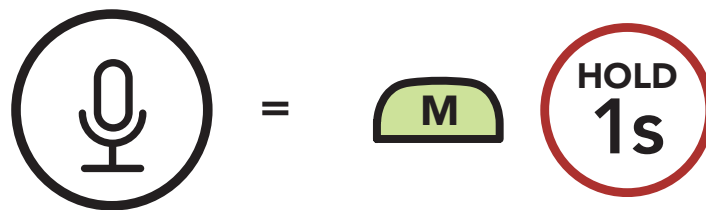

### 7.6 Toggling Open Mesh/Group Mesh

Users are able to toggle between **Open Mesh** and **Group Mesh** without resetting the **Mesh**. This allows users to keep the **Group Mesh Network** connection information while in **Open Mesh**.

Users can toggle to **Group Mesh** to communicate with participants from the stored **Group Mesh Network** connection information.





# 7. MESH INTERCOM

## Toggle Between Open Mesh and Group Mesh

What is Mesh Intercom?

Starting Mesh Intercom

Using the Mesh in Open Mesh

Using Mesh in Group Mesh

Enable/Disable Mic

Toggling Open Mesh/Group Mesh

Mesh Reach-Out Request

Reset Mesh

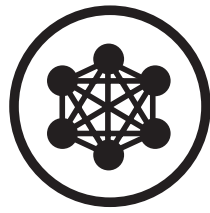

Open Mesh

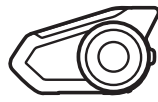

"Open Mesh"



=

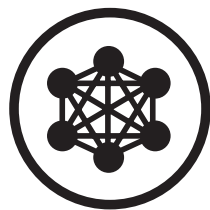

Group Mesh

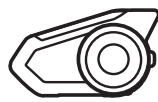

"Group Mesh"

**Note:** If you have never participated in **Group Mesh**, you cannot toggle between **Open Mesh** and **Group Mesh**. You will hear a voice prompt, **"No group available."**

## 7.7 Mesh Reach-Out Request

You (caller) can send a request message to turn on the Mesh Intercom to nearby\* friends who have it turned off.

1. If you want to send or receive a request message, you need to enable **Mesh Reach-Out** on the **Sena Motorcycles App**. Please refer to **Section 12.2: "Software Configuration Setting."**
2. While your headset's Mesh Intercom is on, you (caller) send a request message using the **headset's Button** or the **Sena Motorcycles App**.

[Caller]



=





# 7. MESH INTERCOM



What is Mesh Intercom?

Starting Mesh Intercom

Using the Mesh in Open Mesh

Using Mesh in Group Mesh

Enable/Disable Mic

Toggling Open Mesh/Group Mesh

Mesh Reach-Out Request

Reset Mesh

[Caller]

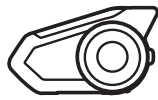

"Mesh reach-out request"

[Nearby Friends]

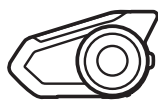

"Mesh intercom requested"

3. Friends who receive the request message need to manually turn on their Mesh Intercom using the **headset's Button** or the **Sena Motorcycles App**.

**Note:**

- \*: Up to 100 m (109 yds) in open terrain
- To use the **Mesh Reach-Out Request** function, **you (caller) who sends a request message and the friends who receive the request message must update the headset to the latest firmware version and the app to the latest version.**

## 7.8 Reset Mesh

If a headset in an **Open Mesh** or **Group Mesh** resets the **Mesh**, it will automatically return to **Open Mesh (default: channel 1)**.

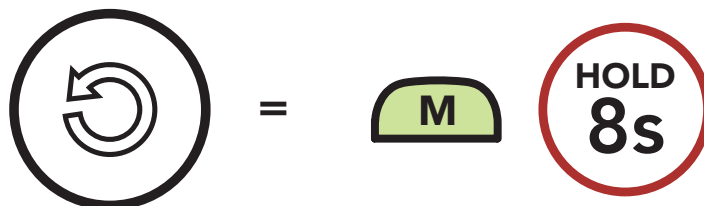



## 8. BLUETOOTH INTERCOM

Up to three people can communicate via intercom with the headset simply by pairing their headsets.

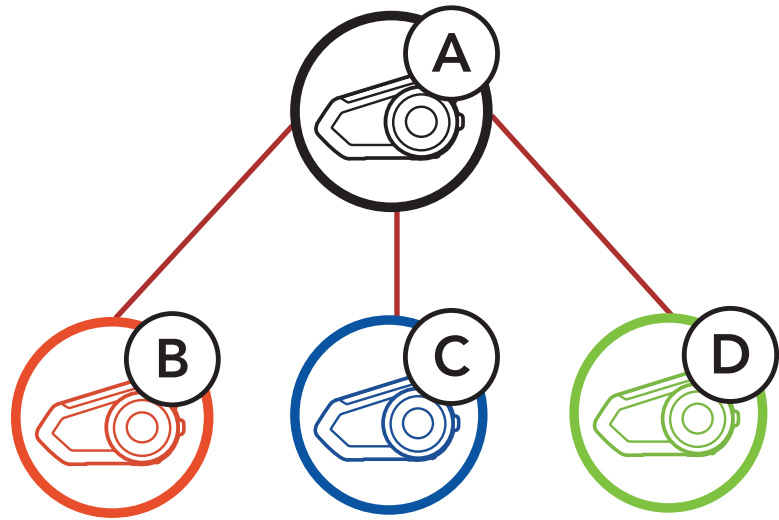

Intercom  
Pairing

Last-Come,  
First-Served

Two-Way  
Intercom

Multi-Way  
Intercom

Three-Way  
Conference  
Phone Call with  
Intercom Users

Group Intercom

Mesh Intercom  
Conference  
with Bluetooth  
Intercom  
Participant



Universal  
Intercom

### 8.1 Intercom Pairing

There are two ways to pair the headset.

#### 8.1.1 Using the Smart Intercom Pairing (SIP)

**SIP** allows you to quickly pair with your friends for intercom communication by scanning the QR code on the **Sena Motorcycles App** without remembering the button operation.

1. Pair the mobile phone with the headset.
2. Open the **Sena Motorcycles App** and tap  (**Smart Intercom Pairing Menu**).
3. Scan the **QR code** displayed on your friend (**B**)'s mobile phone.
  - Your friend (**B**) can display the QR code on the mobile phone by tapping  > **QR code** () on the **Sena Motorcycles App**.



## 8. BLUETOOTH INTERCOM

Intercom  
Pairing

Last-Come,  
First-Served

Two-Way  
Intercom

Multi-Way  
Intercom

Three-Way  
Conference  
Phone Call with  
Intercom Users

Group Intercom

Mesh Intercom  
Conference  
with Bluetooth  
Intercom  
Participant

Universal  
Intercom



4. Tap **Save** and check that your friend **(B)** is paired with **you (A)** correctly.
5. Tap **Scan** (📷) and repeat steps 3-4 to pair with **Intercom Friends (C)** and **(D)**.

**Note:** The **Smart Intercom Pairing (SIP)** is not compatible with Sena products that use **Bluetooth 3.0** or **below**.



# 8. BLUETOOTH INTERCOM

## 8.1.2 Using the Button

Intercom Pairing

Last-Come, First-Served

Two-Way Intercom

Multi-Way Intercom

Three-Way Conference Phone Call with Intercom Users

Group Intercom

Mesh Intercom Conference with Bluetooth Intercom Participant

Universal Intercom



1. The **users (You, B)** enter into **Intercom Pairing**.

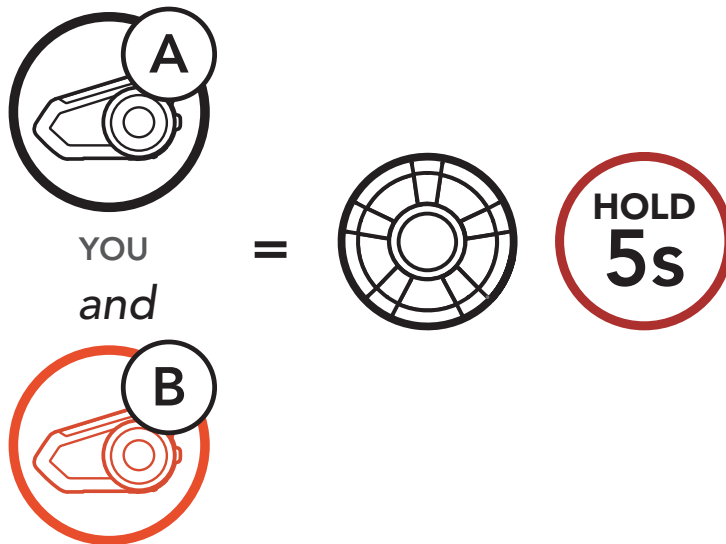

Blinking 



2. The **users' headsets** will be automatically paired.

Turns blue 

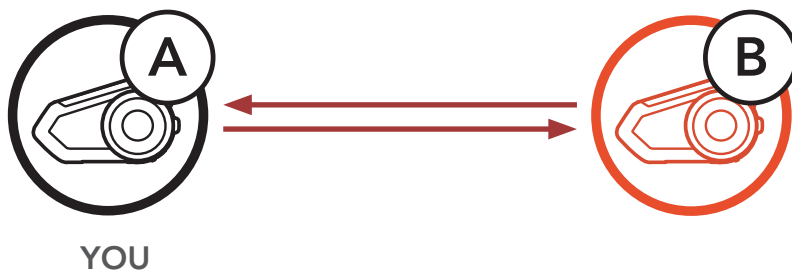

3. Repeat the steps above to pair with **other headsets (C and D)**.



# 8. BLUETOOTH INTERCOM

## 8.2 Last-Come, First-Served

The intercom pairing queue is **Last-Come, First-Served**. If a headset has multiple paired headsets for intercom conversations, the last paired headset is set as the **First Intercom Friend**. For example, after the pairing procedures listed above, **headset (D)** is the **First Intercom Friend** of headset (A). **Headset (C)** is the **Second Intercom Friend** of headset (A), and **headset (B)** is the **Third Intercom Friend** of headset (A).

### Intercom Pairing Order

### Last-Come, First-Served

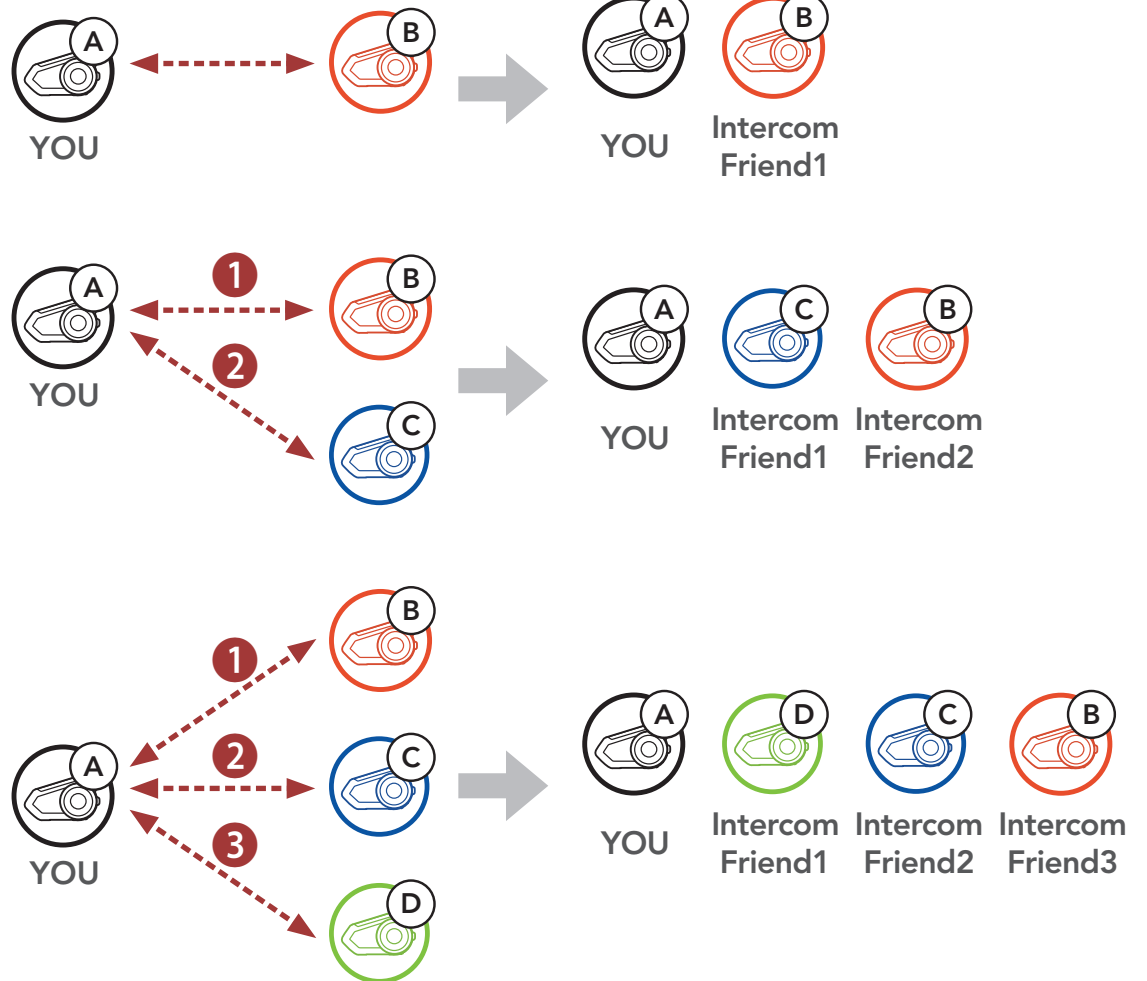

Intercom Pairing

Last-Come, First-Served

Two-Way Intercom

Multi-Way Intercom

Three-Way Conference Phone Call with Intercom Users

Group Intercom

Mesh Intercom Conference with Bluetooth Intercom Participant

Universal Intercom



## 8. BLUETOOTH INTERCOM

### 8.3 Two-Way Intercom

You can start or end an intercom conversation with an Intercom Friend by tapping the **Jog Dial**.

1. Tap once for Intercom **Friend 1**.

**Start/End with Intercom Friend 1**

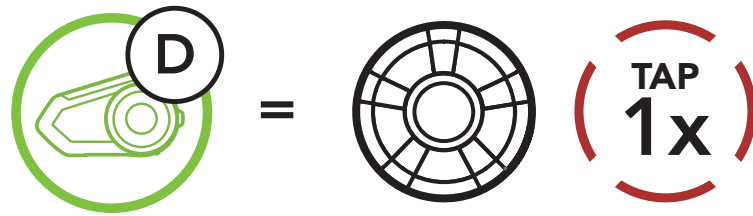

2. Tap twice for Intercom **Friend 2**.

**Start/End with Intercom Friend 2**

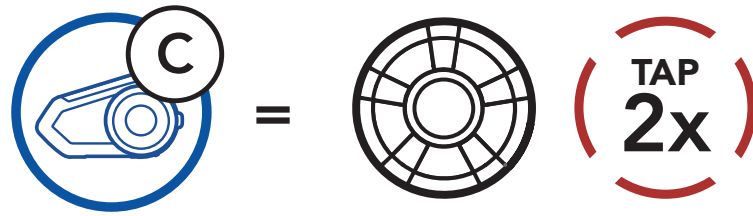

3. Tap three times for Intercom **Friend 3**.

**Start/End with Intercom Friend 3**

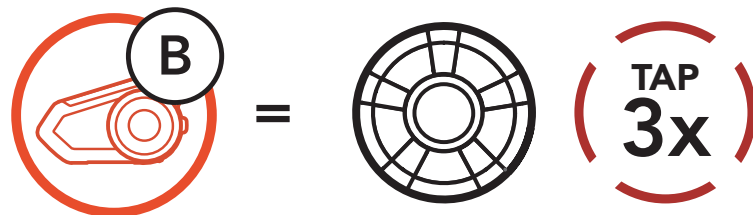

Intercom  
Pairing

Last-Come,  
First-Served

Two-Way  
Intercom

Multi-Way  
Intercom

Three-Way  
Conference  
Phone Call with  
Intercom Users

Group Intercom

Mesh Intercom  
Conference  
with Bluetooth  
Intercom  
Participant

Universal  
Intercom



## 8. BLUETOOTH INTERCOM

### 8.4 Multi-Way Intercom

Intercom  
Pairing

Last-Come,  
First-Served

Two-Way  
Intercom

Multi-Way  
Intercom

Three-Way  
Conference  
Phone Call with  
Intercom Users

Group Intercom

Mesh Intercom  
Conference  
with Bluetooth  
Intercom  
Participant

Universal  
Intercom

**Multi-Way Intercom** enables conference-call-style conversations with up to three **Intercom Friends** at the same time. While **Multi-Way Intercom** is in progress, mobile phone connection is temporarily disconnected. However, as soon as **Multi-Way Intercom** terminates, the mobile phone connection will be reestablished.

#### 8.4.1 Starting a Three-Way Intercom Conference

**You (A)** can have a **Three-Way Intercom Conference** with two other **Intercom Friends (B & C)** by establishing two intercom connections simultaneously.

1. Pair your headset (A) with those of two other **Intercom Friends (B & C)**. Please refer to **Section 8.1: "Intercom Pairing."** for pairing instructions.

Pair with Intercom Friends B & C

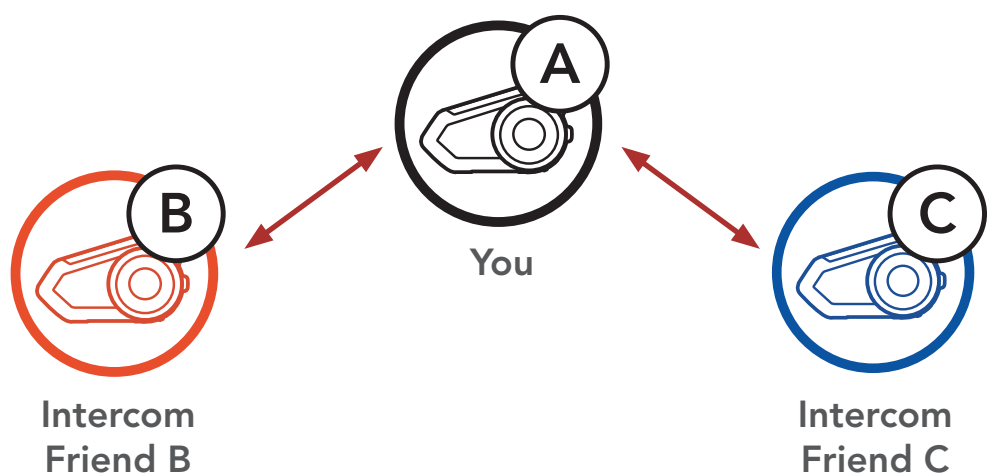





Intercom  
Pairing

Last-Come,  
First-Served

Two-Way  
Intercom

Multi-Way  
Intercom

Three-Way  
Conference  
Phone Call with  
Intercom Users

Group Intercom

Mesh Intercom  
Conference  
with Bluetooth  
Intercom  
Participant

Universal  
Intercom

## 8. BLUETOOTH INTERCOM

2. Start an intercom conversation with one of the two friends in your intercom group. For example, **you (A)** may start an intercom conversation with the **Intercom Friend (B)**. Or, **Intercom Friend (B)** may start an intercom call with **you (A)**.

### Starting an Intercom Conversation with Intercom Friend B

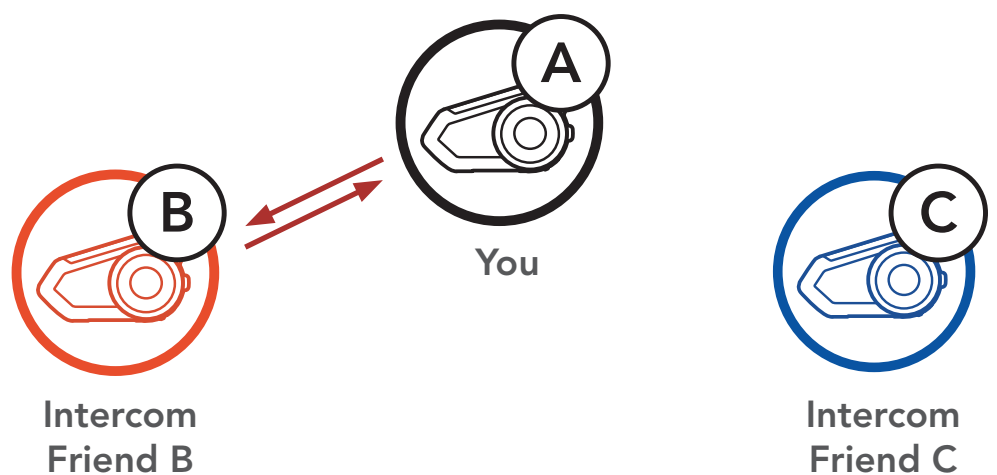

3. Then, **you (A)** can call the second **Intercom Friend (C)**, or the second **Intercom Friend (C)** may join the intercom by making an intercom call to **you (A)**.

### Starting an Intercom Conversation with Intercom Friend C

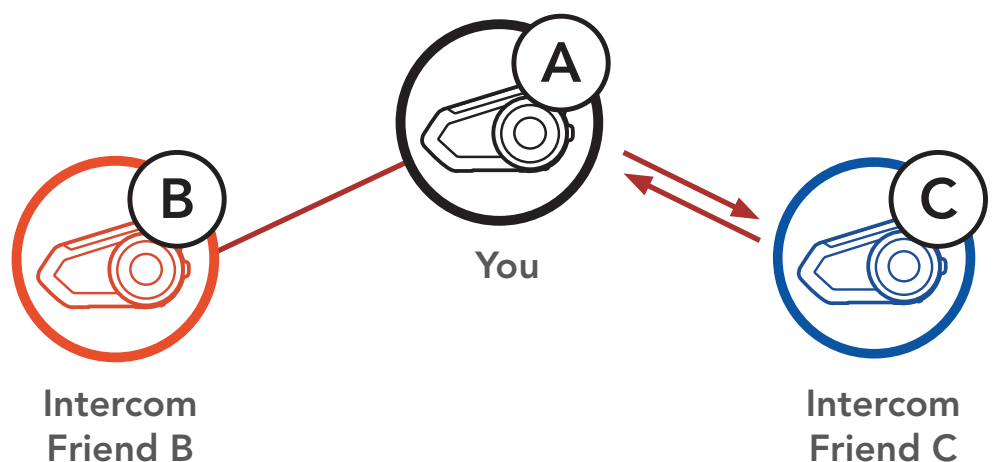



## 8. BLUETOOTH INTERCOM

4. Now **you (A)** and two **Intercom Friends (B & C)** are having a **Three-Way Intercom Conference**.

### Three-Way Intercom

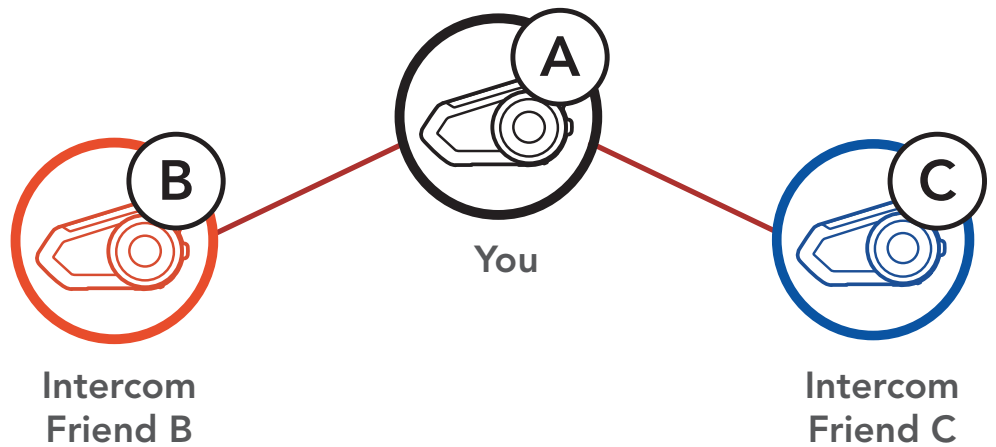

### 8.4.2 Starting a Four-Way Intercom Conference

With three **Intercom Friends** connected, a new participant (**D**) can make it a **Four-Way Intercom Conference** by making an intercom call to either (**B**) or (**C**).

### Starting a Four-Way Intercom

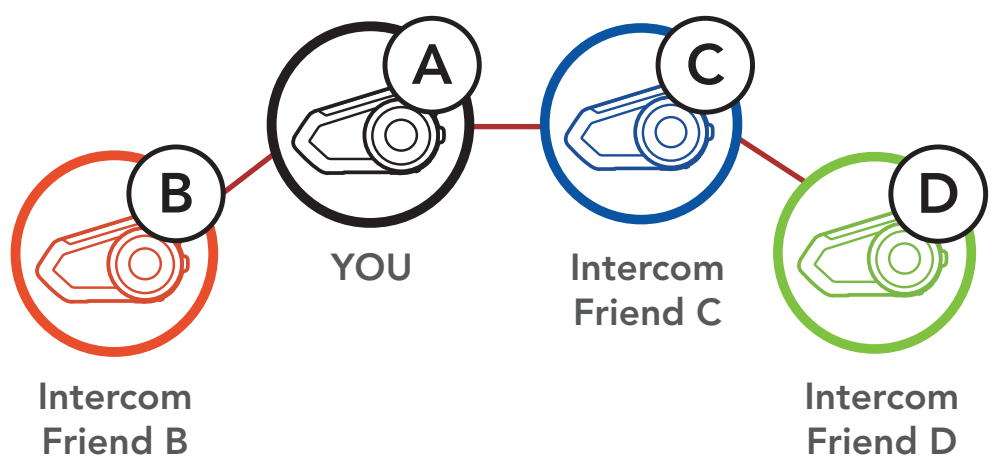

Intercom  
Pairing

Last-Come,  
First-Served

Two-Way  
Intercom

Multi-Way  
Intercom

Three-Way  
Conference  
Phone Call with  
Intercom Users

Group Intercom

Mesh Intercom  
Conference  
with Bluetooth  
Intercom  
Participant

Universal  
Intercom



## 8. BLUETOOTH INTERCOM

### 8.4.3 Ending Multi-Way Intercom

1. Press the **Jog Dial** for **1 second** until you hear a beep to terminate all intercom connections.
2. Tap the **Jog Dial** to disconnect from your first **Intercom Friend**. Double tap the **Jog Dial** to disconnect from your second **Intercom Friend**.

### 8.5 Three-Way Conference Phone Call with Intercom Users

You can have a **Three-Way Conference Phone Call** by adding an **Intercom Friend** to the mobile phone conversation.

1. During a mobile phone call, tap the **Jog Dial** **once, twice or, three times** to invite one of your **Intercom Friends** to the conversation.

#### Invite an Intercom Friend into Phone Conference

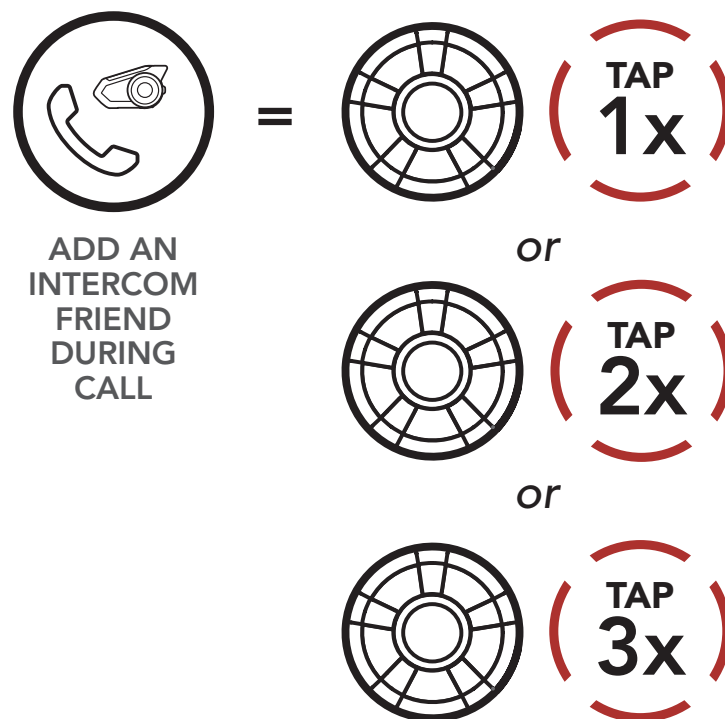

Intercom Pairing

Last-Come, First-Served

Two-Way Intercom

Multi-Way Intercom

Three-Way Conference Phone Call with Intercom Users

Group Intercom

Mesh Intercom Conference with Bluetooth Intercom Participant

Universal Intercom



## 8. BLUETOOTH INTERCOM

2. To disconnect the intercom during a conference phone call, tap the **Jog Dial once, twice or three times.**

### Disconnect Intercom Friend from Conference

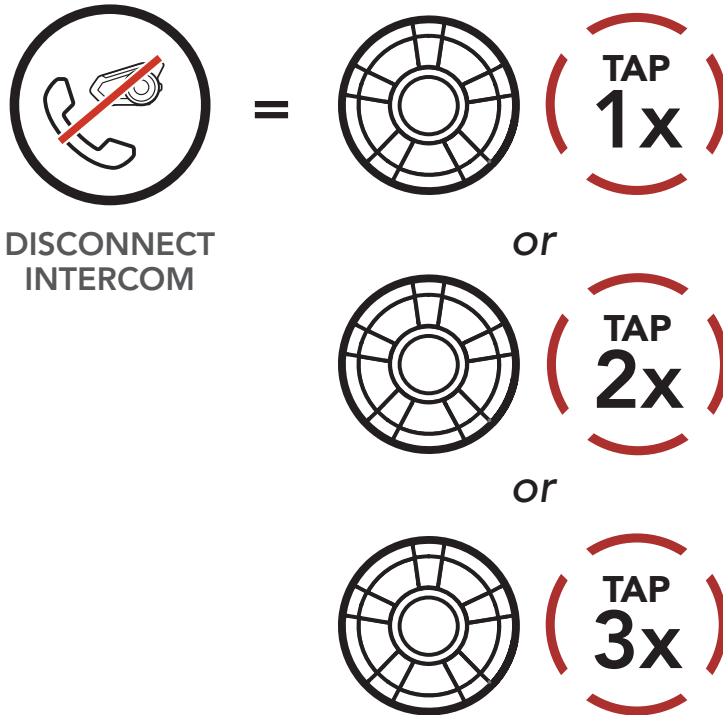

Intercom Pairing

Last-Come, First-Served

Two-Way Intercom

Multi-Way Intercom

Three-Way Conference Phone Call with Intercom Users

Group Intercom

Mesh Intercom Conference with Bluetooth Intercom Participant

Universal Intercom

3. To disconnect the mobile phone call during a conference phone call, tap the **Phone Button.**

### End Phone Call from Conference

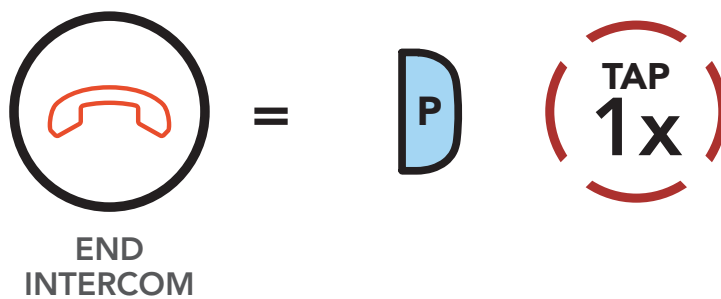

**Note:** When you have an incoming intercom call during a mobile phone call, you will hear high-toned double beeps.



## 8. BLUETOOTH INTERCOM

### 8.6 Group Intercom

**Group Intercom** allows you to instantly create a **Multi-Way Conference Intercom** with three of the most recently paired headsets.

1. Go through intercom pairing with up to three headsets you want to have **Group Intercom** with.
2. Press the **Ambient Mode Button** for **1 second** to begin **Group Intercom**. The LED will flash green and you will hear a voice prompt, "**Group intercom.**"

#### Start Group Intercom

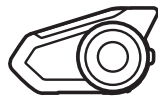
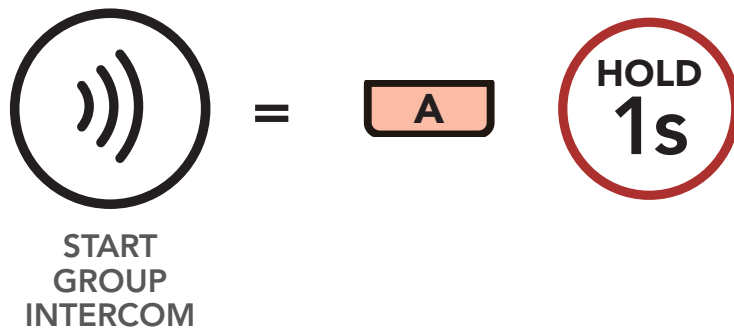

"Group intercom"

3. When all of the headsets are connected together, everyone will hear the voice prompt, "**Group intercom connected.**"

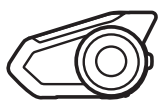

"Group intercom connected"



= Green LED Flashing

BLUETOOTH LED STATUS

Intercom Pairing

Last-Come, First-Served

Two-Way Intercom

Multi-Way Intercom

Three-Way Conference Phone Call with Intercom Users

Group Intercom

Mesh Intercom Conference with Bluetooth Intercom Participant

Universal Intercom



## 8. BLUETOOTH INTERCOM

- To terminate **Group Intercom**, press the **Ambient Mode Button** for **1 second** during **Group Intercom**. You will hear a voice prompt, **"Group intercom terminated."**

### End Group Intercom

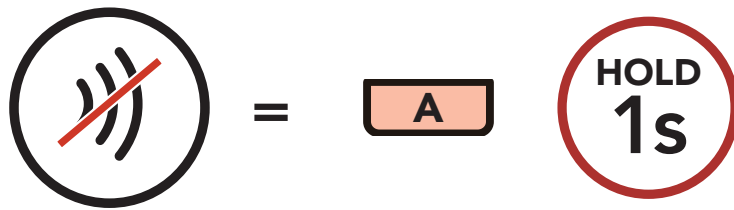

END GROUP  
INTERCOM

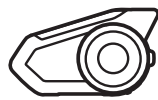

*"Group intercom terminated"*

### 8.7 Mesh Intercom Conference with Bluetooth Intercom Participant

Users can use the existing Bluetooth intercom and **Mesh Intercom** function at the same time. In this case, it is recommended to communicate with other Sena headsets via Bluetooth intercom connection and use **Mesh Intercom** between **30K** headsets. A user who is in **Open Mesh** or **Group Mesh** when using **Mesh Intercom** is able to include up to 3 of their Bluetooth intercom friends. You can start a Two-Way Intercom conversation with one of your three Intercom Friends to include them in the Mesh. Please refer to **Section 8.3: "Two-Way Intercom."** for more details. Or, you can use "Group Intercom" to include all of your Bluetooth intercom friends in the Mesh. Please refer to **Section 8.6: "Group Intercom."** for more details.

Intercom  
Pairing

Last-Come,  
First-Served

Two-Way  
Intercom

Multi-Way  
Intercom

Three-Way  
Conference  
Phone Call with  
Intercom Users

Group Intercom

Mesh Intercom  
Conference  
with Bluetooth  
Intercom  
Participant

Universal  
Intercom



## 8. BLUETOOTH INTERCOM

Intercom  
Pairing

Last-Come,  
First-Served

Two-Way  
Intercom

Multi-Way  
Intercom

Three-Way  
Conference  
Phone Call with  
Intercom Users

Group Intercom

Mesh Intercom  
Conference  
with Bluetooth  
Intercom  
Participant

Universal  
Intercom

### Note:

- The audio quality will be reduced if a **30K** connects to 2 or more Bluetooth intercom friends while in **Open Mesh** or **Group Mesh** when using **Mesh Intercom**.
- If a closed loop is created, as shown below, each user will experience severe noise issues. Sena recommends that a closed loop not be created.

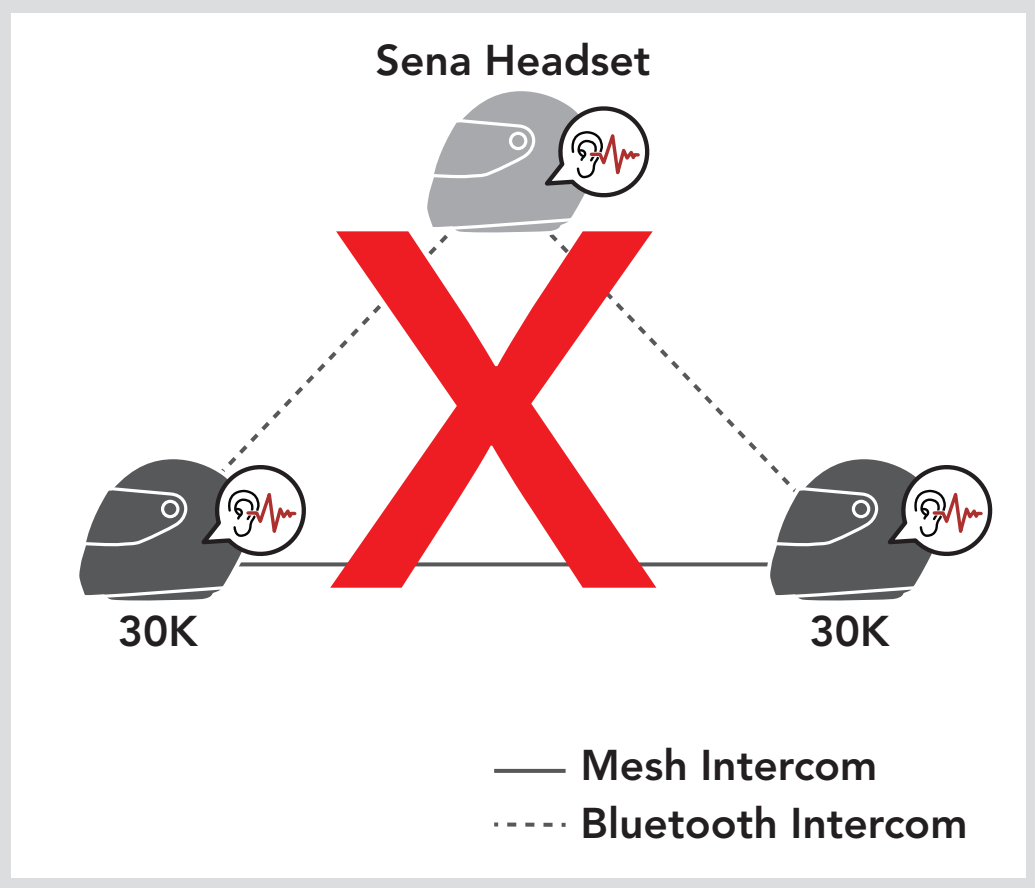



## 8. BLUETOOTH INTERCOM

- If **Bluetooth intercom** is accidentally turned on during **Mesh Intercom** communication between **30K** headsets, as shown below, you will hear a voice prompt, **"Mesh intercom disabled. Bluetooth intercom connected"** every **1 minute**. If you turn off the Bluetooth Intercom or turn off the **Mesh Intercom**, the voice prompt will no longer come out.

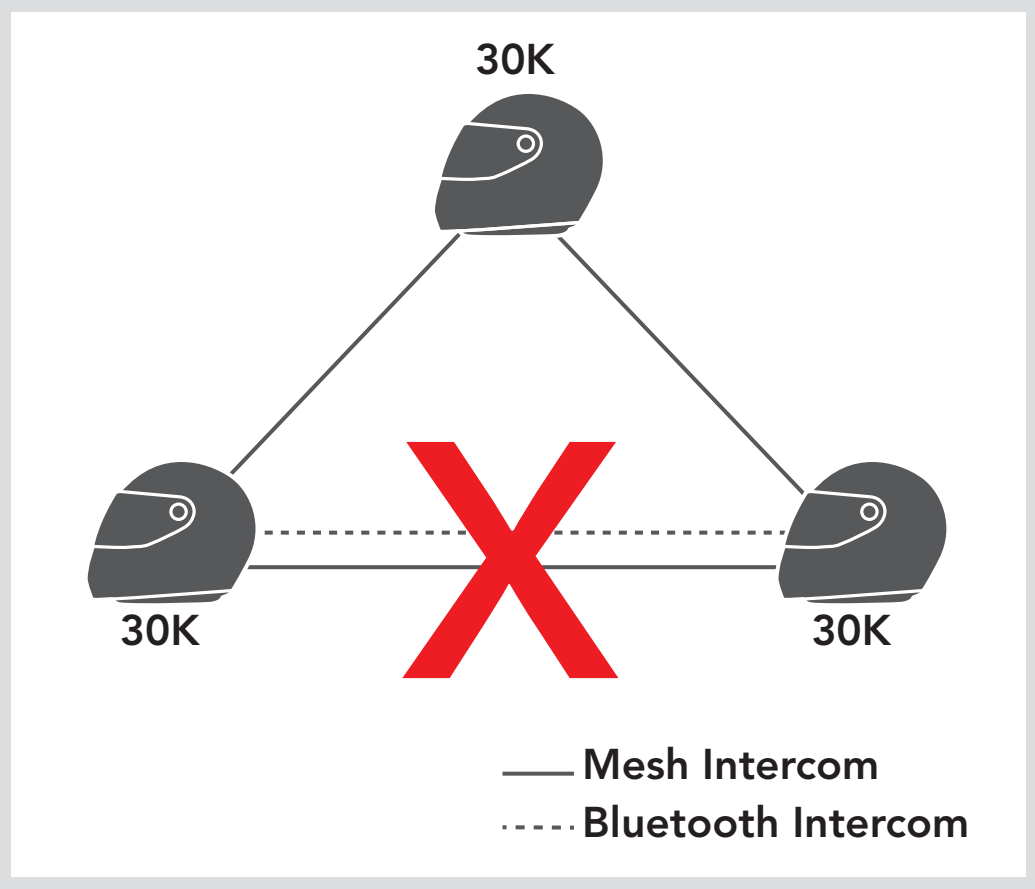

Intercom  
Pairing

Last-Come,  
First-Served

Two-Way  
Intercom

Multi-Way  
Intercom

Three-Way  
Conference  
Phone Call with  
Intercom Users

Group Intercom

Mesh Intercom  
Conference  
with Bluetooth  
Intercom  
Participant

Universal  
Intercom

### 8.8 Universal Intercom

**Universal Intercom** allows you to have intercom conversations with users of non-Sena Bluetooth headsets. You can pair your headset with only one non-Sena headset at a time. The intercom distance depends on the performance of the Bluetooth headset to which it's connected. When a non-Sena Bluetooth headset is paired with the Sena headset, if another Bluetooth device is paired via **Second Mobile Phone Pairing**, it will be disconnected.





## 8. BLUETOOTH INTERCOM

1. Execute **Universal Intercom** in the **Headset Configuration Menu**.

Access Universal Intercom in the Configuration Menu

Intercom Pairing

Last-Come, First-Served

Two-Way Intercom

Multi-Way Intercom

Three-Way Conference Phone Call with Intercom Users

Group Intercom

Mesh Intercom Conference with Bluetooth Intercom Participant

Universal Intercom

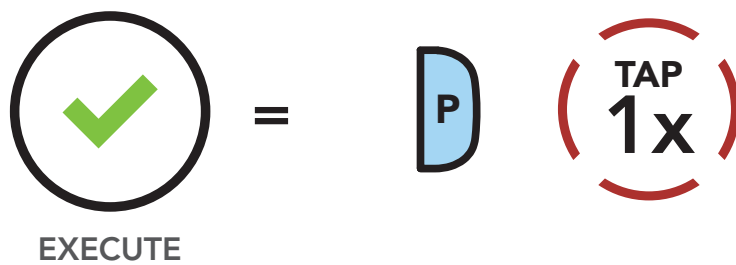
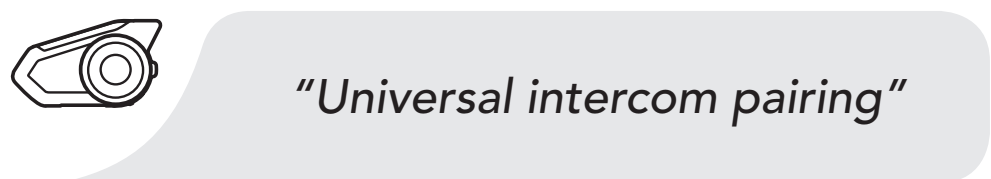
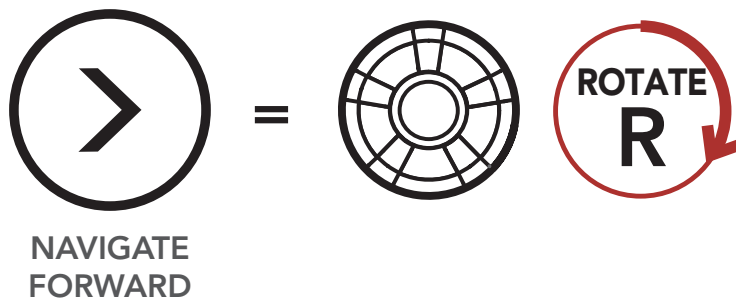
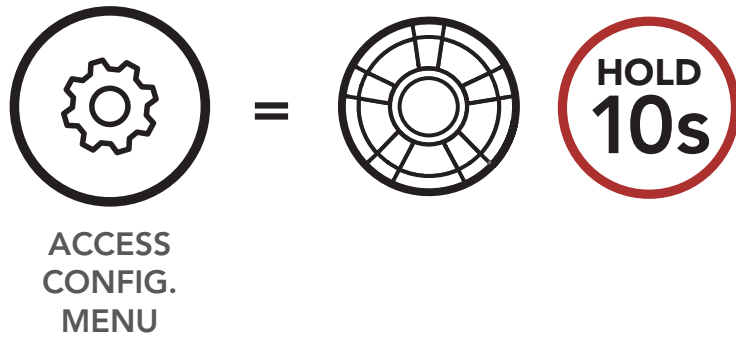

2. Put the non-Sena Bluetooth headset in Pairing Mode. The headset will automatically pair with a non-Sena Bluetooth headset.



## 8. BLUETOOTH INTERCOM

### 8.8.1 Two-Way Universal Intercom

You can initiate the **Universal Intercom** connection with non-Sena Bluetooth headsets using the same intercom connection method as you would between other Sena headsets.

You may start/end a **Two-Way Universal Intercom** using the same way as you do in a normal **Two-Way Intercom**. Please refer to **Section 8.3: "Two-Way Intercom."**



### 8.8.2 Multi-Way Universal Intercom

You can have **Multi-Way Intercom** communication with up to **three Intercom Friends** using non-Sena headsets. Some non-Sena headsets may not support **Multi-Way Universal Intercom**.

You may make the **Multi-Way Universal Intercom** call the same way as a normal four-way intercom call.

You may start/end a **Multi-Way Universal Intercom** using the same way as you do in a normal **Multi-Way Intercom**. Please refer to **Section 8.4: "Multi-Way Intercom."**

Intercom  
Pairing

Last-Come,  
First-Served

Two-Way  
Intercom

Multi-Way  
Intercom

Three-Way  
Conference  
Phone Call with  
Intercom Users

Group Intercom

Mesh Intercom  
Conference  
with Bluetooth  
Intercom  
Participant

Universal  
Intercom



## 8. BLUETOOTH INTERCOM

### Three-Way Universal Intercom

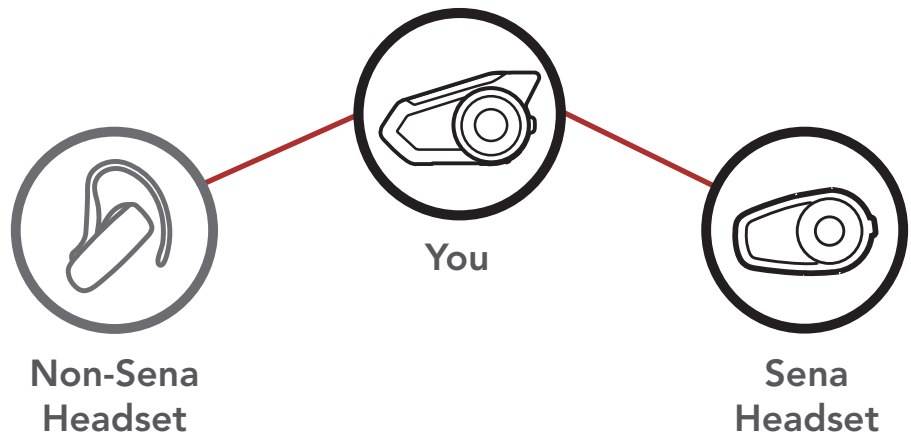

### Four-Way Universal Intercom

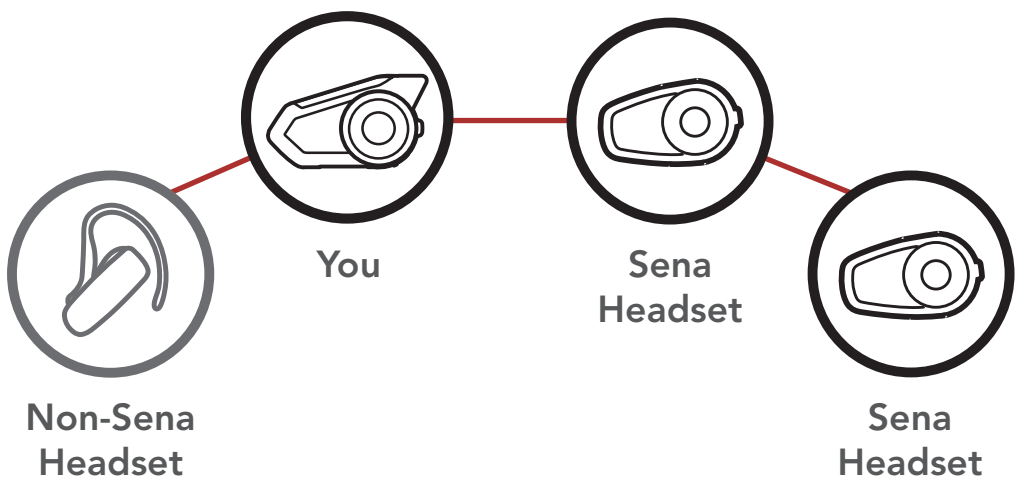
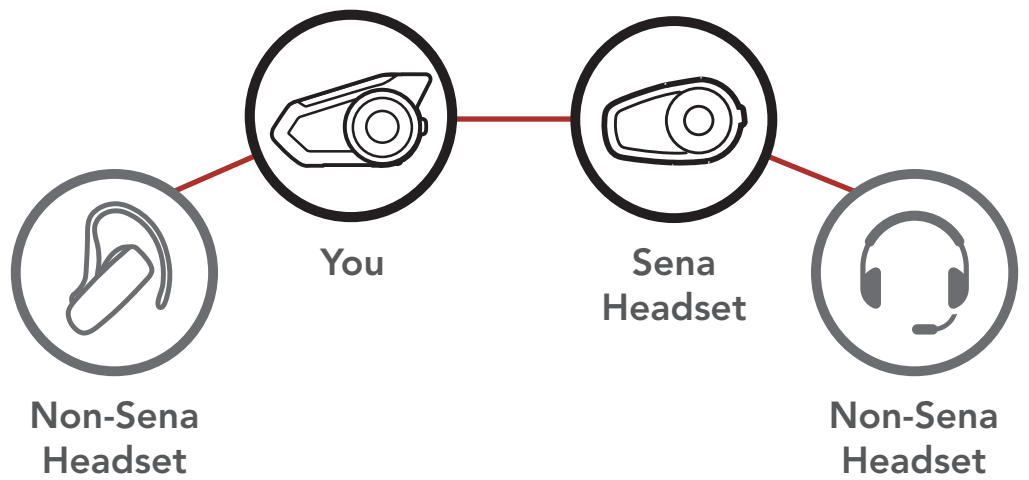

Intercom  
Pairing

Last-Come,  
First-Served

Two-Way  
Intercom

Multi-Way  
Intercom

Three-Way  
Conference  
Phone Call with  
Intercom Users

Group Intercom

Mesh Intercom  
Conference  
with Bluetooth  
Intercom  
Participant

Universal  
Intercom



## 9. AMBIENT MODE

You can hear the ambient sound outside of your helmet by activating the **Ambient Mode**. To activate the **Ambient Mode**, press the **Ambient Mode Button** twice which is placed on the bottom of the clamp unit. To deactivate the **Ambient Mode**, press the **Ambient Mode Button** twice again.

### Ambient Mode

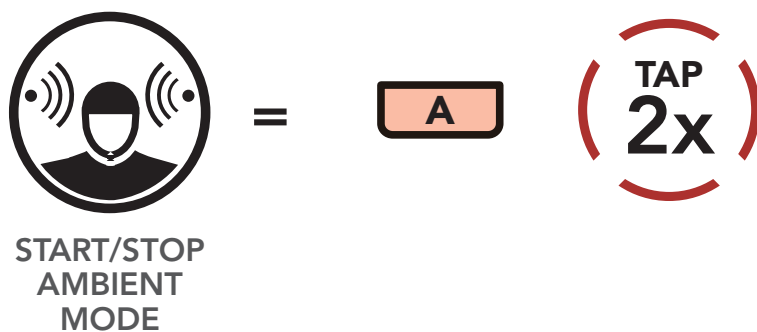

**Note:** The **Ambient Mode** has higher priority than mobile phone, so you cannot listen to music, or have an intercom conversation if the **Ambient Mode** is activated.



## 10. VOICE COMMAND

The **Voice Command** of the headset allows you to operate certain operations by simply using your voice. You can control the headset completely hands-free using the voice recognition.

- The **Voice Command** function works only with English commands.

### Speak a Voice Command List

Mode Status	Function	Voice Command
Standby/ Bluetooth Intercom/ Mesh Intercom/ Music	Check battery	"Hey Sena, Check Battery"
	Volume Up	"Hey Sena, Volume Up"
	Volume Down	"Hey Sena, Volume Down"
	Phone Pairing	"Hey Sena, Phone Pairing"
	Bluetooth Intercom Pairing	"Hey Sena, Pairing Intercom"
	Start/End each Bluetooth Intercom	"Hey Sena, Intercom [One, Two, Three]"
Standby/ Bluetooth Intercom/ Music	Turn on Mesh Intercom	"Hey Sena, Mesh On"
Mesh Intercom	Turn off Mesh Intercom	"Hey Sena, Mesh Off"
	Mesh Grouping	"Hey Sena, Mesh Grouping"
	Switch to Open Mesh	"Hey Sena, Open Mesh"
	Switch to Group Mesh	"Hey Sena, Group Mesh"
	End the Bluetooth intercom and Mesh intercom	"Hey Sena, End Intercom"



## 10. VOICE COMMAND

Mode Status	Function	Voice Command
Standby/ Bluetooth Intercom/ Mesh Intercom	Play Music	"Hey Sena, Play Music"
Music	Music - Next Track	"Hey Sena, Next"
	Music - Previous Track	"Hey Sena, Previous"
Music	Pause Music	"Hey Sena, Stop Music"
Answer an Incoming Call		"Answer"
Ignore an Incoming Call		"Ignore"

**Note:** Voice command performance may vary based on the environmental conditions including riding speed, helmet type and ambient noise. To improve the performance, minimize wind noise on the microphone by using a large microphone sponge and closing the visor.



# 11. FUNCTION PRIORITY AND FIRMWARE UPGRADES

## Function Priority

## Firmware Upgrades

### 11.1 Function Priority

- (highest)** Ambient Mode
  - Mobile phone
  - Mesh Intercom/Bluetooth Intercom
  - Music sharing via Bluetooth stereo music
- (lowest)** Bluetooth stereo music

A lower-priority function gets interrupted by a higher-priority function. For example, stereo music will be interrupted by an **Intercom Conversation**; an **Intercom Conversation** will be interrupted by an incoming mobile phone call.

### 11.2 Firmware Upgrades

The headset supports firmware upgrades. You can upgrade the firmware using the **Sena Device Manager**.

[Click Here to Visit sena.com](https://www.sena.com)



## 12. CONFIGURATION

### 12.1 Headset Configuration Setting

Headset  
Configuration  
Setting

Software  
Configuration  
Setting

The headset can be configured by following a series of voice prompts. Further details about each of these settings will be explained on the following pages.

1. To access the **Configuration Menu**, press and hold the **Jog Dial** for **10 seconds** until you hear the voice prompt, **"Configuration menu."**

#### Accessing the Configuration Menu

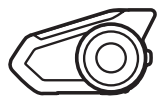
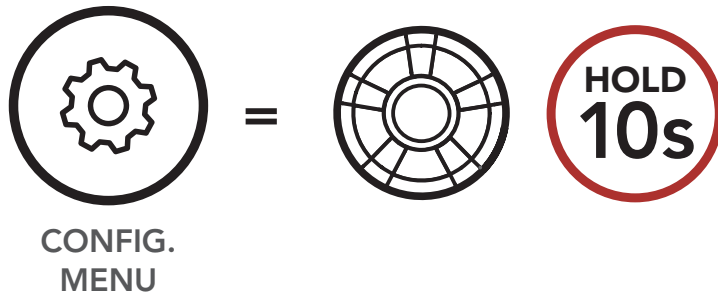

*"Configuration menu"*

2. Rotate the **Jog Dial** clockwise or counterclockwise to navigate between the menus. You will hear voice prompts for each menu item. The list of functions is shown in the **"Headset Configuration Menu"** on page 73.

#### Navigating Forward through the Menu

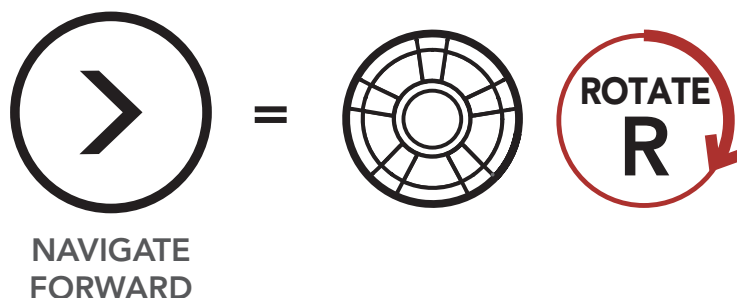

*"[Menu prompt]"*





## 12. CONFIGURATION

Headset  
Configuration  
Setting

Software  
Configuration  
Setting

### Navigating Backward through the Menu

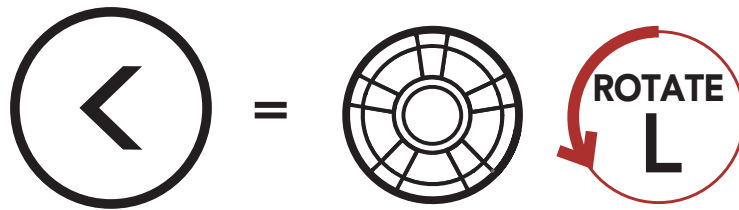

NAVIGATE  
BACKWARD

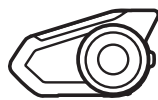

"[Menu prompt]"

3. You can enable the feature or execute the command by tapping the **Phone Button**.

### Execute Menu Options

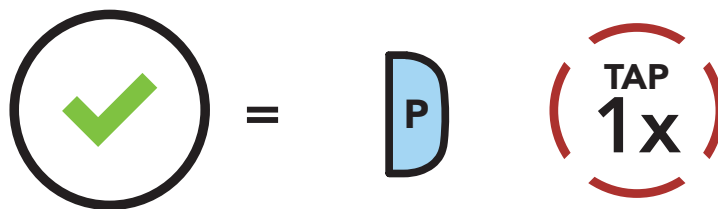

EXECUTE

### Headset Configuration Menu

Rotate the Jog Dial clockwise or counterclockwise	Tap the Phone Button
Delete All Pairings	Execute
Remote Control Pairing	Execute
Universal Intercom Pairing	Execute
Exit	Execute



Headset  
Configuration  
Setting

Software  
Configuration  
Setting

## 12. CONFIGURATION

### 12.1.1 Delete All Pairings

**Delete All Bluetooth Pairing Information** stored in the headset.

### 12.1.2 Remote Control Pairing

You can remotely control the headset using **Sena** Remote Control devices (sold separately).

1. Turn on the headset and the Remote Control device.
2. Execute **Remote Control Pairing**.
3. Enter pairing mode in the Remote Control device. The headset will automatically connect with the Remote Control device in pairing mode.

## 12.2 Software Configuration Setting

You can change the settings of the headset through the **Sena Device Manager** or the **Sena Motorcycles App**.



Sena  
Motorcycles



Sena Device  
Manager



Headset  
Configuration  
Setting

Software  
Configuration  
Setting

## 12. CONFIGURATION

### 12.2.1 Headset Language

You can select the device language. The selected language is maintained even when the headset is rebooted.

### 12.2.2 Mesh Reach-Out (Default: Disable)

When the **Mesh Reach-Out** is enabled, a Mesh Reach-Out request message can be sent or received. If the **Mesh Reach-Out** is disabled, a Mesh Reach-Out request message cannot be sent or received.

### 12.2.3 Audio Equalizer (Default: Off)

Increase or decrease the decibel level of different frequency ranges of audio.

- **Balance** will adjust all of the frequency ranges to be the same volume level (0 dB).
- **Bass Boost** will increase the bass range of audio (20 Hz - 250 Hz).
- **Mid Boost** will increase the mid range of audio (250 Hz - 4 kHz).
- **Treble Boost** will increase the high range of audio (4 kHz - 20 kHz).

### 12.2.4 VOX Phone (Default: Enable)

If this feature is enabled, you can answer incoming calls by voice. When you hear a ringtone for an incoming call, you can answer the phone by saying a word such as **"Hello"** loudly or by blowing air into the microphone. **VOX Phone** is temporarily disabled if you are connected to intercom. If this feature is disabled, you have to tap the **Jog Dial** or the **Phone Button** to answer an incoming call.



Headset  
Configuration  
Setting

Software  
Configuration  
Setting

## 12. CONFIGURATION

### 12.2.5 VOX Intercom (Default: Disable)

If **VOX Intercom** is enabled, you can initiate an intercom conversation with the last connected intercom friend by voice. When you want to start intercom, say a word such as **"Hello"** loudly or blow air into the microphone. If you start an intercom conversation by voice, the intercom terminates automatically when you and your intercom friend remain silent for **20 seconds**. However, if you manually start an intercom conversation by tapping the **Jog Dial**, you have to terminate the intercom conversation manually. However, if you start the intercom by voice and end it manually by tapping the **Jog Dial**, you will not be able to start intercom by voice temporarily. In this case, you have to tap the **Jog Dial** to restart the intercom. This is to prevent repeated unintentional intercom connections by strong wind noise. After rebooting the headset, you can start the intercom by voice again.

### 12.2.6 VOX Sensitivity (Default: 3)

**Vox Sensitivity** can adjust the sensitivity of Vox Phone and Vox Intercom. **Level 5** is the highest sensitivity setting and **level 1** is the lowest.



Headset  
Configuration  
Setting

Software  
Configuration  
Setting

## 12. CONFIGURATION

### 12.2.7 Bluetooth Intercom Audio Multitasking (Default: Disabled)

**Audio Multitasking (Bluetooth Intercom Audio Multitasking and Mesh Intercom Audio Multitasking)** allows you to have an intercom conversation while simultaneously listening to music or GPS instructions. The overlaid audio is played in the background with reduced volume whenever there is an intercom conversation and will return to normal volume once the conversation is finished.

The **Mesh Intercom Audio Multitasking** feature is always **on**.

#### Note:

- For **Bluetooth Intercom Audio Multitasking** to work properly, you need to power the headset off and on. **Please restart the headset.**
- **Bluetooth Intercom Audio Multitasking** will be activated during two-way intercom conversations with a headset that also supports this feature.
- Some GPS devices may not support this feature.
- The **Audio Multitasking** feature can be configured through the **Intercom-Audio Overlay Sensitivity** and the **Audio Overlay Volume Management** settings.



Headset  
Configuration  
Setting

Software  
Configuration  
Setting

## 12. CONFIGURATION

### 12.2.8 Intercom-Audio Overlay Sensitivity (Default: 3)

The music and GPS volume will be lowered to play in the background if you talk over the intercom while the overlaid audio is playing. You can adjust the intercom sensitivity to activate this background audio mode. **Level 1** has the lowest sensitivity and **level 5** has the highest sensitivity.

**Note:** If your voice is not louder than the sensitivity of the selected level, the overlaid audio will not be lowered.

### 12.2.9 Audio Overlay Volume Management (Default: Disable)

The music and GPS overlaid audio reduces in volume whenever there is an ongoing intercom conversation. If **Audio Overlay Volume Management** is enabled, the volume level of the overlaid audio will not be reduced during an intercom conversation.

### 12.2.10 HD Intercom (Default: Enable)

**HD Intercom** enhances the two-way intercom audio from normal quality to HD quality. **HD Intercom** will become temporarily disabled when you enter into a multi-way intercom. If this feature is disabled, the two-way intercom audio will change to normal quality.

**Note:**

- The intercom distance of **HD Intercom** is relatively shorter than that of normal intercom.
- **HD Intercom** will become disabled temporarily when **Bluetooth Intercom Audio Multitasking** is enabled.



Headset  
Configuration  
Setting

Software  
Configuration  
Setting

## 12. CONFIGURATION

### 12.2.11 HD Voice (Default: Enable)

**HD Voice** allows you to communicate in high-definition during phone calls. This feature increases the quality so that the audio will be crisp and clear during phone call conversations.

If this feature is enabled, incoming phone calls will interrupt intercom conversations and audio from the SR10 will not be heard during intercom conversations. Three-Way Conference Phone Call with Intercom Participant will not be available if **HD Voice** is enabled.

**Note:**

- Refer to the manufacturer of your Bluetooth device that will be connected to the headset to see if it supports **HD Voice**.
- **HD Voice** is active only when **Bluetooth Intercom Audio Multitasking** is disabled.

### 12.2.12 Smart Volume Control (Default: Disable)

Enabling **Smart Volume Control** automatically changes the level of the speaker volume based on the level of the environment noise. You can enable it by setting the sensitivity to **low**, **medium** or **high**.



Headset  
Configuration  
Setting

Software  
Configuration  
Setting

## 12. CONFIGURATION

### 12.2.13 Sidetone (Default: Disable)

**Sidetone** is audible feedback of your own voice. It helps you to naturally speak at the correct level according to varying helmet noise conditions. If this feature is enabled, you can hear what you are speaking during an intercom conversation or a phone call.

### 12.2.14 Voice Prompt (Default: Enable)

You can disable **Voice Prompts** by software configuration settings, but the following voice prompts are always on.

- Headset configuration settings menu, battery level indicator, speed dial

### 12.2.15 Advanced Noise Control™ (Default: Enable)

When **Advanced Noise Control** is enabled, the background noise is reduced during an intercom conversation. When it is disabled, the background noise is mixed with your voice during intercom.





**Fault Reset**

**Factory Reset**

## 13. TROUBLESHOOTING

Please visit **sena.com** for answers to frequently asked questions. This detailed online FAQ section deals with troubleshooting, illustrates case studies and contains tips on using the headset.

[Click Here to Visit sena.com](https://www.sena.com)

### 13.1 Fault Reset

When the headset is not working properly, you can easily reset the unit:

1. Locate the **Pinhole Fault Reset Button** below on the back of the main unit.
2. Gently insert a paperclip into the hole and tap the **Pinhole Fault Reset Button** with light pressure.

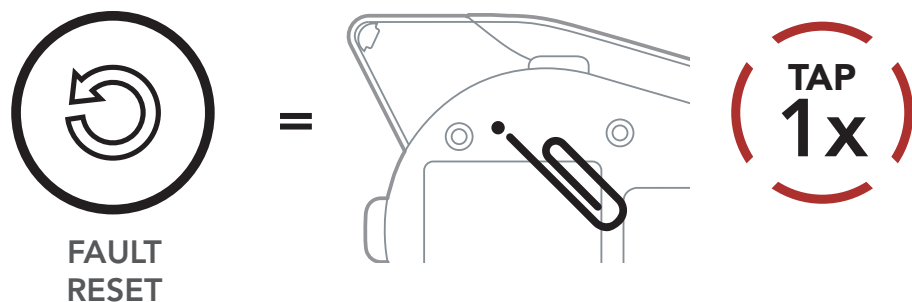

3. The headset will shut down.

**Note:** Fault Reset will not restore the headset to factory default settings.



# 13. TROUBLESHOOTING

## 13.2 Factory Reset

Fault Reset

Factory Reset

To erase all of your settings and start fresh, the headset can be restored to factory default settings using the **Factory Reset** feature.

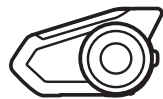
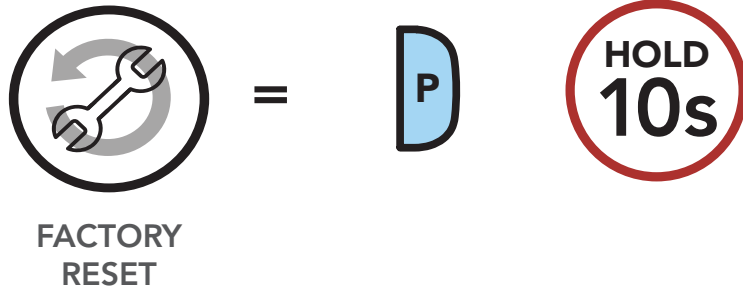

*"Factory reset"*

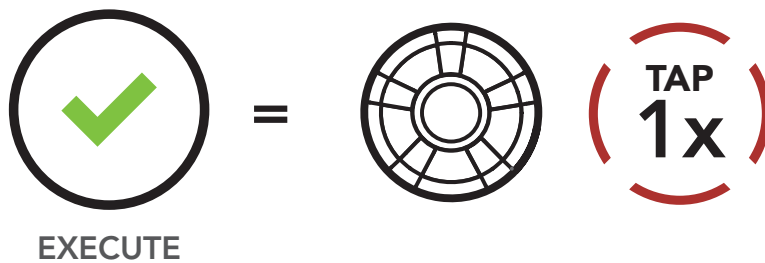
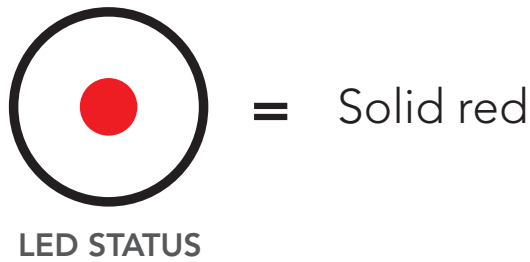

*"Headset reset, good-bye"*

**Note:** If you press the **Phone Button** or don't press the **Jog Dial** within **5 seconds**, the reset attempt is canceled and the headset returns to standby mode. You will hear a voice prompt saying **"Canceled."**

# SENA

Copyright © 2023 Sena Technologies Co., Ltd.  
All rights reserved.

© 1998–2023 Sena Technologies Co., Ltd. All rights reserved.

Sena Technologies Co., Ltd. reserves the right to make any changes and improvements to its product without providing prior notice.

Sena™ is a trademark of Sena Technologies Co., Ltd. or its subsidiaries in the USA and other countries. SF1™, SF2™, SF4™, SFR™, SRL™, SRL2™, SRL3™, SRL-EXT™, SRL-Mesh™, Momentum™, Momentum INC™, Momentum Lite™, Momentum Pro™, Momentum INC Pro™, Momentum EVO™, Cavalry™, Latitude SR™, Latitude SX™, Latitude S1™, 30K™, 33i™, 50S™, 50R™, 50C™, 5S™, 5R™, 5R LITE™, 20S EVO™, 20S™, 10S™, 10C™, 10C PRO™, ProRide EVO™, 10C EVO™, 10U™, 10Upad™, 10R™, ACS10™, ACS-RAM™, C1™, C10™, CAST™, 3S™, 3S PLUS™, SMH5™, SMH5-FM™, SMH5 MultiCom™, SMH10™, SMH10R™, SPH10™, SPH10H-FM™, Savage™, Prism Tube WiFi™, Prism™, Bluetooth Audio Pack for GoPro®, IMPULSE™, FURY™, R1™, R1 EVO™, R1 EVO CS™, R2™, R2 EVO™, R2X™, M1™, M1 EVO™, RUMBA™, RC1™, RC3™, RC4™, STRYKER™, Handlebar Remote™, Wristband Remote™, PowerPro Mount™, Powerbank™, FreeWire™, WiFi Docking Station™, WiFi Sync Cable™, WiFi Adapter™, +mesh™, +Mesh Universal™, MeshPort Blue™, MeshPort Red™, MeshPort Black™, Econo™, OUTLANDER M™, OUTRUSH™, OUTRUSH R™, OUTSTAR™, OUTSTAR S™, OUTFORCE™, OUTRIDE™, OUTRUSH M™, EcoCom™, Parani A10™, Parani A20™, Parani M10™, pi™, Snowtalk™, Snowtalk2™, SR10™, SR10i™, SM10™, SPIDER RT1™, SPIDER ST1™, X1™, X1 Pro™, X1S™, EXPAND™, EXPAND BOOM™, EXPAND MESH™, Bluetooth Mic & Intercom™, Tufftalk™, Tufftalk Lite™, Tufftalk M™, NAUTITALK Bosun™, NAUTITALK N2R™ are trademarks of Sena Technologies Co., Ltd. or its subsidiaries. These trademarks may not be used without the express permission of Sena.

GoPro® is a registered trademark of Woodman Labs of San Mateo, California. Sena Technologies Co., Ltd. ("Sena") is not affiliated with Woodman Labs, Inc. The Sena Bluetooth Pack for GoPro® is an aftermarket accessory specially designed and manufactured by Sena Technologies Co., Ltd. for the GoPro® Hero3 and Hero4 allowing for Bluetooth capabilities.

The Bluetooth® word mark and logos are owned by the Bluetooth SIG, Inc. and any use of such marks by Sena is under license. iPhone® and iPod® touch are registered trademarks of Apple Inc.

Address: 152 Technology Drive Irvine, CA 92618