



USER GUIDE

Firmware Version: 1.2.x

Last updated on Jan 31, 2025

SOC

MOTORCYCLE CAMERA & COMMUNICATION SYSTEM
WITH MESH INTERCOM™

— SOUND BY —
harman/kardon®



The firmware version 1.2.x indicates that this manual is applicable to all firmware updates within the version 1.2 series.

BEFORE GETTING STARTED

Sena Motorcycles App

Download the **Sena Motorcycles App** from the **Google Play Store** or the **App Store**.



Sena Camera App

Download the **Sena Camera App** from the **Google Play Store** or the **App Store**.

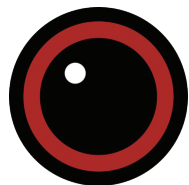

Built-in Wi-Fi in the Headset

- IEEE 802.11 b/g/n/a
- Working distance: within 15 m

Note:

- When the camera is powered on, Wi-Fi is automatically powered on and set to its default settings.
- Wi-Fi will automatically be terminated if:
 - You do not use Wi-Fi on the product for 3 minutes.
 - You do not use the **Sena Camera App** for 3 minutes.
- If you want to reactivate the Wi-Fi after it is terminated, you will need to restart the camera.

50 Series Updater Software for Windows PC or Mac

Download the **50 Series Updater Software** at sena.com.

TABLE OF CONTENTS

1.	ABOUT THE 50C	9
1.1	Product Features	9
1.2	Product Details	10
1.3	Package Contents	11
2.	INSTALLING THE HEADSET ON YOUR HELMET	12
2.1	Helmet Installation	12
2.1.1	Using the Gear Clamp Unit	12
2.1.2	Using the Clamp Unit	13
2.1.3	Using the Glued Surface Mounting Plate	14
2.2	Installing the Speakers	15
2.3	Installing the Microphone	16
2.3.1	Installing the Wired Boom Microphone	16
2.3.2	Installing the Wired Microphone	17
2.4	Adjust the Angle	19
2.4.1	Using the Gear Clamp Unit	19
2.4.2	Using the Clamp Unit	20
3.	BASIC OPERATION	21
3.1	Charging	21
3.2	Legend	22
3.3	Powering On and Off	22
3.4	Volume Adjustment	22
3.5	Checking the Battery Level	23
3.6	Low Battery Warning	23
4.	CAMERA OPERATION	24
4.1	Camera On or Off	24
4.2	Camera Modes	24
4.3	Video Recording	25

4.4	Video Mode (Default: Normal Recording Mode)	26
4.4.1	Timelapse Video Mode	26
4.4.2	Loop Recording Mode	26
4.5	Taking Photos (Default: Normal Recording Mode)	26
4.5.1	Single Shot Mode	26
4.5.2	Burst Shot Mode	26
4.6	Video Tagging	27
4.7	Formatting SD Card	27
4.8	Changing the Wi-Fi Channel (Default: 5 GHz)	28
5.	PAIRING THE HEADSET WITH OTHER BLUETOOTH DEVICES	29
5.1	Phone Pairing	29
5.2	Second Mobile Phone Pairing	30
5.3	GPS Pairing	30
5.4	Advanced Selective Pairing: Hands-Free or A2DP Stereo	31
5.4.1	Phone Selective Pairing - Hands-Free Profile	31
5.4.2	Media Selective Pairing - A2DP Profile	31
6.	MOBILE PHONE USAGE	33
6.1	Making and Answering Calls	33
6.2	Siri and Google Assistant	33
6.3	Speed Dialing	34
6.3.1	Assigning Speed Dial Presets	34
6.3.2	Using Speed Dial Presets	34

7.	STEREO MUSIC	35
7.1	Playing Music with Bluetooth Devices	35
7.2	Music Sharing	35
7.2.1	Bluetooth Intercom Music Sharing	36
7.2.2	Mesh Intercom Music Sharing	36
8.	MESH INTERCOM	37
8.1	What is Mesh Intercom?	37
8.1.1	Open Mesh	38
8.1.2	Group Mesh	38
8.2	Starting Mesh Intercom	39
8.3	Using the Mesh in Open Mesh	39
8.3.1	Channel Setting (Default: channel 1)	39
8.4	Using Mesh in Group Mesh	40
8.4.1	Creating a Group Mesh	40
8.4.2	Joining an Existing Group Mesh	41
8.5	Enable/Disable Mic (Default: Enable)	42
8.6	Toggling Open Mesh/Group Mesh	42
8.7	Mesh Reach-Out Request	43
8.8	Reset Mesh	43
9.	BLUETOOTH INTERCOM	44
9.1	Intercom Pairing	44
9.1.1	Using the Smart Intercom Pairing (SIP)	44
9.1.2	Using the Button	45
9.2	Last-Come, First-Served	46
9.3	Two-Way Intercom	47
9.4	Multi-Way Intercom	48
9.4.1	Starting a Three-Way Intercom Conference	48
9.4.2	Starting a Four-Way Intercom Conference	49
9.4.3	Ending Multi-Way Intercom	49

9.5	Three-Way Conference Phone Call with Intercom Users	50
9.6	Group Intercom	51
9.7	Mesh Intercom Conference with Bluetooth Intercom Participant	51
10.	UNIVERSAL INTERCOM	53
10.1	Universal Intercom Pairing	53
10.2	Two-Way Universal Intercom	53
10.3	Multi-Way Universal Intercom	54
10.3.1	Three-Way Universal Intercom	54
10.3.2	Four-Way Universal Intercom	55
10.4	Mesh Intercom Conference with Two-way Universal Intercom Participant	56
11.	USING THE FM RADIO	57
11.1	FM Radio On/Off	57
11.2	Seek and Save Radio Stations	57
11.3	Scan and Save Radio Stations	58
11.4	Temporary Station Preset	58
11.5	Navigating Preset Stations	59
12.	VOICE COMMAND	60
13.	FUNCTION PRIORITY AND FIRMWARE UPDATE	62
13.1	Function Priority	62
13.2	Firmware Update	62
13.2.1	WiFi Charging Cable	62
13.2.2	50 Series Updater Software for Windows PC or Mac	62

14. CONFIGURATION SETTING	63
14.1 Headset Configuration Menu	63
14.1.1 Delete All Pairings	63
14.1.2 Remote Control Pairing	63
14.2 Software Configuration Setting	64
14.2.1 Language	64
14.2.2 Mesh Reach-Out (Default: Disable)	64
14.2.3 Equalizer (Default: Music Balance)	64
14.2.4 Audio Boost (Default: Enable)	64
14.2.5 VOX Phone (Default: Enable)	65
14.2.6 VOX Intercom (Default: Disable)	65
14.2.7 VOX Sensitivity (Default: 3)	65
14.2.8 HD Intercom (Default: Enable)	65
14.2.9 HD Voice (Default: Enable)	66
14.2.10 Bluetooth Intercom Audio Multitasking (Default: Disabled)	66
14.2.11 Intercom-Audio Overlay Sensitivity (Default: 3)	67
14.2.12 Audio Overlay Volume Management (Default: Disable)	67
14.2.13 Smart Volume Control (Default: Disable)	67
14.2.14 Sidetone (Default: Disable)	67
14.2.15 Voice Assistant (Default: Enable)	67
14.2.16 Voice Prompt (Default: Enable)	68
14.2.17 RDS AF Setting (Default: Disable)	68
14.2.18 FM Station Guide (Default: Enable)	68
14.2.19 Advanced Noise Control™ (Default: Enable)	68
14.3 Camera Configuration Setting	68
14.3.1 Photo Mode (Default: Single Shot Mode)	68
14.3.2 Video Mode (Default: Normal Recording Mode)	69
14.3.3 Video Resolution (Default: 2160P/30fps)	69
14.3.4 Timelapse Interval (Default: 1 sec)	69
14.3.5 Video Microphone Gain (Default: Medium)	69
14.3.6 Date Caption (Default: Off)	69
14.3.7 Smart Audio Mix (Always On)	69
14.3.8 Auto Camera Sleep (Default: On)	70
14.3.9 Format SD Card	70

15. TROUBLESHOOTING	71
15.1 Fault Reset	71
15.2 Factory Reset	71
15.3 The Camera's Warning	72
15.3.1 Memory is Full	72
15.3.2 No microSD Card	72
15.3.3 microSD Card Error	72
15.3.4 High Temperature	72

1. ABOUT THE 50C

1.1 Product Features



Bluetooth® 5.0



UHD Camera Integrated



Mesh Intercom up to 1.2 mi (2 km)*



Intercom up to 1.0 mi (1.6 km)*



Four-Way Intercom



Smart Audio Mix™



Wi-Fi Enabled



Audio Multitasking™

* in open terrain

1.2 Product Details

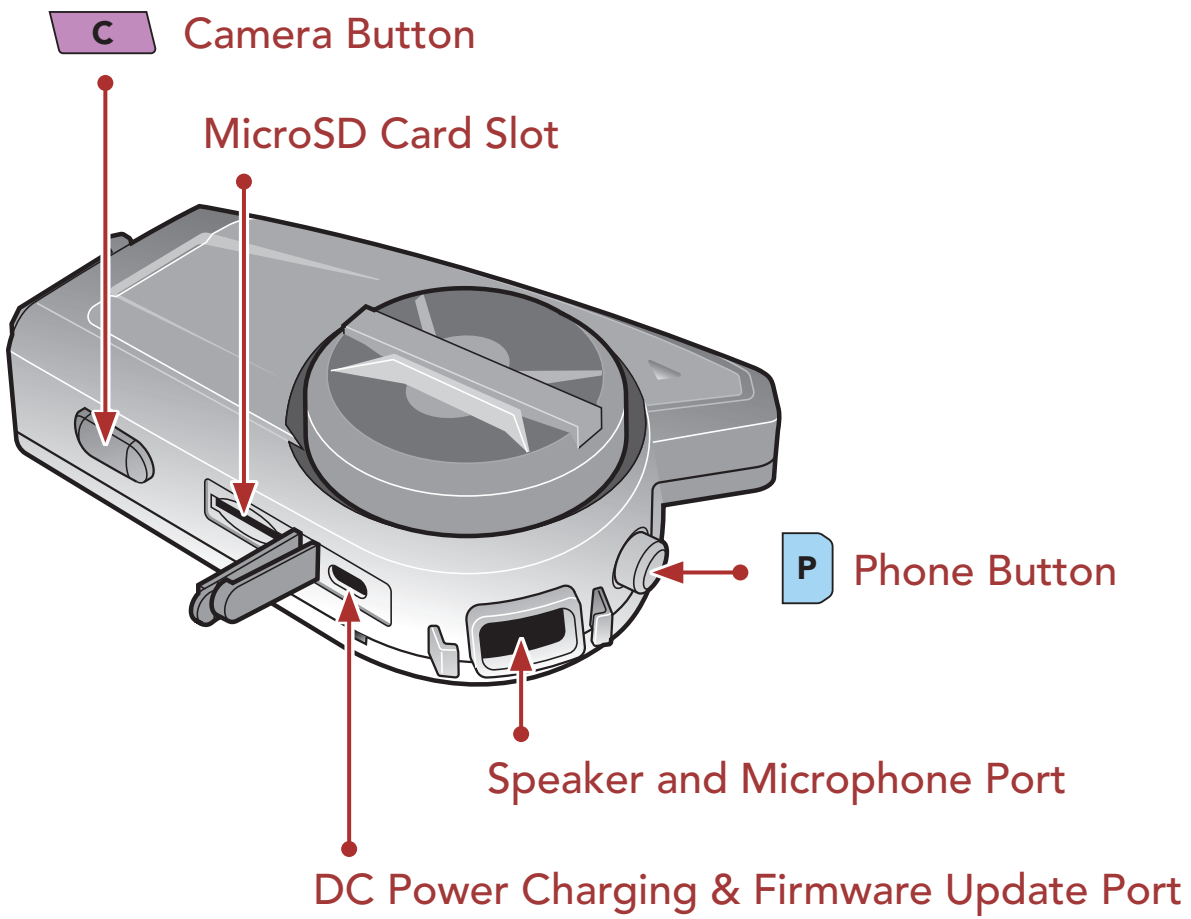
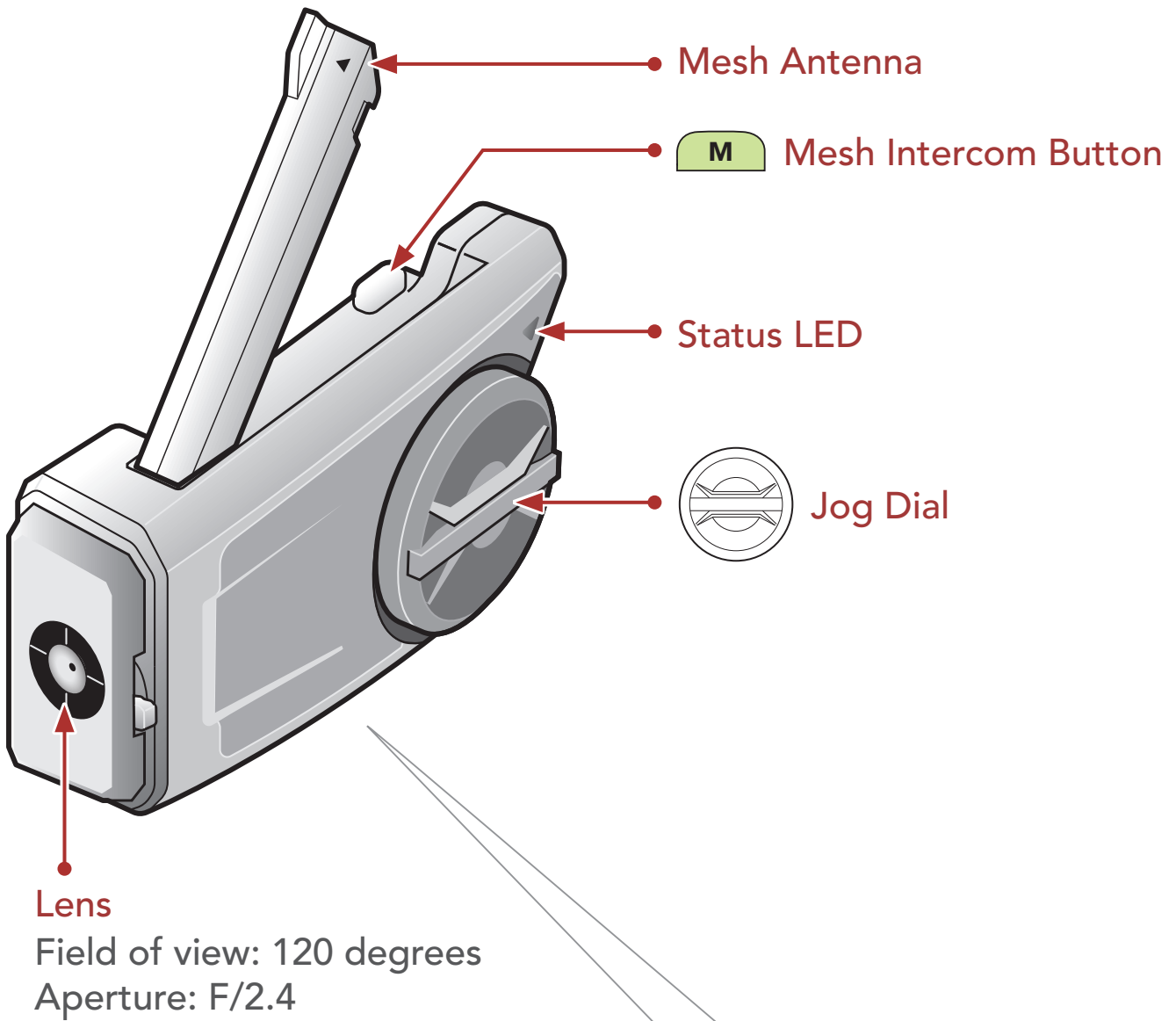

1.3 Package Contents

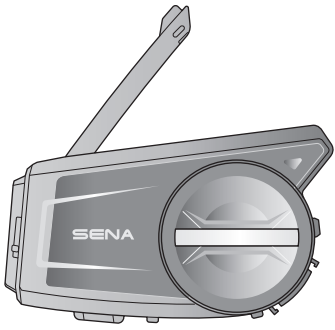

Headset Main Unit

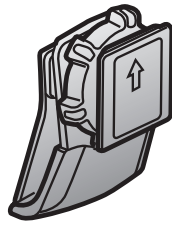

Gear Clamp Unit



Clamp Unit

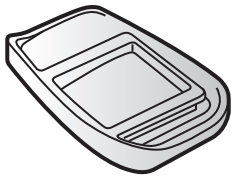

Glued Surface Mounting Plate

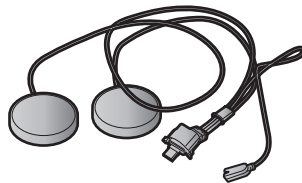

Speakers

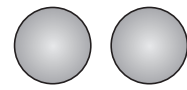

Speaker Pads (2)

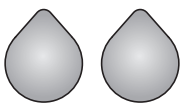

Hook and Loop Fasteners for Speakers (2)

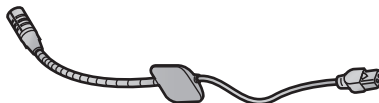

Wired Boom Microphone

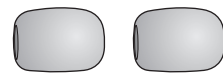

Microphone Sponges (2)

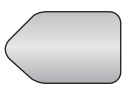

Hook and Loop Fastener for Boom Microphone

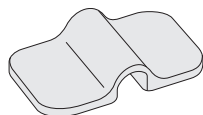

Boom Microphone Holder

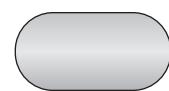

Hook and Loop Fastener for Holder



Wired Microphone



Hook and Loop Fastener for Wired Microphone

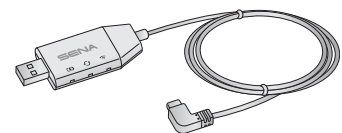

WiFi Charging Cable



Allen Wrench

2. INSTALLING THE HEADSET ON YOUR HELMET

2.1 Helmet Installation

2.1.1 Using the Gear Clamp Unit

1. Loosen the two screws on the back plate of the clamp unit with the included allen wrench.

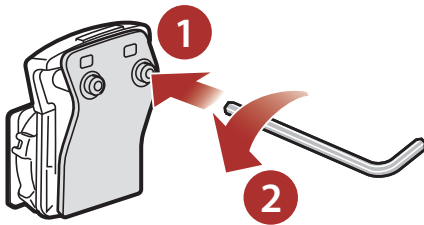

2. Insert the back plate of the clamp unit between the internal padding and external shell of the left side of the helmet.

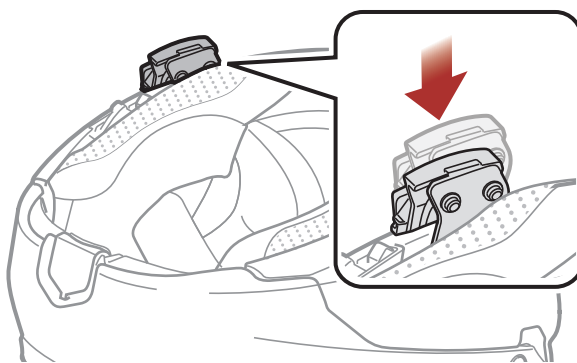

3. Tighten the two screws until the clamp unit is fastened firmly to the helmet.

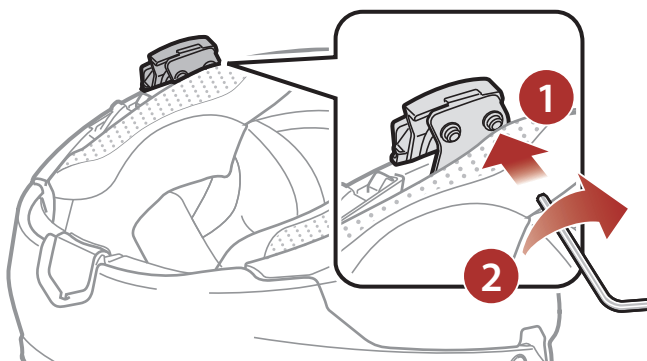

4. Insert a microSD card into the card slot to use the camera.

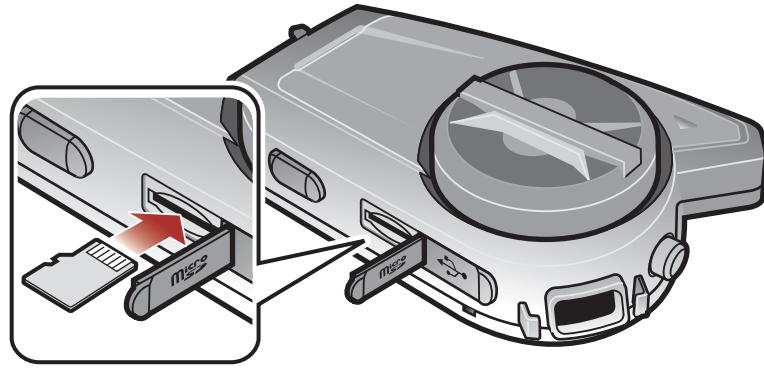

5. Attach the main unit to the clamp unit until you hear a click.

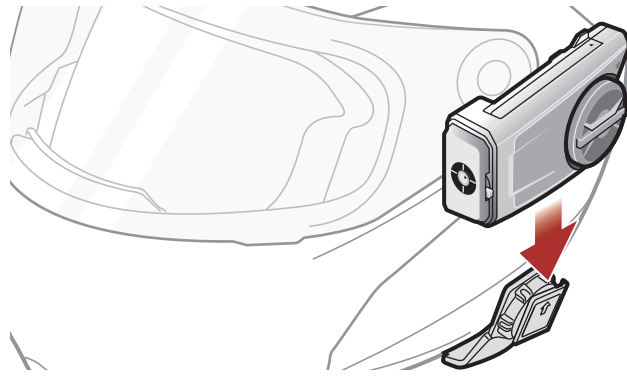

2.1.2 Using the Clamp Unit

1. Loosen the two screws on the back plate of the clamp unit with the included allen wrench.

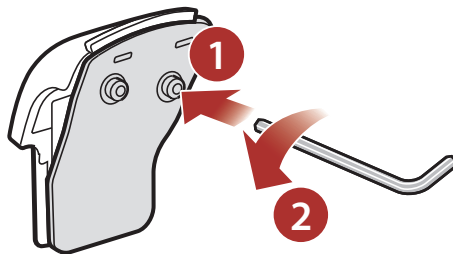

2. Insert the back plate of the clamp unit between the internal padding and external shell of the left side of the helmet.

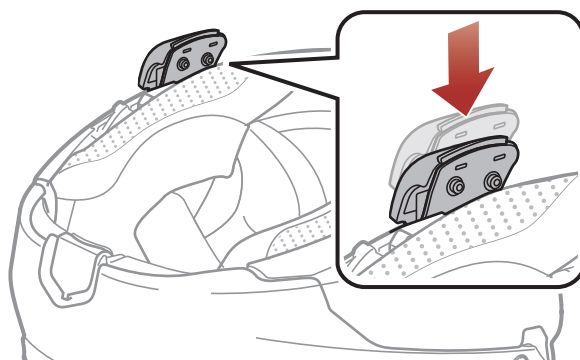

3. Tighten the two screws until the clamp unit is fastened firmly to the helmet.

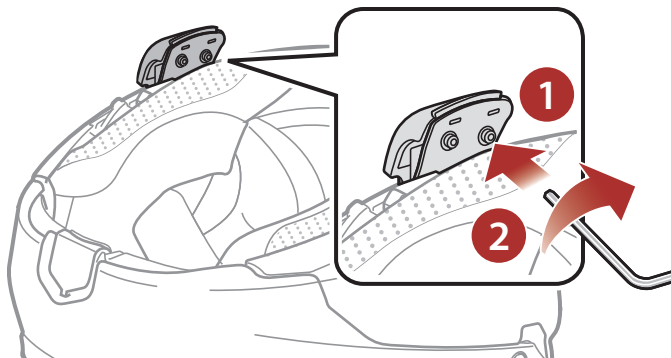

4. Insert a microSD card into the card slot to use the camera.

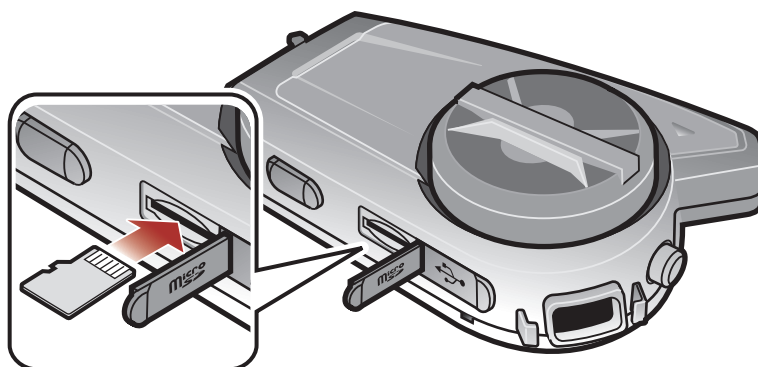

5. Attach the main unit to the clamp unit until you hear a click.

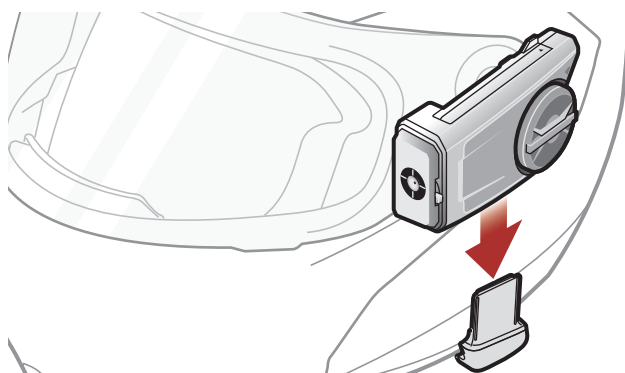

2.1.3 Using the Glued Surface Mounting Plate

If you cannot install the clamp unit on the helmet, you can use the glued surface mounting plate to attach the clamp unit to the surface of the helmet.

1. Clean the area on the left side of the helmet where you will attach the glued surface mounting plate with a moistened towel and dry thoroughly.
2. Peel off the cover of the adhesive tape of the glued surface mounting plate and attach it to the helmet.

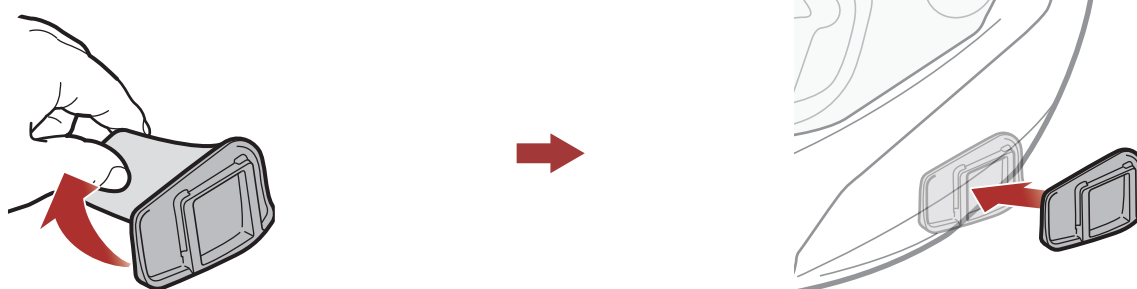

3. Make sure that the glued surface mounting plate sticks on the helmet firmly. Maximum adhesion occurs after 24 hours.
4. Attach the main unit to the glued surface mounting plate until you hear a click.

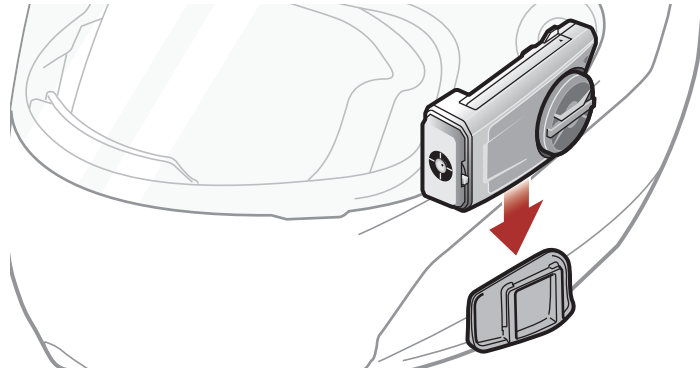

2.2 Installing the Speakers

1. Peel off each cover of the hook and loop fasteners for speakers to expose the adhesive surface. Then, attach the fasteners to the ear pockets inside the helmet.

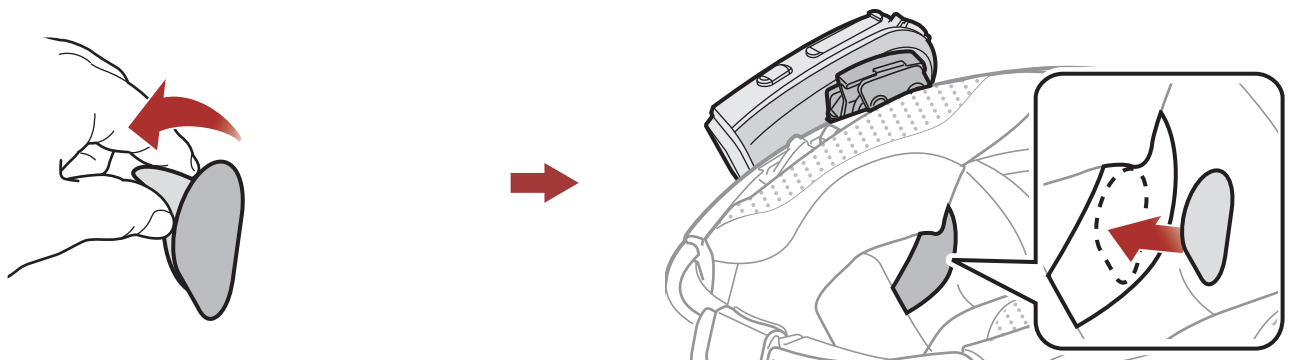

2. Attach the speakers to the hook and loop fasteners for speakers inside the helmet.

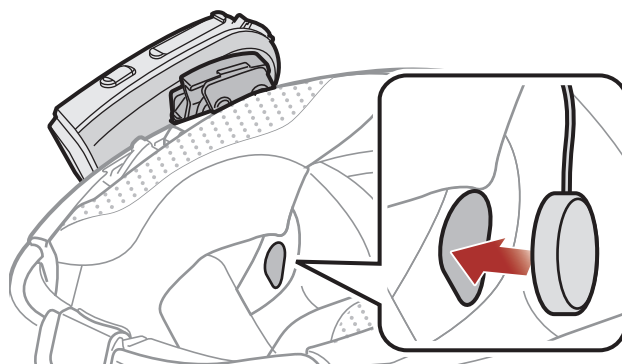

Note: If the helmet has deep ear pockets, you can use the speaker pads to bring the speakers closer to your ears.

2.3 Installing the Microphone

2.3.1 Installing the Wired Boom Microphone

1. Peel off the cover of the hook and loop fastener for wired boom microphone to expose the adhesive tape. Then, attach the hook and loop fastener on the inside surface of the left external shell.

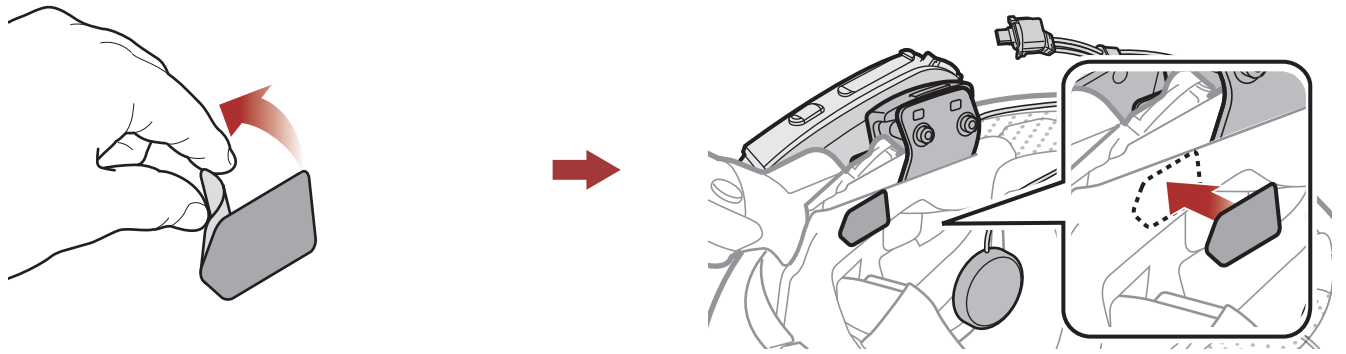

2. Attach the wired boom microphone's mounting plate to the hook and loop fastener.

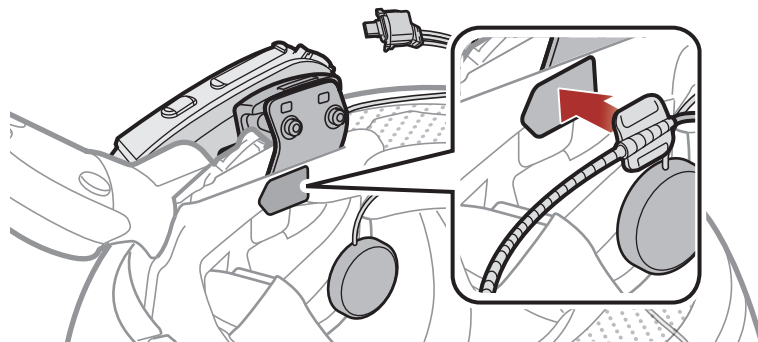

Note: You can use the boom microphone holder after attaching the hook and loop fastener for boom microphone holder on it to ensure secure installation.

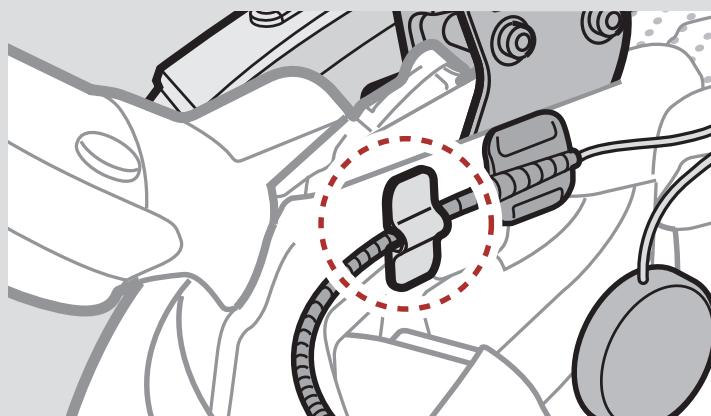

3. Position the microphone close to your mouth.

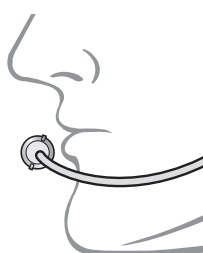

4. Align the arrows on the microphone and speaker cables and insert the microphone cable into the microphone connector.

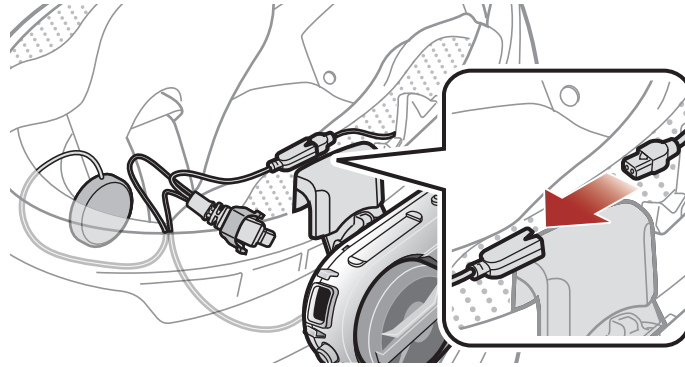

5. Insert the speaker cable into the speaker and microphone port to connect it to the main unit.

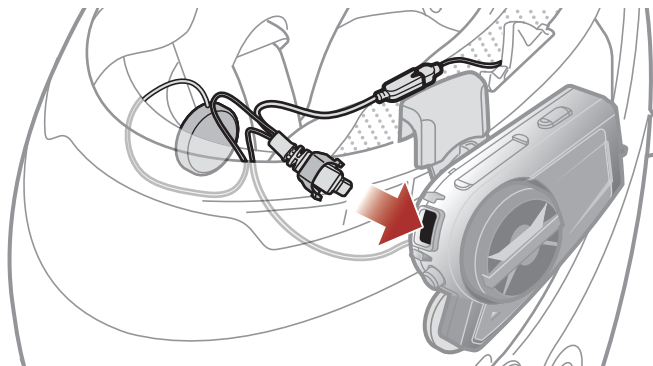

6. Close the cover of the speaker cable to lock the cable to the port.

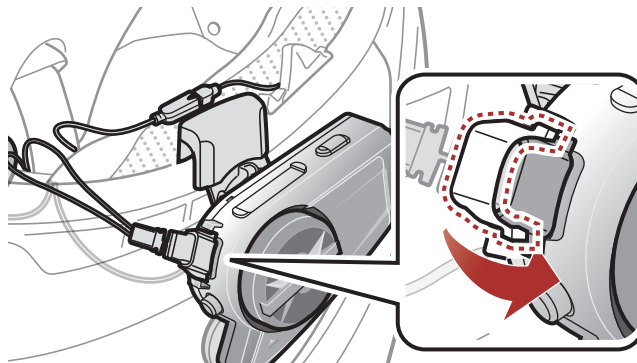

2.3.2 Installing the Wired Microphone

If you have a full face helmet, you can use the wired microphone.

1. Peel off the cover of the hook and loop fastener for wired microphone to expose the adhesive tape. Then, attach the hook and loop fastener on the inside of the helmet's chin guard.

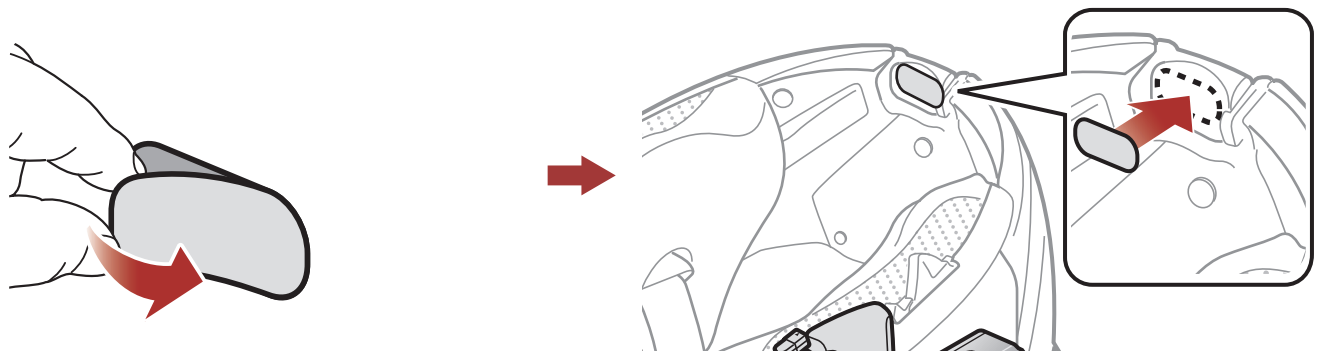

2. Attach the wired microphone to the hook and loop fastener for wired microphone.

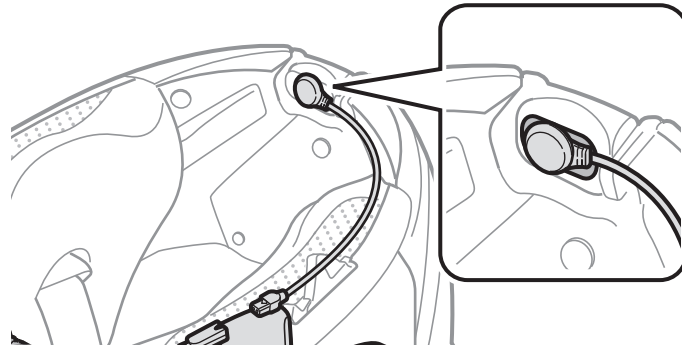

3. Align the arrows on the microphone and speaker cables and insert the microphone cable into the microphone connector.

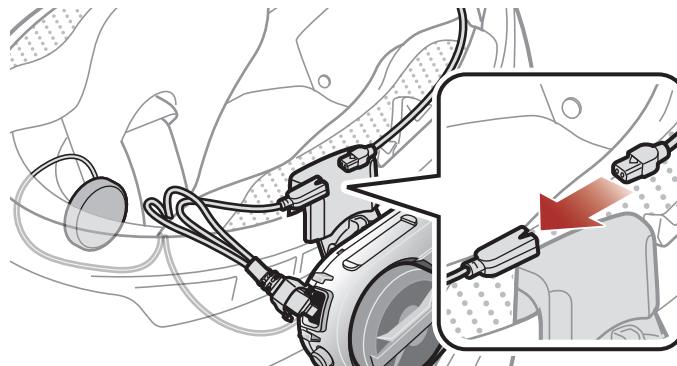

4. Insert the speaker cable into the speaker and microphone port to connect it to the main unit.

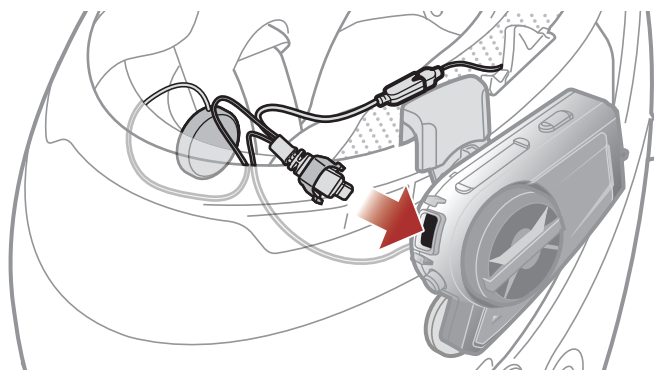

5. Close the cover of the speaker cable to lock the cable to the port.

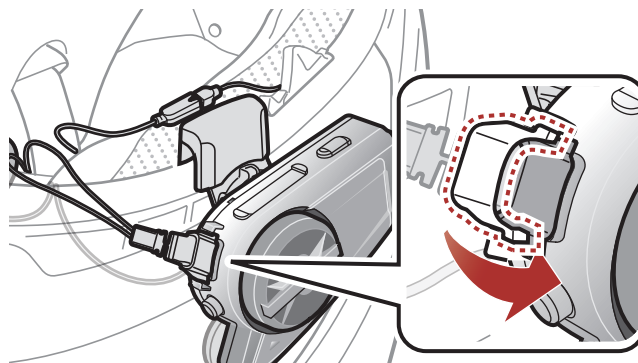

2.4 Adjust the Angle

You can adjust the angle for taking photos or recording videos.

You can rotate the horizontal angle by 30°. Rotate the lever next to the lens to set the desired angle.

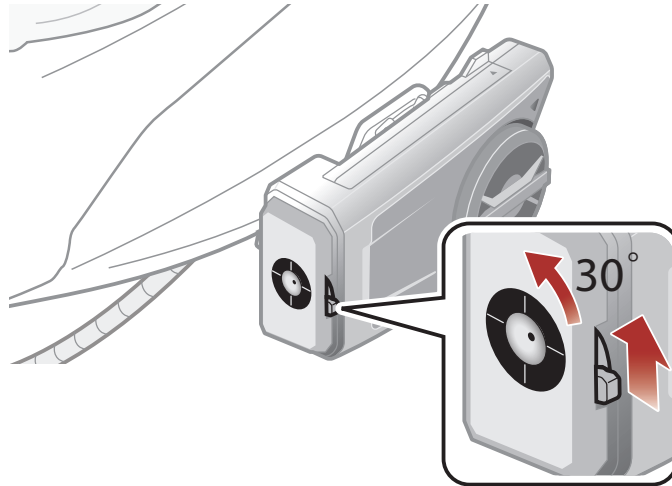

2.4.1 Using the Gear Clamp Unit

You can rotate the vertical angle by 360°. Loosen the wheel next to the main unit and rotate the main unit to set the desired angle. Tighten the wheel to lock it into position.

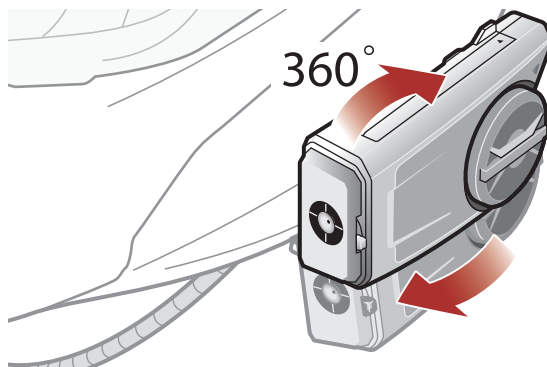

2.4.2 Using the Clamp Unit

You can change the vertical angle by 20° (Default), 8°, or 32°. The vertical angle change shall be made before the clamp is mounted on the helmet.

- Loosen the two screws on the back plate of the clamp unit with the included allen wrench.

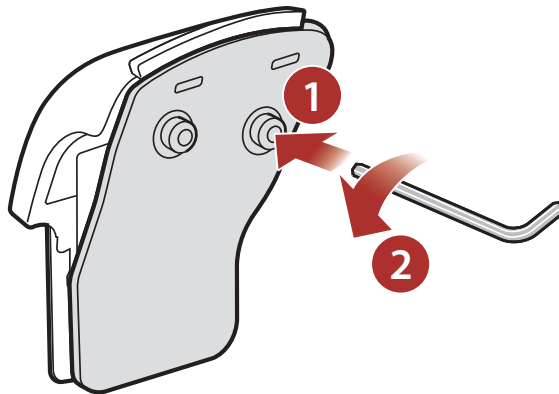

- Remove the angle plate and flip it up and down to make the angle display "8°" visible. The vertical angle is changed to 8°.
- Remove the angle plate and turn it backwards to make the angle display "32°" visible. The vertical angle is changed to 32°.

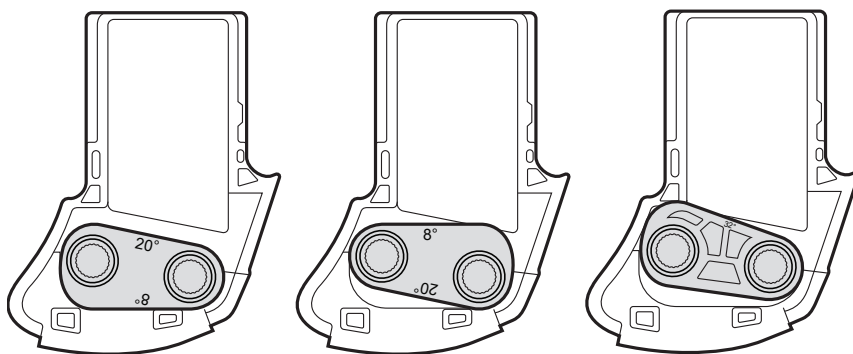

3. BASIC OPERATION

3.1 Charging

Charging the Headset

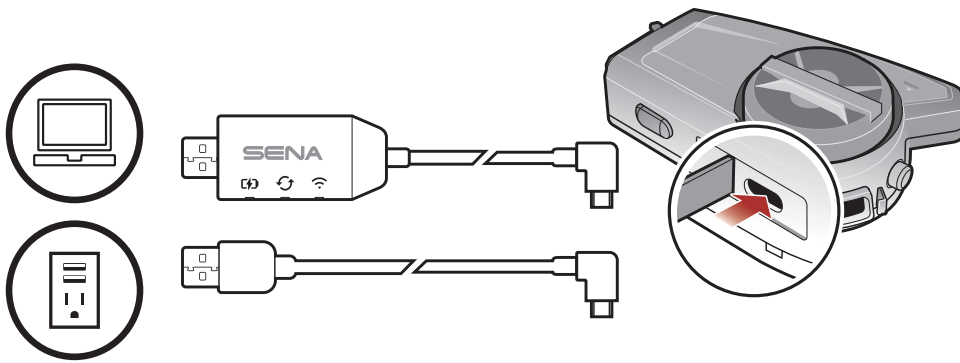

You can charge the headset by connecting the **WiFi Charging Cable** or a **USB Power & data Cable (USB-C)**.

A **USB Power & data Cable (USB-C)** is not included in the package.

The headset will be fully charged in about 2.5 hours. (The charging time may vary depending on the charging method.)



Note:



- Any 3rd party USB charger can be used with Sena products if the charger is approved by either the FCC, CE, IC, or other locally approved agencies.
- Use of a non-approved charger may cause fire, explosion, leakage, and other hazards which may also reduce the life time or performance of the battery.
- **Using When Plugged Into a Power Source (USB-charging adapter or Powerbank)**



When you want to record long videos and time lapse events, connect the **50C** to a power source and then use it.

- If you connect the **50C** to the Powerbank while the camera is on, the **50C** will use the electricity stored in the Powerbank but the battery will not charge.
- If you connect the **50C** to the Powerbank while the camera is off, you can use the **50C** while it charges.

3.2 Legend

 **Tap** Button/Jog Dial the specified number of times
  **Press and Hold** Button/Jog Dial for the specified amount of time



Rotate Jog Dial clockwise (right) or counterclockwise (left).



Rotate while Pressing Jog Dial clockwise (right) or counterclockwise (left).

 *"Hello"* **Audible prompt**

3.3 Powering On and Off

Powering On

 =   



Powering Off

 =   

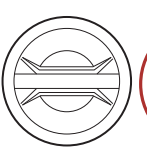

3.4 Volume Adjustment

You can raise or lower the volume by rotating the **Jog Dial** clockwise or counterclockwise. Volume is set and maintained independently at different levels for each audio source (i.e., phone, intercom), even when the headset is rebooted.

Volume Up

 =  

Volume Down

 =  

3.5 Checking the Battery Level

Instructions are for when powering the headset on.

Powering On

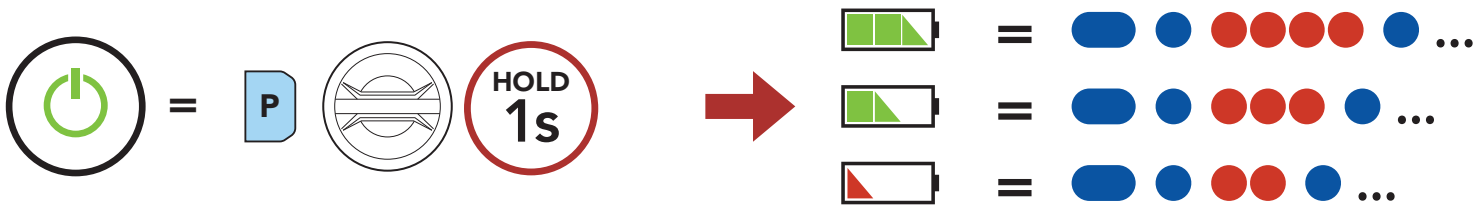

Note: When the battery is low while in use, you will hear a voice prompt saying **“Low battery.”**

3.6 Low Battery Warning

When the battery becomes low, you will hear a voice prompt, **“Camera off, battery low.”** The camera function will shut down soon, but other headset functions such as intercom will still be available for use. Then when the battery becomes very low, the blinking blue LED in stand-by mode turns to red and you will hear a voice prompt, **“Low battery.”** The headset will automatically shut down soon after.

4. CAMERA OPERATION

4.1 Camera On or Off

Camera On







Camera Off



4.2 Camera Modes

You can change the Video Mode setting and Photo Mode setting through the **Sena Camera App**.



Mode	Application	Button
Video	Recode video (normal recording, timelapse, loop recording)	 
Photo	Capture a single photo (Single Shot) or 8 photos (Burst Shot)	 

4.3 Video Recording

Start Recording



Stop Recording



Below is a table of approximate video recording times to microSD card size in specific resolutions and frame rates.

	2160p/30fps	1440p/30fps	1080p/60fps	1080p/30fps
16 GB	33 min	1 h 05 min	1 h 24 min	1 h 52 min
32 GB	1 h 07 min	2 h 11 min	2 h 51 min	3 h 47 min
64 GB	2 h 15 min	4 h 25 min	5 h 44 min	7 h 38 min
128 GB	4 h 30 min	8 h 52 min	11 h 31 min	15 h 20 min

Note:

- microSD cards up to 128 GB are compatible. Using a U3 microSD card is suggested. Your microSD card needs to be formatted using the camera.
- The camera gives a warning and automatically stops recording when the microSD card is full or the battery becomes low.
- The maximum size per video is limited to 4 GB. Therefore, when the video reaches the 4 GB size limit during recording, it saves and creates a new video to continue recording.

4.4 Video Mode (Default: Normal Recording Mode)

4.4.1 Timelapse Video Mode

Timelapse video records series of photos at timed intervals and makes it into a video.

4.4.2 Loop Recording Mode

Loop Recording mode continuously records videos to create footages of assigned length of time (3 minutes). If the memory reaches maximum, then the oldest footage will be deleted to store the most recent footage.

4.5 Taking Photos (Default: Normal Recording Mode)

Take Photos



4.5.1 Single Shot Mode

Single Shot takes 1 photo.

4.5.2 Burst Shot Mode

Burst shot takes 8 photos. Tap the **Camera Button** to take multiple photos.

Note:

- If you are recording in 2160p/30fps of video resolution, you cannot take a photo.
- The camera resolution is fixed to 12MP. However, when you take a photo during video recording, the photo resolution is fixed to 8.3MP.

4.6 Video Tagging

Video Tagging allows the camera to record video continuously, but save only the important events.

It creates video files of past, present, and future with each footage having an assigned length of time (3 minutes).

1. When you encounter an event that is worth saving

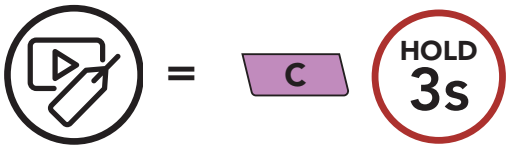

Blinking 3 times 

 "Video tagging"

2. When Video Tagging is complete



 "Tagging complete"

Note:

- Video Tagging can be operated only in the Loop Recording mode. In order for video files of past, present, and future to be saved, Video Tagging must be started at least 3 minutes after Loop Recording starts.
- Video Tagging recorded files are stored in **EVENT folder**.

4.7 Formatting SD Card

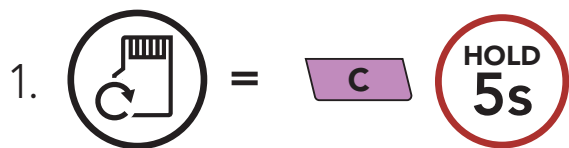

"Format SD card"

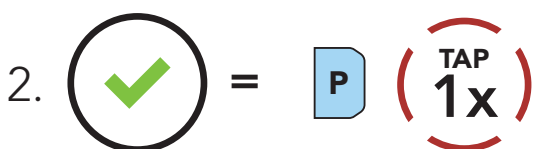

Blinking 



"Format SD card completed"

4.8 Changing the Wi-Fi Channel (Default: 5 GHz)

1.  =   →  "WiFi channel"

2. Select 5 GHz or 2.4 GHz.

• 5 GHz =   → Blinking twice 

• 2.4 GHz =   → Blinking twice 

Note: IF YOUR SMARTPHONE OR REGION DOES NOT SUPPORT 5 GHz, YOU MUST CHANGE THE Wi-Fi CHANNEL TO 2.4 GHz.

5. PAIRING THE HEADSET WITH OTHER BLUETOOTH DEVICES

When using the headset with other Bluetooth devices for the first time, they will need to be “paired.” This enables them to recognize and communicate with one another whenever they are within range.

The headset can pair with multiple Bluetooth devices such as a mobile phone or GPS via **Mobile Phone Pairing**, **Second Mobile Phone Pairing** and **GPS Pairing**. The headset can also be paired with up to three other Sena headsets.

Pairs with up to Three Sena Headsets

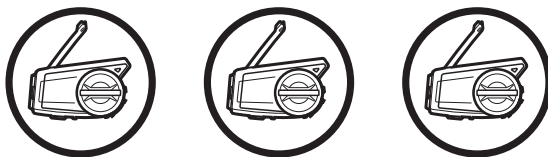

5.1 Phone Pairing

1. Press and hold the **Phone Button** for **5 seconds**.



2. Select **50C** in the list of Bluetooth devices detected. If your mobile phone asks for a PIN, enter 0000.

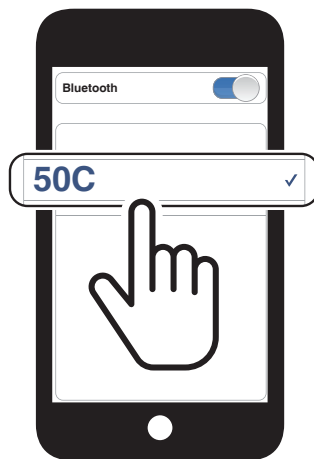

Note: When you turn on the 50C for the first time or reboot it after a factory reset, the 50C will automatically enter phone pairing mode.

5.2 Second Mobile Phone Pairing

1. Press and hold the **Jog Dial** for **5 seconds**.



Blinking 

 "Intercom pairing"

2. Tap the **Phone Button**.

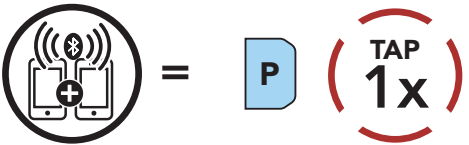

Blinking 

 "Second mobile phone pairing"

3. Select **50C** in the list of Bluetooth devices detected. If your mobile phone asks for a PIN, enter 0000.

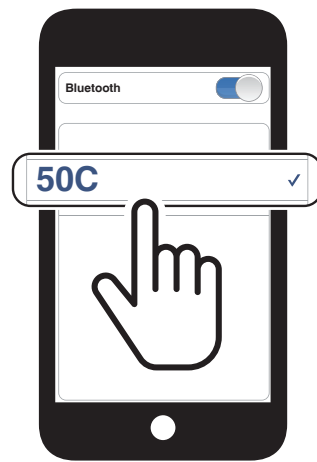

5.3 GPS Pairing

1. Press and hold the **Jog Dial** for **5 seconds**.



Blinking 

 "Intercom pairing"

2. Tap the **Phone Button**.

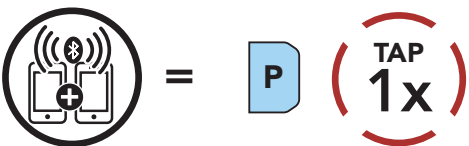

Blinking 

 "Second mobile phone pairing"

3. Tap the **Phone Button**.

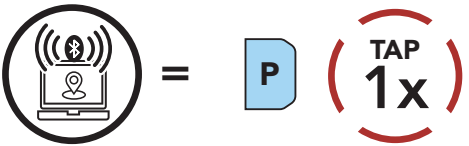

Blinking 

 "GPS pairing"

4. Select **50C** in the list of devices detected. If your Bluetooth device asks for a PIN, enter 0000.



5.4 Advanced Selective Pairing: Hands-Free or A2DP Stereo

Phone Pairing allows the headset to establish two Bluetooth profiles: **Hands-Free** or **A2DP Stereo**. **Advanced Selective Pairing** allows the headset to separate the profiles to enable connection with two devices.

5.4.1 Phone Selective Pairing - Hands-Free Profile

1. Press and hold the **Phone Button** for **5 seconds**.



2. Tap the **Phone Button**.

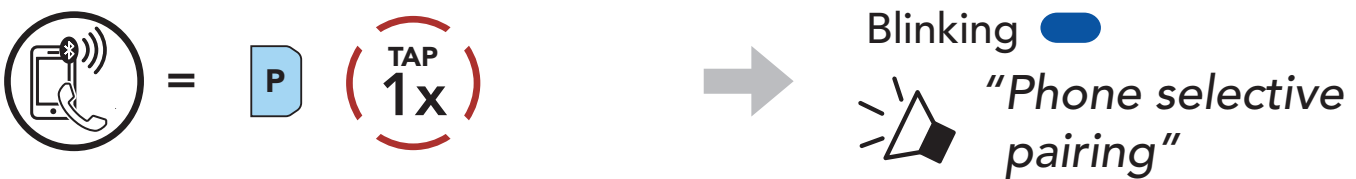

3. Select **50C** in the list of Bluetooth devices detected. If your mobile phone asks for a PIN, enter 0000.

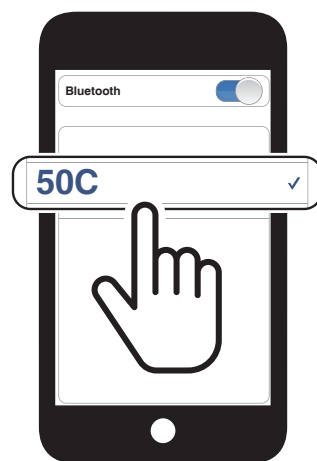

5.4.2 Media Selective Pairing - A2DP Profile

1. Press and hold the **Phone Button** for **5 seconds**.



2. Tap the **Jog Dial**.

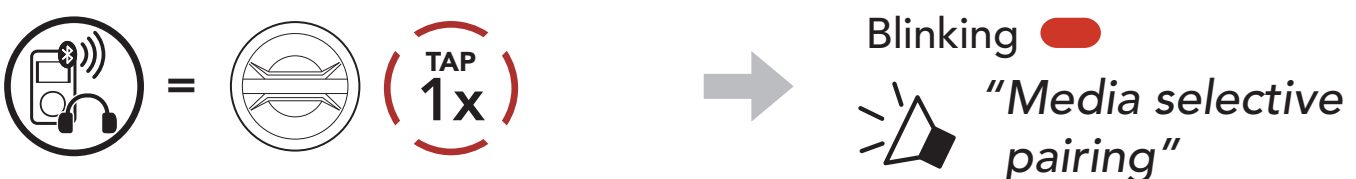

3. Select **50C** in the list of Bluetooth devices detected. If your mobile phone asks for a PIN, enter 0000.

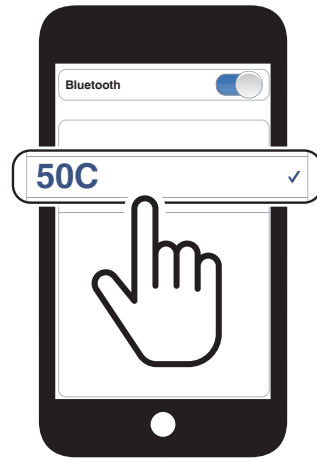

6. MOBILE PHONE USAGE

6.1 Making and Answering Calls

Answer a Call

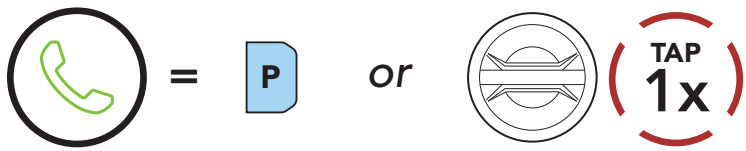

End a Call



Reject a Call

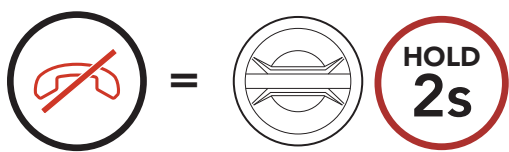

6.2 Siri and Google Assistant

The **50C** supports the **Siri** and **Google Assistant** access directly.

You can activate the **Siri** or **Google Assistant** using the voice through the headset's microphone, a wake word will be used. This is a word or a group of words such as **"Hey Siri"** or **"Hey Google."**

Activate the Siri or Google Assistant Installed on Your Smartphone

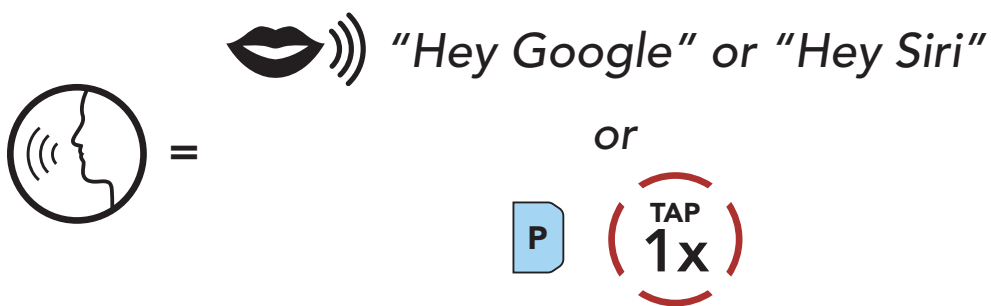

6.3 Speed Dialing

6.3.1 Assigning Speed Dial Presets

Speed Dial Presets could be assigned in the settings menu, accessible through the **Sena Motorcycles App**.

6.3.2 Using Speed Dial Presets

1. Enter into the **Speed Dial** menu.

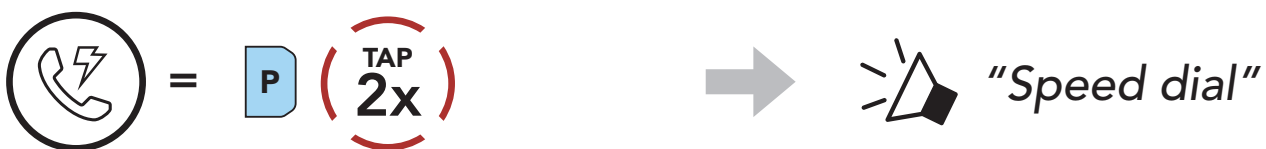

2. Navigate forward or backward through **Speed Dial Preset** numbers.

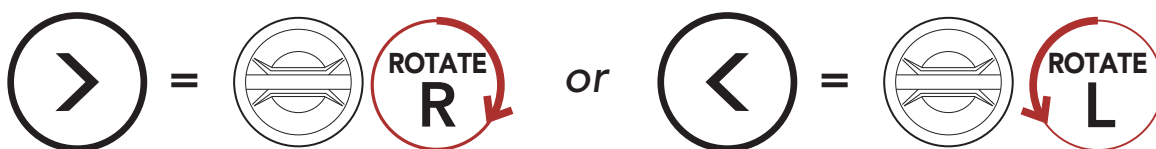

(1) Last number redial

(2) Speed dial 1

(3) Speed dial 2

(4) Speed dial 3

(5) Cancel

3. Call one of your **Speed Dial Presets** numbers.



4. Redial the last number called.



7. STEREO MUSIC

7.1 Playing Music with Bluetooth Devices

Play/Pause Music

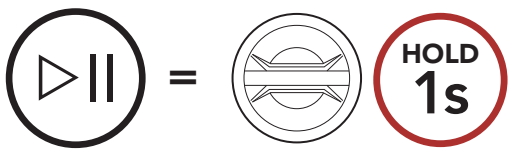

Track Forward/Backward

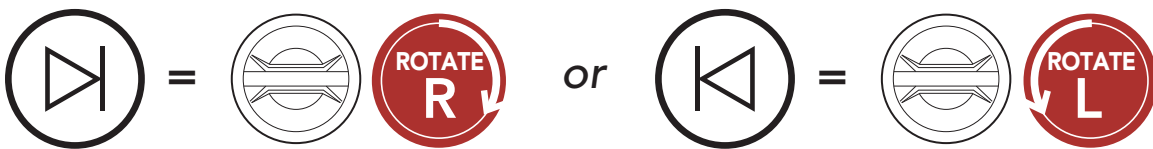

7.2 Music Sharing

You can start sharing music with one intercom friend using Bluetooth stereo music during a **two-way intercom conversation** and **one participant of a Mesh**. If you start sharing music while Bluetooth intercom and Mesh Intercom are running at the same time, then music shared during Bluetooth intercom will take priority over music shared during Mesh Intercom.

Note:

- Both you and your intercom friend can remotely control music playback such as track forward and track back.
- **Music sharing** will be paused when you are using your mobile phone or listening to GPS instructions.
- **Music sharing** will be terminated if the headset starts a multi-way intercom conference.

7.2.1 Bluetooth Intercom Music Sharing

You can start sharing the music with one intercom friend of a **two-way intercom conversation**.

Start Sharing Music



Terminate Sharing Music



7.2.2 Mesh Intercom Music Sharing

You can start sharing music with one participant of a **Mesh Intercom**.

Start Sharing Music

1. The **Creator** will send a request message to **participants** connected during **Mesh Intercom**.

[Creator]

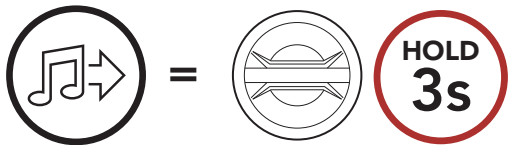

[Creator]



[Participants]

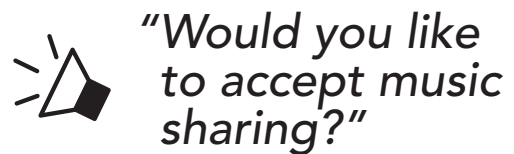

2. The **Creator** will share music with the **first participant** that accepts the request.

[Participant] Accept

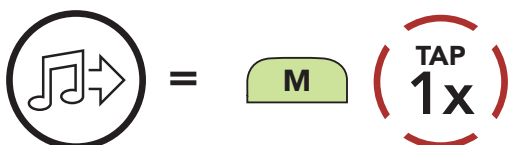

[Participant] Refuse

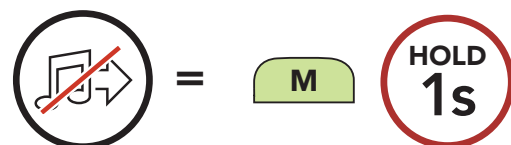

Terminate Sharing Music



8. MESH INTERCOM

8.1 What is Mesh Intercom?

Mesh Intercom is a dynamic communication system created by Sena that provides instant and effortless bike-to-bike communication without a pre-grouping process. **Mesh Intercom** allows users to connect and communicate with nearby users without the need to pair each headset together.

The working distance between each **50C** in **Mesh Intercom** can be up to 1.2 mi (2 km) in open terrain. In open terrain, the **Mesh** can be extended up to 5 mi (8 km) between a minimum of six users.

Users can communicate in two modes:

- Open Mesh™ for open group intercom conversations.
- Group Mesh™ for private group intercom conversations.

Mesh Intercom



8.1.1 Open Mesh

Open Mesh is an open group intercom function. Users can freely communicate with each other in the same **Open Mesh** channel and select which channel (1-9) to use through the headset.

It can connect with a virtually unlimited number of users in each channel.

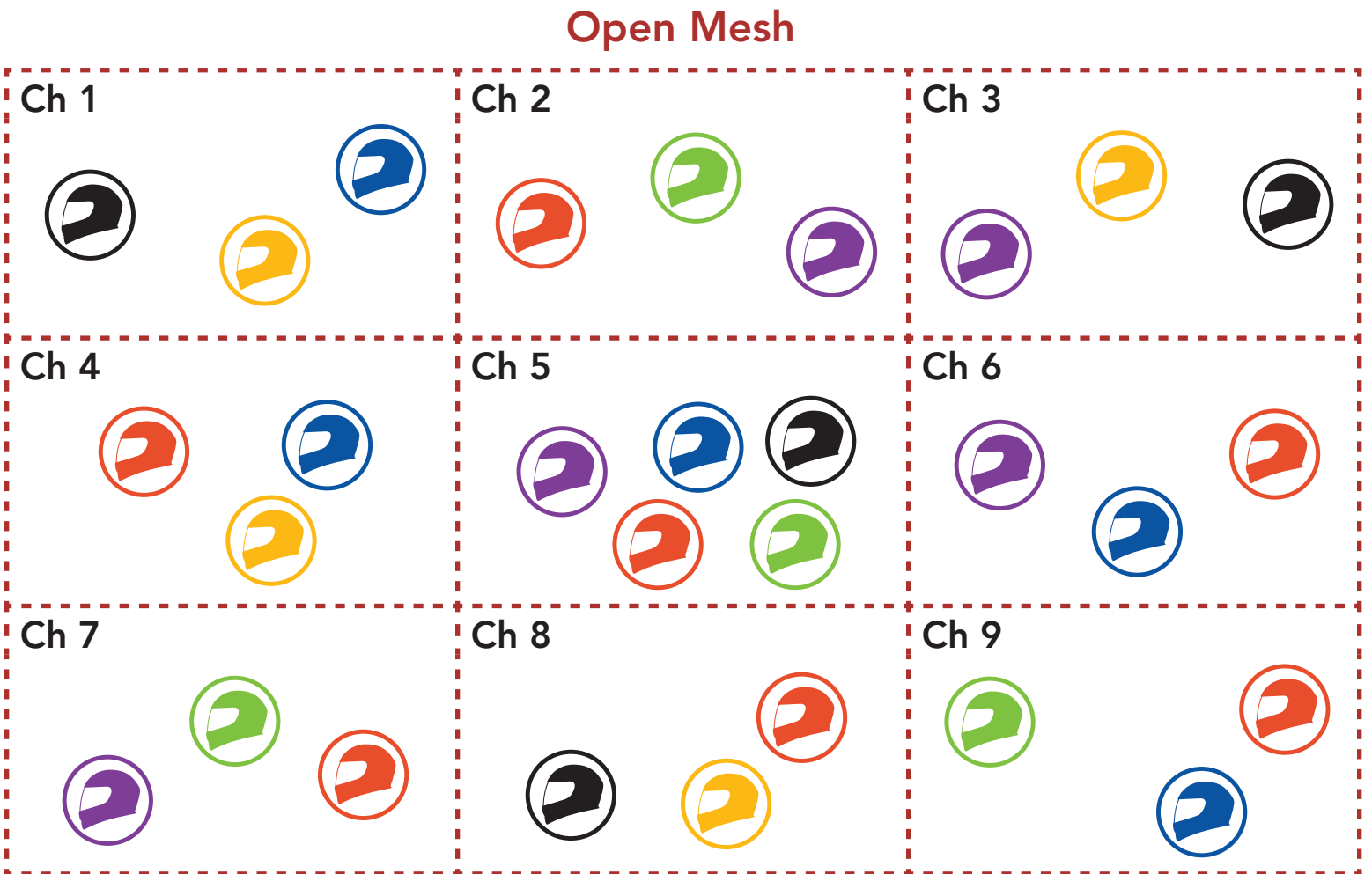

8.1.2 Group Mesh

Group Mesh is a closed group intercom function that allows users to join, leave, or rejoin a group intercom conversation without pairing each headset. Users can freely communicate with each other in the same private group in **Group Mesh**.

For closed intercom conversations using **Mesh Intercom**, a **Group Mesh** needs to be created by the users. When users create a private group in **Group Mesh** by **Mesh Grouping**, the headset automatically switches from **Open Mesh** to **Group Mesh**. Up to 24 users can all be connected in each private group.

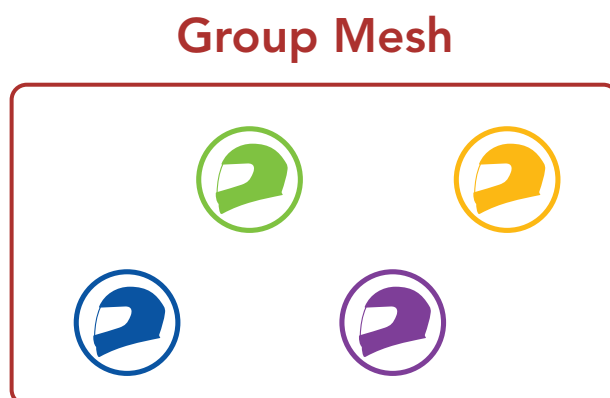

8.2 Starting Mesh Intercom

When **Mesh Intercom** is enabled, the **50C** will automatically connect to nearby **50C** users and allow them to talk to each other.

Mesh Intercom On

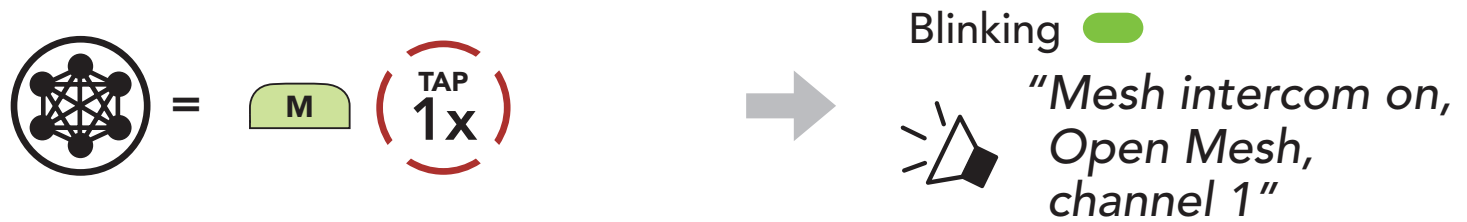

Mesh Intercom Off

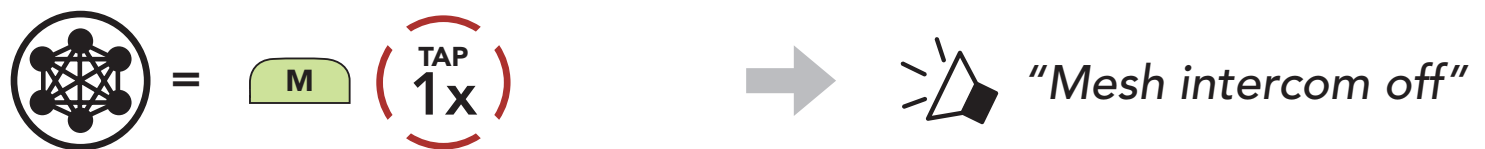

8.3 Using the Mesh in Open Mesh

When **Mesh Intercom** is enabled, the headset will be in **Open Mesh (default: channel 1)** initially.

8.3.1 Channel Setting (Default: channel 1)

If the **Open Mesh** communication experiences interference because other groups are also using **channel 1 (default)**, change the channel. You can select from channels 1 to 9.

1. Double tap the **Mesh Intercom Button**.

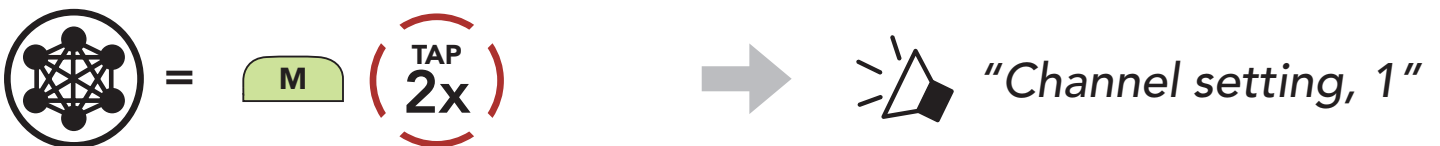

2. Navigate between channels.

(1 → 2 → ... → 8 → 9 → Exit → 1 → ...)

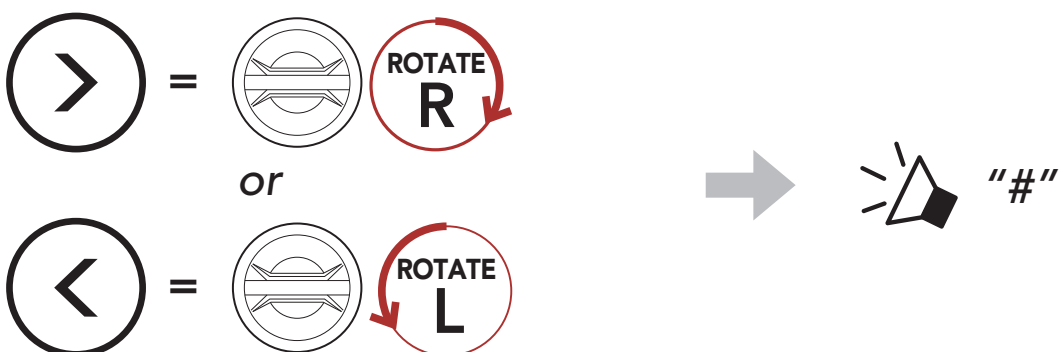

3. Save the channel.



Note:

- **Channel Setting** always starts with channel 1.
- If you do not press any button for approximately **10 seconds** in a specific channel, the channel is automatically saved.
- The channel will be remembered even if you turn off the **50C**.
- You can use the **Sena Motorcycles App** to change the channel.

8.4 Using Mesh in Group Mesh

8.4.1 Creating a Group Mesh

Creating a **Group Mesh** requires **two or more Open Mesh users**.

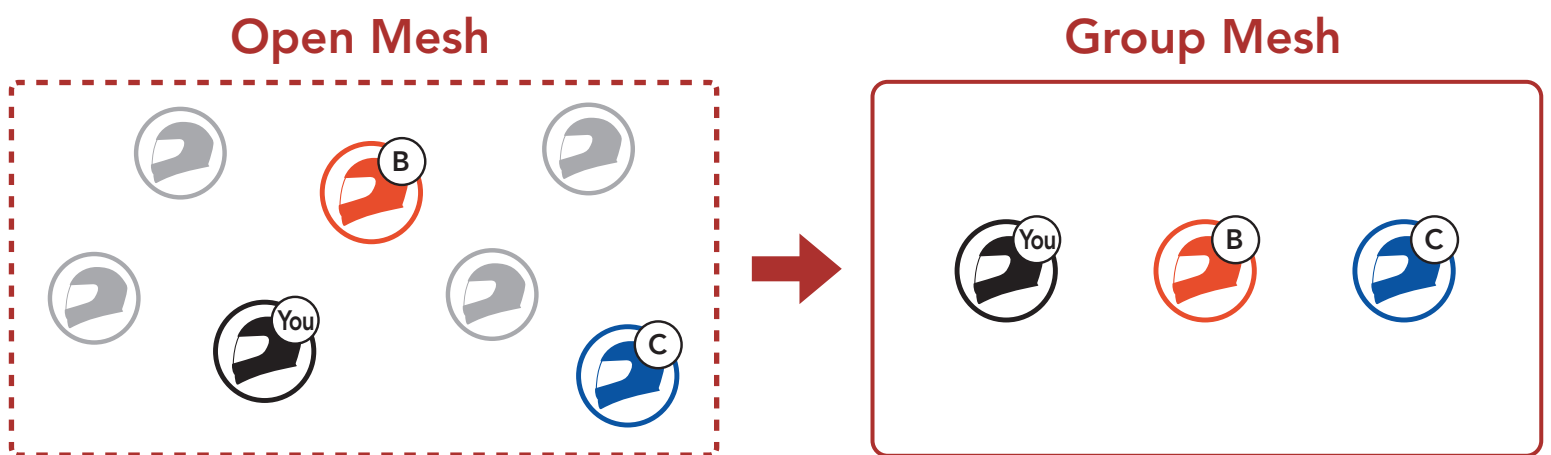

1. To enter **Mesh Grouping** to create a **Group Mesh**, press and hold the **Mesh Intercom Button** for **5 seconds** on the **users' (You, B, and C)** headsets.



2. When **Mesh Grouping** is completed, the **users (You, B and C)** will hear a voice prompt on their headset as **Open Mesh** switches to **Group Mesh**.



Note:

- If the **Mesh Grouping** is not completed within **30 seconds**, users will hear a voice prompt, **"Grouping failed."**
- If you want to cancel during the **Mesh Grouping**, tap the **Mesh Intercom Button**.

8.4.2 Joining an Existing Group Mesh

One of the **current users** in an **Existing Group Mesh** can allow **new users (one or more)** in **Open Mesh** to join the **Existing Group Mesh**.

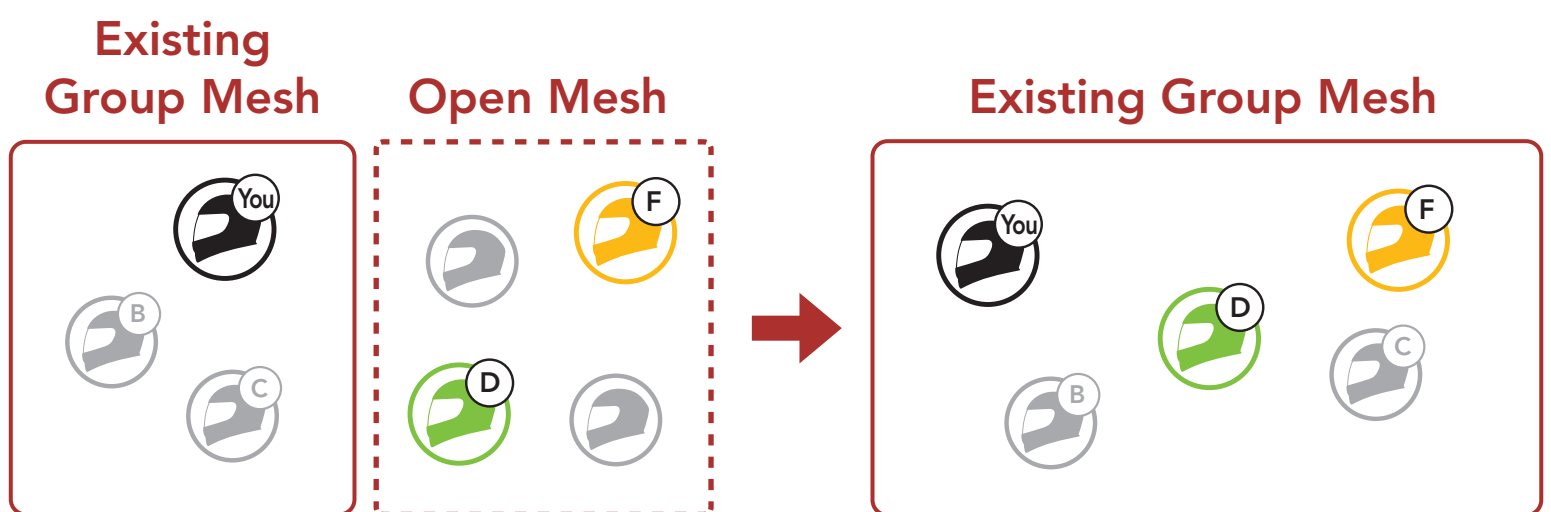

1. To enter **Mesh Grouping** to join the **Existing Group Mesh**, press and hold the **Mesh Intercom Button** for **5 seconds** on the headsets of **one (You) of the current users** in the **Existing Group Mesh** and the **new users (D and F)** in **Open Mesh**.



2. When **Mesh Grouping** is completed, the **new users (D and F)** will hear a voice prompt on their headset as **Open Mesh** switches to **Group Mesh**.



Note: If the **Mesh Grouping** is not completed within **30 seconds**, the current user (You) will hear low-toned double beeps and the new users (D and F) will hear a voice prompt, **"Grouping failed."**

8.5 Enable/Disable Mic (Default: Enable)

Users can enable/disable the microphone when communicating in a **Mesh Intercom**.

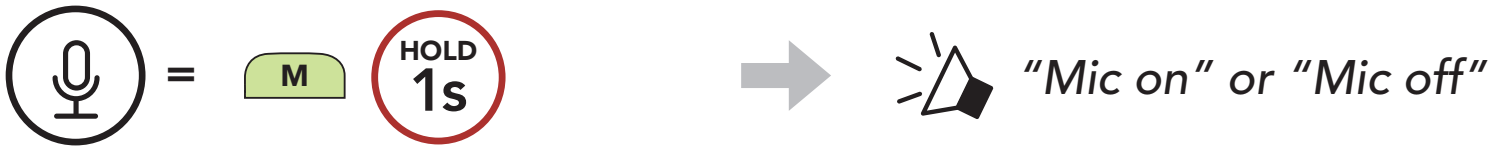

8.6 Toggling Open Mesh/Group Mesh

Users are able to toggle between **Open Mesh** and **Group Mesh** without resetting the **Mesh**. This allows users to keep the **Group Mesh Network** connection information while in **Open Mesh**.

Users can toggle to **Group Mesh** to communicate with participants from the stored **Group Mesh Network** connection information.

Toggle Between Open Mesh and Group Mesh

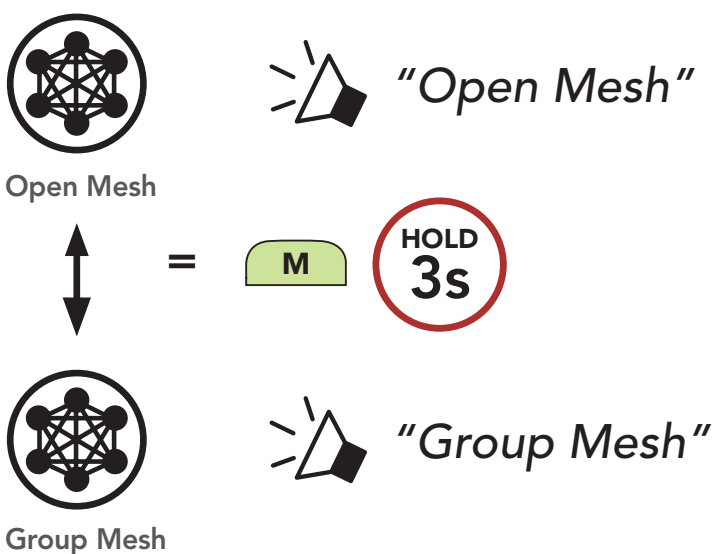

Note: If you have never participated in **Group Mesh**, you cannot toggle between **Open Mesh** and **Group Mesh**. You will hear a voice prompt, "No group available."

8.7 Mesh Reach-Out Request

You (caller) can send a request message to turn on the Mesh Intercom to nearby* friends who have it turned off.

1. If you want to send or receive a request message, you need to enable **Mesh Reach-Out** on the **Sena Motorcycles App**. Please refer to **Section 14.2: "Software Configuration Setting."**
2. While your headset's Mesh Intercom is on, you (caller) send a request message using the **headset's Button** or the **Sena Motorcycles App**.

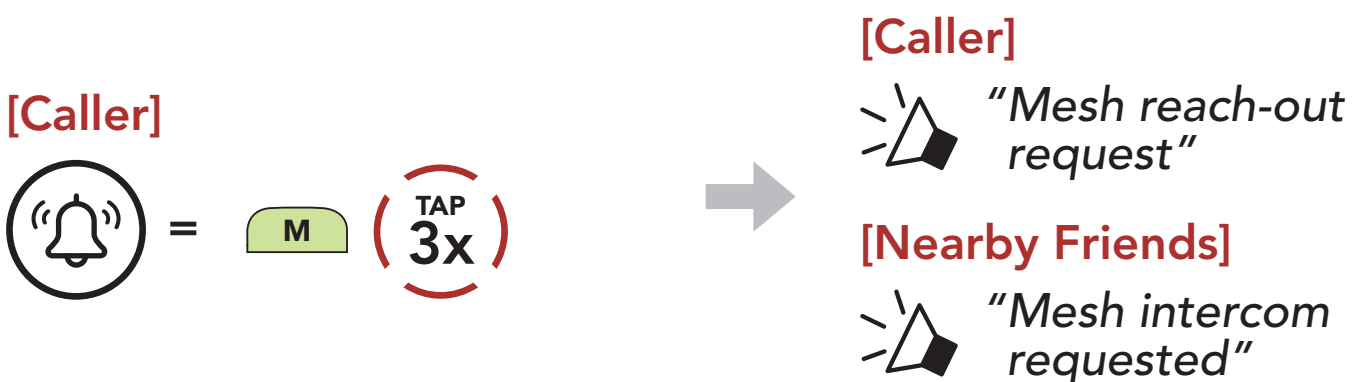

3. Friends who receive the request message need to manually turn on their Mesh Intercom using the **headset's Button** or the **Sena Motorcycles App**.

Note:

- *: Up to 109 yds (100 m) in open terrain
- To use the **Mesh Reach-Out Request** function, **you (caller) who sends a request message and the friends who receive the request message must update the headset to the latest firmware version and the app to the latest version.**

8.8 Reset Mesh

If a headset in an **Open Mesh** or **Group Mesh** resets the **Mesh**, it will automatically return to **Open Mesh (default: channel 1)**.

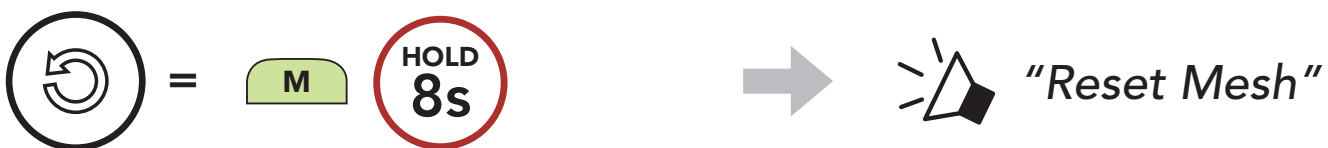

9. BLUETOOTH INTERCOM

Up to three other people can be paired with the headset for Bluetooth intercom conversations.

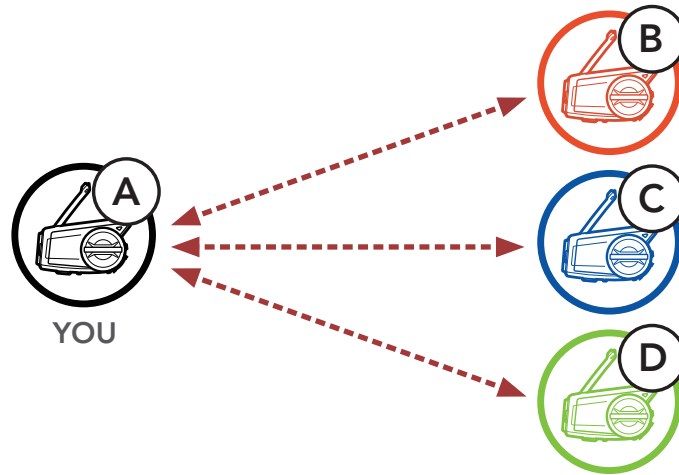



9.1 Intercom Pairing

There are two ways to pair the headset.

9.1.1 Using the Smart Intercom Pairing (SIP)

SIP allows you to quickly pair with your friends for intercom communication by scanning the QR code on the **Sena Motorcycles App** without remembering the button operation.

1. Pair the mobile phone with the headset.
2. Open the **Sena Motorcycles App** and tap  (**Smart Intercom Pairing Menu**).
3. Scan the **QR code** displayed on your friend (**B**)'s mobile phone.
 - Your friend (**B**) can display the QR code on the mobile phone by tapping  > **QR code** () on the **Sena Motorcycles App**.

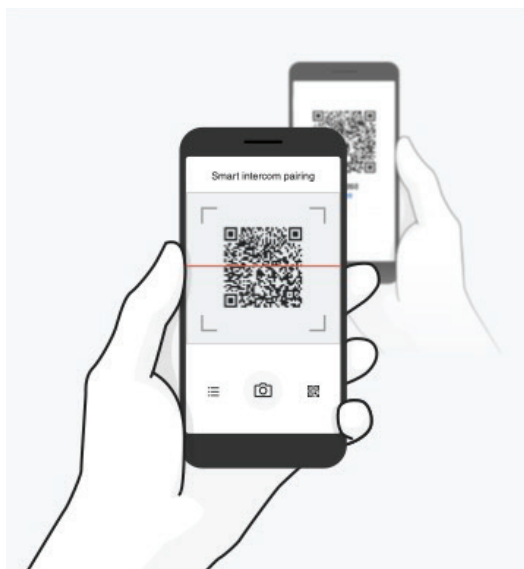

4. Tap **Save** and check that your friend **(B)** is paired with **you (A)** correctly.
5. Tap **Scan** (📷) and repeat steps 3-4 to pair with **Intercom Friends (C)** and **(D)**.

Note: The **Smart Intercom Pairing (SIP)** is not compatible with Sena products that use **Bluetooth 3.0** or **below**.

9.1.2 Using the Button



1. The **users (You, B)** enter into **Intercom Pairing**.



Blinking

"Intercom pairing"

Turns blue

2. The **users' headsets** will be automatically paired.



3. Repeat the steps above to pair with **other headsets (C and D)**.

9.2 Last-Come, First-Served

The intercom pairing queue is **Last-Come, First-Served**. If a headset has multiple paired headsets for intercom conversations, the last paired headset is set as the **First Intercom Friend**. For example, after the pairing procedures listed above, **headset (D)** is the **First Intercom Friend** of headset (A). **Headset (C)** is the **Second Intercom Friend** of headset (A), and **headset (B)** is the **Third Intercom Friend** of headset (A).

Intercom Pairing Order

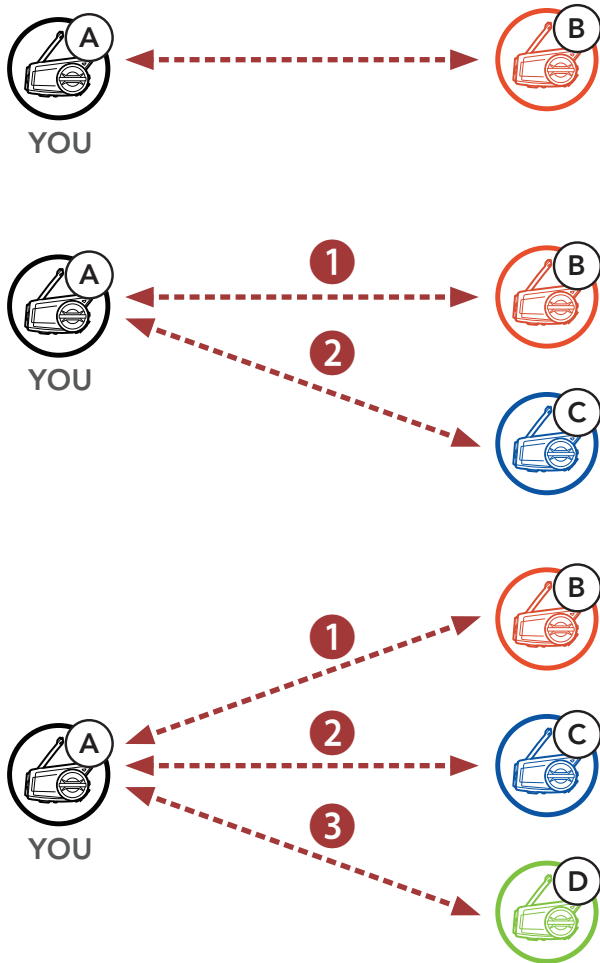

Last-Come, First-Served

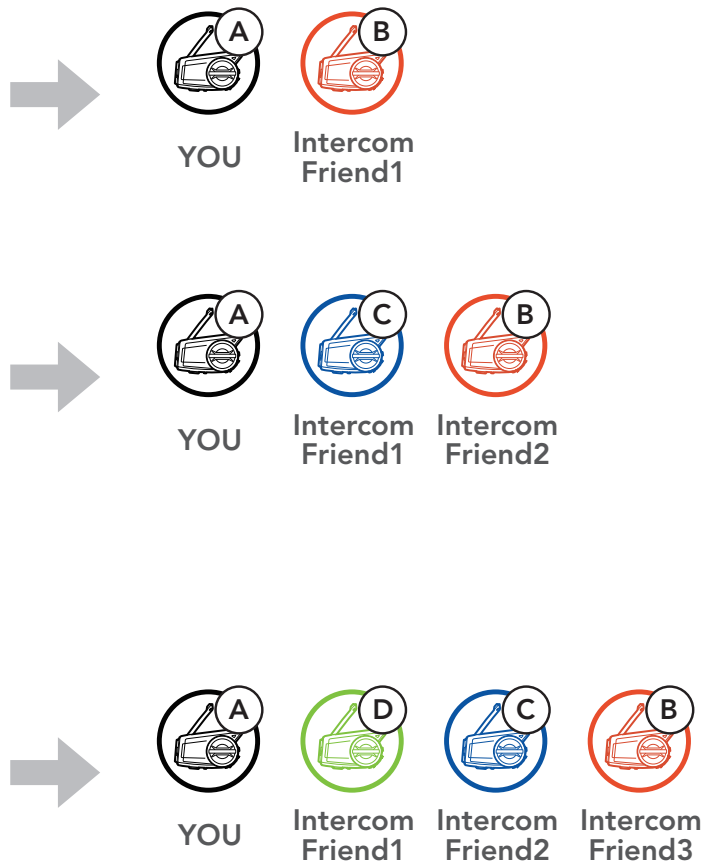

9.3 Two-Way Intercom

You can start or end an intercom conversation with an **Intercom Friend**.

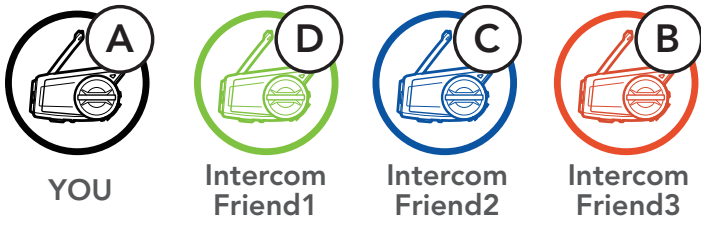

Start/End Conversation with the First Intercom Friend D

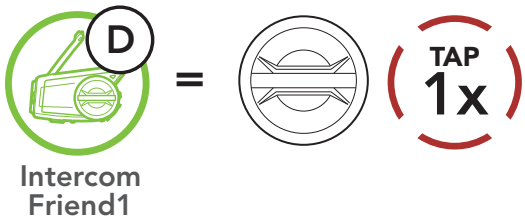

Start/End Conversation with the Second Intercom Friend C

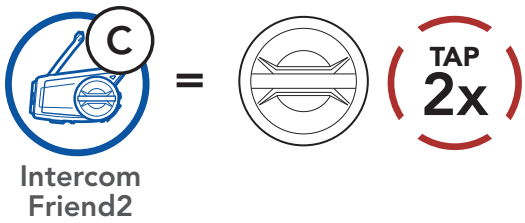

Start/End Conversation with the Third Intercom Friend B

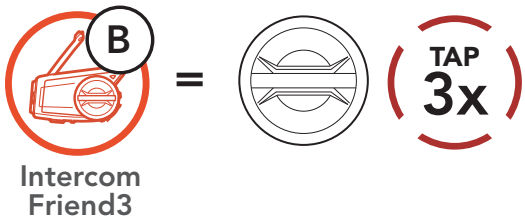

9.4 Multi-Way Intercom

Multi-Way Intercom enables conference-call-style conversations with up to **three Intercom Friends** at the same time. While **Multi-Way Intercom** is in progress, the mobile phone connection is temporarily disconnected. However, as soon as **Multi-Way Intercom** terminates, the mobile phone connection will be reestablished.

9.4.1 Starting a Three-Way Intercom Conference

You (A) can have a **Three-Way Intercom Conference** with two other **Intercom Friends (B and C)** by establishing two intercom connections simultaneously.

- You (A)** need to be paired with two other **Intercom Friends (B and C)** for the **Three-Way Intercom Conference**.



- Start an intercom conversation with the **First Intercom Friend (C)** by tapping the **Jog Dial**.

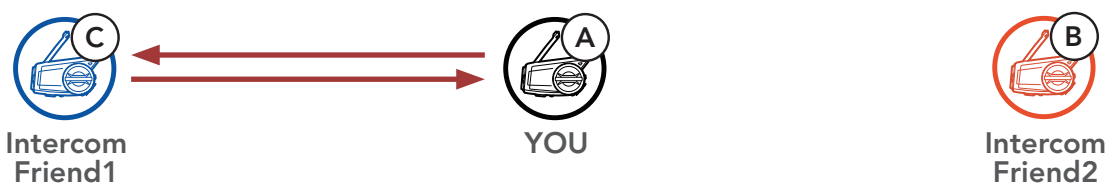

- You (A)** can call the **Second Intercom Friend (B)** by double tapping the **Jog Dial**, or the **Second Intercom Friend (B)** may join the intercom by making an intercom call to **you (A)**.

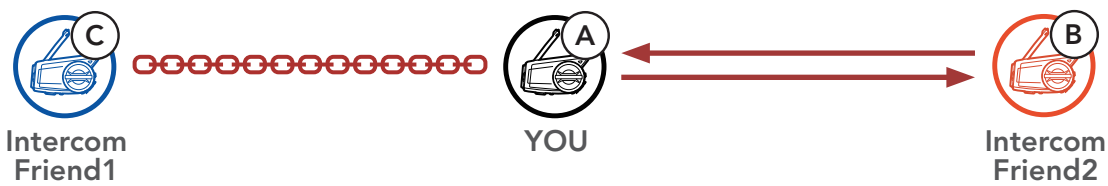

- Now **you (A)** and **two Intercom Friends (B and C)** are having a **Three-Way Intercom Conference**.



9.4.2 Starting a Four-Way Intercom Conference

With **three Intercom Friends** connected, a new participant (**D**) can make it a **Four-Way Intercom Conference** by making an intercom call to either (**B**) or (**C**).

1. **Intercom friend (B)** needs to be paired with a **new participant (D)**.



2. **Intercom friend (B)** can call a **new participant (D)** by tapping the **Jog Dial**, or a **new participant (D)** may join the intercom by making an intercom call to **Intercom friend (B)**.



3. Now **you (A)**, **two Intercom Friends (B and C)**, and a **new participant (D)** are having a **Four-Way Intercom Conference**.



9.4.3 Ending Multi-Way Intercom

You can completely terminate the conference intercom or just disconnect an intercom connection with one of your active **Intercom Friends**.

Terminate All Intercom Connections

- Press and hold the **Jog Dial** for **1 second**.

Disconnect the Intercom Connection with One of the Intercom Friends

- Disconnect (C): Tap the **Jog Dial**.
- Disconnect (B) & (D): Double tap the **Jog Dial**.

Note: When you disconnect the **second friend (B)**, you will be disconnected with the **third participant (D)** as well. This is because the **third participant (D)** is connected with you via the **second friend (B)**.

9.5 Three-Way Conference Phone Call with Intercom Users

You can have a **Three-Way Conference Phone Call** by adding an **Intercom Friend** to the mobile phone conversation.

1. During a mobile phone call, tap the **Jog Dial once, twice or, three times** to invite one of your **Intercom Friends** to the conversation.

Invite an Intercom Friend into Phone Conference

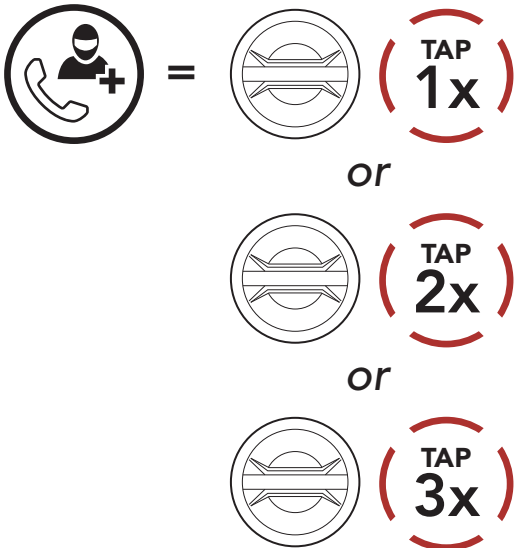

2. To disconnect the intercom during a conference phone call, tap the **Jog Dial once, twice or three times**.

Disconnect an Intercom Friend from Conference

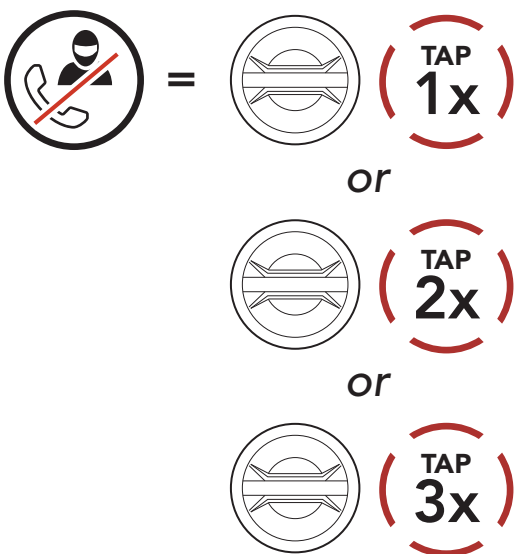

3. To disconnect the mobile phone call during a conference phone call, tap the **Phone Button**.

End Phone Call from Conference

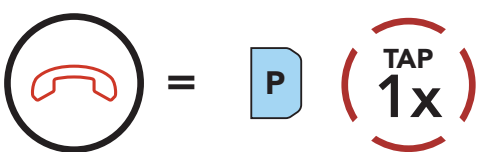

Note: When you have an incoming intercom call during a mobile phone call, you will hear high-toned double beeps.

9.6 Group Intercom

Group Intercom allows you to instantly create a **Multi-Way Conference Intercom** with three of the most recently paired headsets.

To Start the Group Intercom

1. Go through intercom pairing with up to three headsets you want to have **Group Intercom** with.

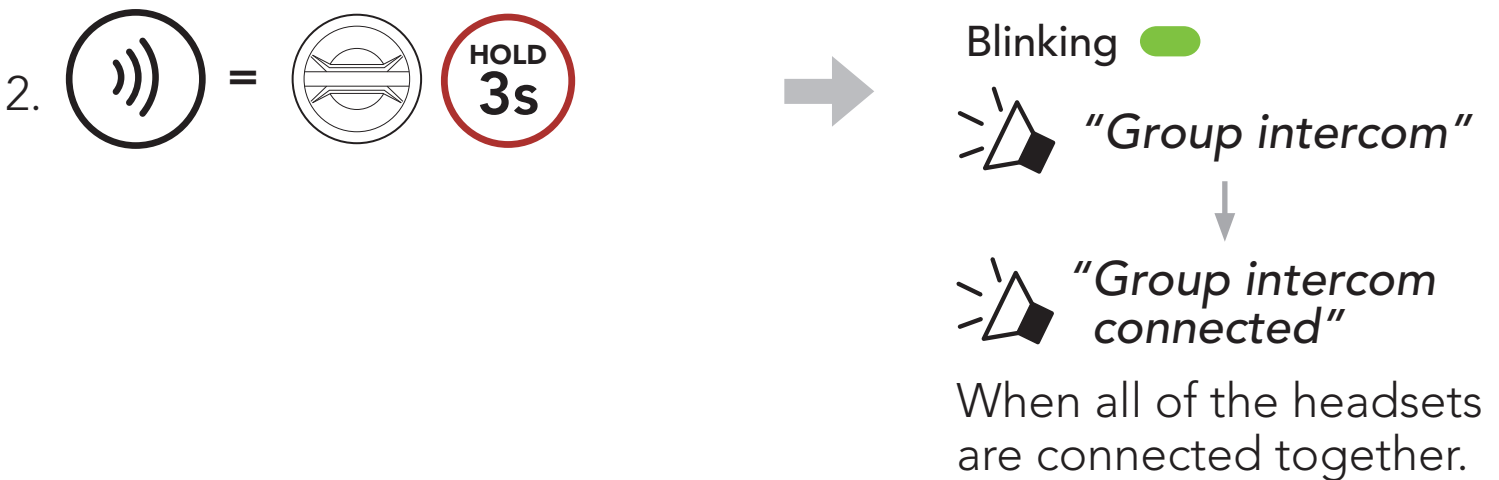

Terminate Group Intercom



9.7 Mesh Intercom Conference with Bluetooth Intercom Participant

Users can use the existing Bluetooth intercom and **Mesh Intercom** function at the same time. In this case, it is recommended to communicate with other Sena headsets via Bluetooth intercom connection and use **Mesh Intercom** between **50C** headsets. A user who is in **Open Mesh** or **Group Mesh** when using Mesh Intercom is able to include up to 3 of their Bluetooth intercom friends. You can start a Two-Way Intercom conversation with one of your three Intercom Friends to include them in the Mesh.

Note:

- The audio quality will be reduced if a **50C** connects to 2 or more Bluetooth intercom friends while in **Open Mesh** or **Group Mesh** when using **Mesh Intercom**.
- If a closed loop is created, as shown below, each user will experience severe noise issues. Sena recommends that a closed loop not be created.

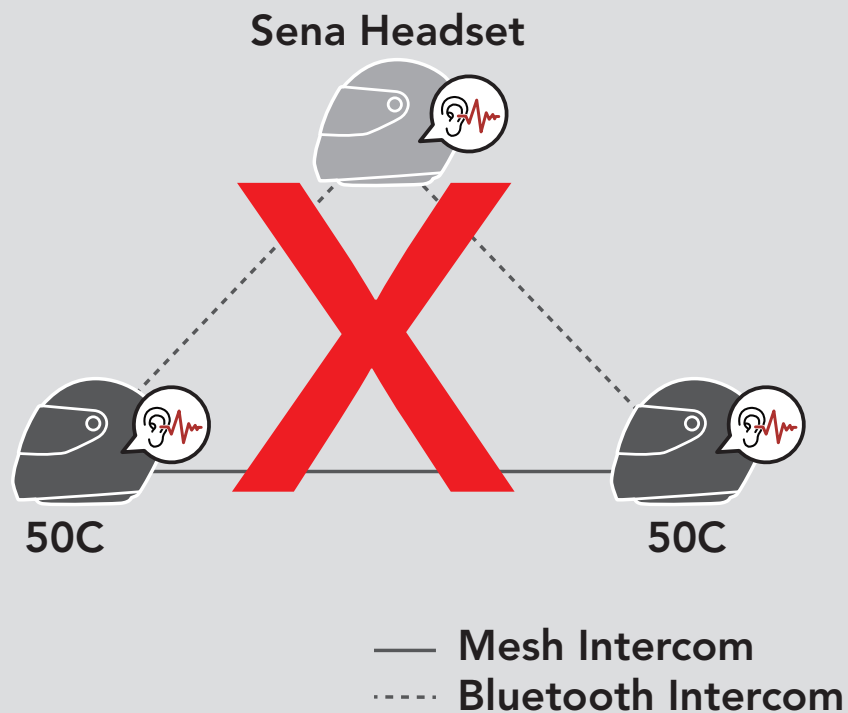



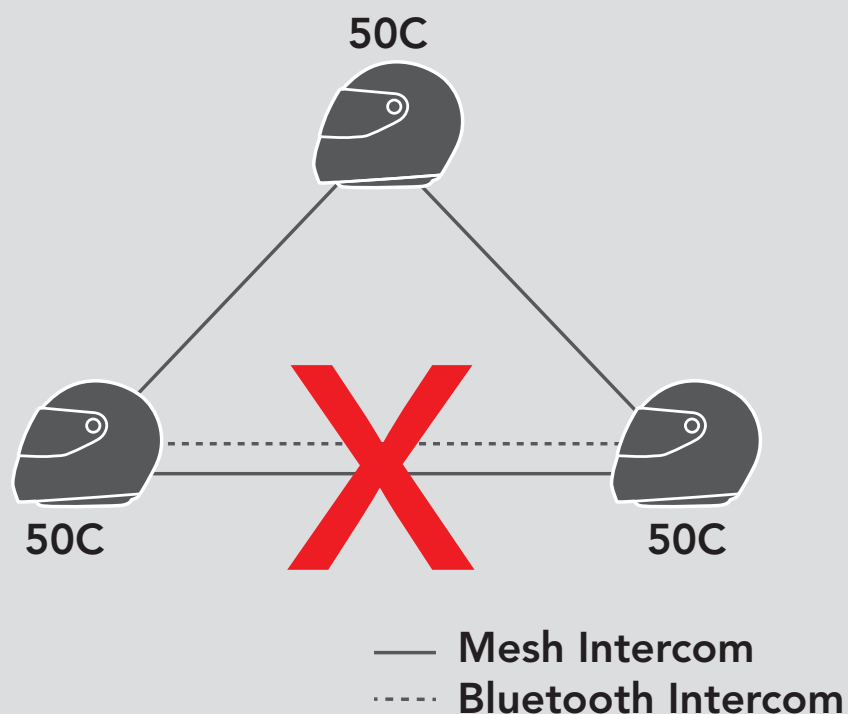







- If **Bluetooth intercom** is accidentally turned on during **Mesh Intercom** communication between **50C** headsets, as shown below, you will hear a voice prompt, "**Mesh intercom disabled. Bluetooth intercom connected**" every **1 minute**. If you turn off the **Bluetooth Intercom** or turn off the **Mesh Intercom**, the voice prompt will no longer come out.



10. UNIVERSAL INTERCOM

Universal Intercom allows you to have intercom conversations with users of non-Sena Bluetooth headsets. Non-Sena Bluetooth headset can be connected to the Sena headset if they support the **Bluetooth Hands-Free Profile (HFP)**. You can pair the headset with only one non-Sena headset at a time. The intercom distance depends on the performance of the Bluetooth headset to which it's connected. When a non-Sena Bluetooth headset is paired with the headset while another Bluetooth device is paired via **Second Mobile Phone Pairing**, it will be disconnected.

10.1 Universal Intercom Pairing

1.  =   →  "Configuration menu"
2.  =   →  "Universal intercom pairing"
3.  =   → Enter into **Universal Intercom Pairing** mode.

4. Put the non-Sena Bluetooth headset in Hands-free Pairing Mode. The headset will automatically pair with a non-Sena Bluetooth headset.

10.2 Two-Way Universal Intercom

You can initiate the **Universal Intercom** connection with non-Sena Bluetooth headsets using the same intercom connection method as you would between other Sena headsets.

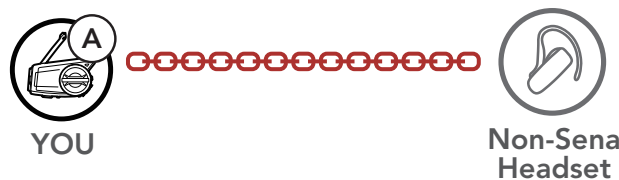

You may start/end a **Two-Way Universal Intercom** using the same way as you do in a normal **Two-Way Intercom**. Please refer to **Section 9.3: "Two-Way Intercom."**

10.3 Multi-Way Universal Intercom

You can have **Multi-Way Intercom** communication with up to **three Intercom Friends** using non-Sena headsets. Some non-Sena headsets may not support **Multi-Way Universal Intercom**.

You may make the **Multi-Way Universal Intercom** call the same way as a normal four-way intercom call.

You may start/end a **Multi-Way Universal Intercom** using the same way as you do in a normal **Multi-Way Intercom**. Please refer to **Section 9.4: "Multi-Way Intercom."**

10.3.1 Three-Way Universal Intercom

You may make a **Three-Way Universal Intercom** connection with two headsets and one non-Sena Bluetooth headset. If the intercom connection is made, all headsets connected cannot use the mobile phone call function since the connection between the headset and the phone is disconnected temporarily. If you disconnect the intercom call, the mobile phone connection is made again automatically so that you can use a mobile phone call function.

1. **You (A)** need to be paired with a non-Sena Bluetooth headset (**B**) and another headset (**C**) for the **Three-Way Conference Intercom**.

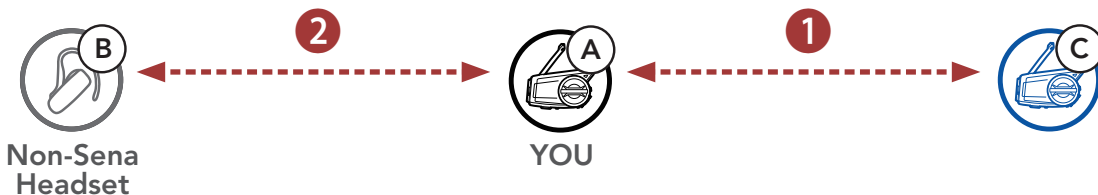

2. Start an intercom conversation with a non-Sena Bluetooth headset (**B**) in your intercom group. For example, **you (A)** may start an intercom conversation with non-Sena Bluetooth headset (**B**). The non-Sena Bluetooth headset (**B**) may also start an intercom call with **you (A)**.

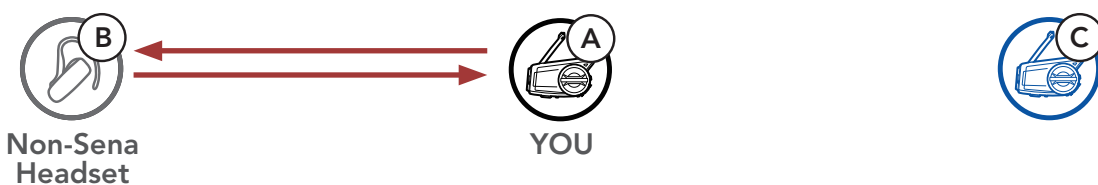

3. The other headset (**C**) may join the intercom by making an intercom call to **you (A)**.

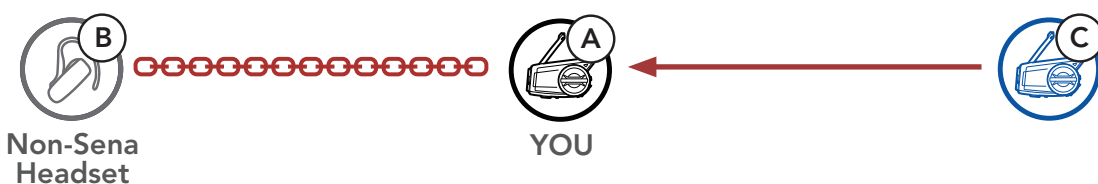

4. Now **you (A)**, non-Sena Bluetooth headset (**B**), and the other headset (**C**) are having a **Three-Way Conference Intercom**.



10.3.2 Four-Way Universal Intercom

You may make the **Four-Way Universal Intercom** call the same way as a normal **Four-Way Intercom** call.

You may make a **Four-Way Universal Intercom** connection with a couple of different configurations,

- 1) two headsets and two non-Sena Bluetooth headsets or
- 2) three headsets and one non-Sena Bluetooth headset.

Four-Way Universal Intercom Case 1

1) **You (A)**, a non-Sena Bluetooth headset (**B**), another headset (**C**), and a non-Sena Bluetooth headset (**D**).

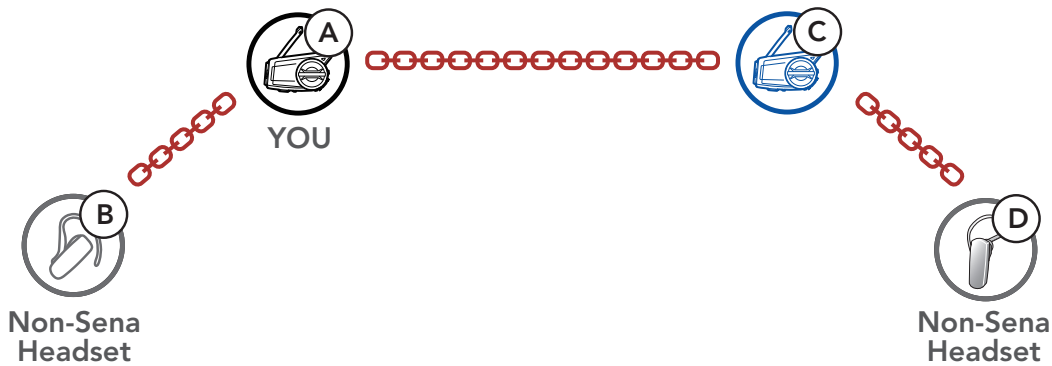

Four-Way Universal Intercom Case 2

2) **You (A)**, a non-Sena Bluetooth headset (**B**), and **two other headsets (C and D)**.

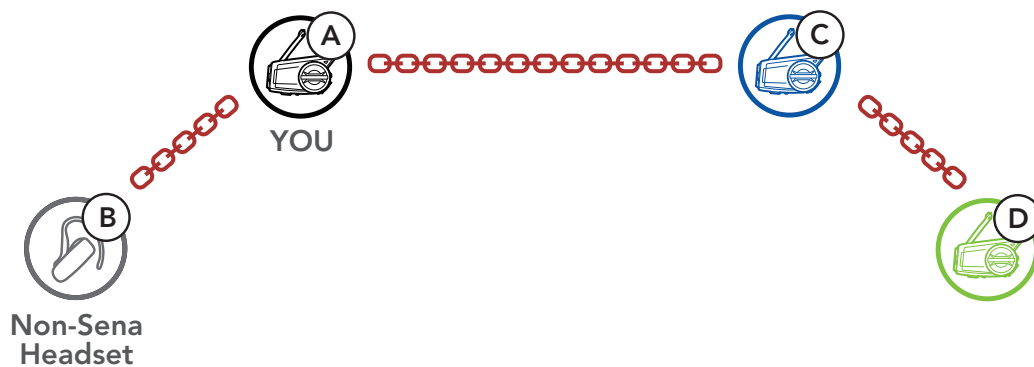

10.4 Mesh Intercom Conference with Two-way Universal Intercom Participant

Users can use the existing **Two-way Universal Intercom** and **Mesh Intercom** function at the same time. In this case, it is recommended to communicate with **non-Sena headset** via **Two-way Universal Intercom** connection and use **Mesh Intercom** between **50C headsets**.

A user who is in **Open Mesh** or **Group Mesh** when using **Mesh Intercom** is able to include one **Universal Intercom friend**. You can start a **Two-way Universal Intercom** conversation with your **Universal Intercom Friend** to include it in the **Mesh**.

11. USING THE FM RADIO

11.1 FM Radio On/Off

FM Radio On



FM Radio Off



11.2 Seek and Save Radio Stations

The **"Seek"** feature searches for radio stations.

1. Search for radio stations.

Seek Stations Forward

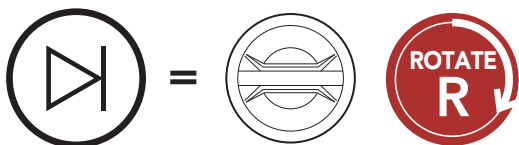

Seek Stations Backward

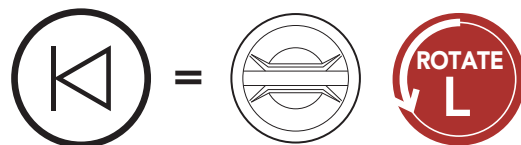

2. Save the current station.

Enter Preset Selection Mode



3. Navigate through the preset numbers that you want to store.

Navigate Forward/Backward Through Preset Stations

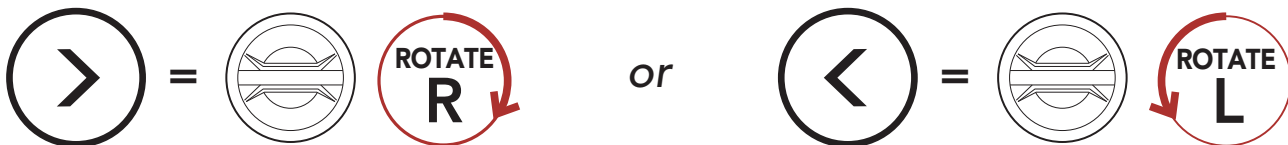

4. Save the station in the preset number you choose or delete the station from memory.

Save Station to the Preset Number



Delete Station from Memory

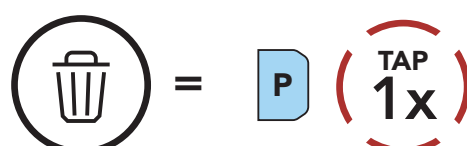

11.3 Scan and Save Radio Stations

The **“Scan”** function automatically searches for radio stations, starting with the current station’s frequency, then up from there.

1. Scan for stations.

Start Scanning

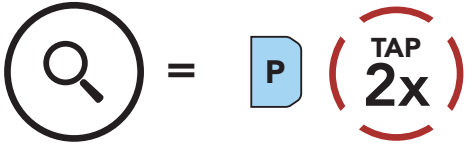

2. The Sena tuner pauses at each station it finds for **8 seconds** before moving to the next.
3. Save the current station. The station will be saved as the next preset number.

Save the Current Station



4. Stop scanning.

Stop scanning

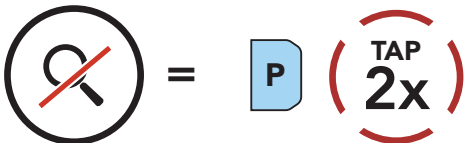

Note: You can use the **Sena Motorcycles App** to save the preset stations.

11.4 Temporary Station Preset

The **Temporary Preset** feature automatically finds and saves the nearest 10 radio stations without changing your existing preset stations.

1. Automatically find and save 10 stations.

Temporary Stations

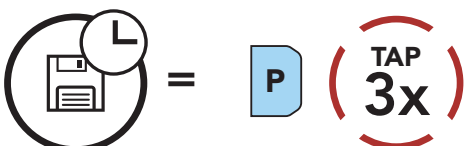

2. The temporary preset stations will be cleared when the headset reboots.

11.5 Navigating Preset Stations

Using the methods above, up to 10 radio stations can be stored. You can navigate through the saved stations.

Navigate through Preset Stations

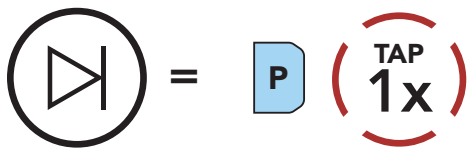

12. VOICE COMMAND

The **Voice Command** of the headset allows you to operate certain operations by simply using your voice. You can control the headset completely hands-free using the voice recognition. Multi-language Voice Command supports **English, French, German, Spanish, Italian, Chinese, Japanese, and Russian.**

Speak a Voice Command List

Mode Status	Function	Voice Command
Standby/ Bluetooth Intercom/ Mesh Intercom/ FM Radio/ Music	Check battery	"Hey Sena, Check Battery"
	Volume Up	"Hey Sena, Volume Up"
	Volume Down	"Hey Sena, Volume Down"
	Phone Pairing	"Hey Sena, Phone Pairing"
	Bluetooth Intercom Pairing	"Hey Sena, Pairing Intercom"
	Start/End each Bluetooth Intercom	"Hey Sena, Intercom [One, Two, Three]"
	Turn on Camera	"Hey Sena, Camera On"
	Turn off Camera	"Hey Sena, Camera Off"
	Start Recording	"Hey Sena, Recording"
	Stop Recording	"Hey Sena, Stop Recording"
	Start Video Tagging	"Hey Sena, Tag Video"
Standby/ Bluetooth Intercom/ FM Radio/ Music	Turn on Mesh Intercom	"Hey Sena, Mesh On"
Mesh Intercom	Turn off Mesh Intercom	"Hey Sena, Mesh Off"
	Mesh Grouping	"Hey Sena, Mesh Grouping"
	Switch to Open Mesh	"Hey Sena, Open Mesh"
	Switch to Group Mesh	"Hey Sena, Group Mesh"
	End the Bluetooth intercom and Mesh intercom	"Hey Sena, End Intercom"
Standby/ Bluetooth Intercom/ Mesh Intercom	Play Music	"Hey Sena, Play Music"

Mode Status	Function	Voice Command
Standby/ Intercom/ Mesh Intercom/ Music	Turn on FM radio	"Hey Sena, FM Radio On"
Music/ FM Radio	<ul style="list-style-type: none"> • FM - Next Preset • Music - Next Track 	"Hey Sena, Next"
	<ul style="list-style-type: none"> • FM - Previous Preset • Music - Previous Track 	"Hey Sena, Previous"
Music	Pause Music	"Hey Sena, Stop Music"
FM Radio	Turn off FM Radio	"Hey Sena, FM Radio Off"
Answer an Incoming Call		"Answer"
Ignore an Incoming Call		"Ignore"

Note:

- You can set a language to another language by using the **Language** feature on the **Sena Motorcycles App**.
- If you set a language that does not support voice commands, the voice command will work only with English commands.
- You can see the another language's voice command list on the **Sena Motorcycles App**.
- **Voice command** performance may vary based on the environmental conditions. To improve the performance, minimize wind noise on the microphone by using a large microphone sponge and closing the visor.

13. FUNCTION PRIORITY AND FIRMWARE UPDATE

13.1 Function Priority

- (highest)** Mobile phone
Mesh Intercom/Bluetooth Intercom
Music sharing via Bluetooth stereo music
FM radio
- (lowest)** Bluetooth stereo music

A lower-priority function gets interrupted by a higher-priority function. For example, stereo music will be interrupted by an **Intercom Conversation**; an **Intercom Conversation** will be interrupted by an incoming mobile phone call.

13.2 Firmware Update

13.2.1 WiFi Charging Cable

You can update firmware using the **WiFi Charging Cable**. You can automatically install any available firmware updates to your headset via your wireless network. Please refer to the **WiFi Charging Cable User Guide**.

13.2.2 50 Series Updater Software for Windows PC or Mac

You can update firmware using the **50 Series Updater Software**. The **USB Power & Data Cable (USB-C)** must be connected to your PC or Mac to update firmware using the **50 Series Updater Software**.

Note:

- A **USB Power & Data Cable (USB-C)** is not included in the package.
- Do not connect the **WiFi Charging Cable** to your PC or Mac to use the **50 Series Updater Software**.

14. CONFIGURATION SETTING

14.1 Headset Configuration Menu

Access the Configuration Menu

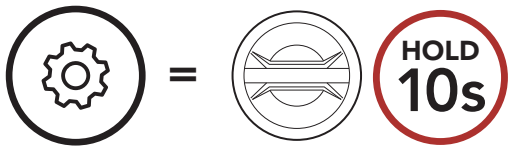

Navigate Between Menu Options

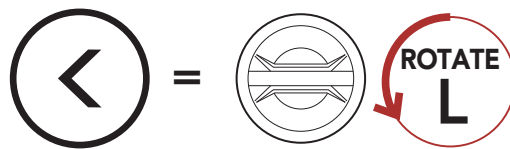
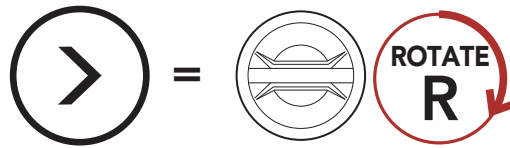

Execute Menu Options

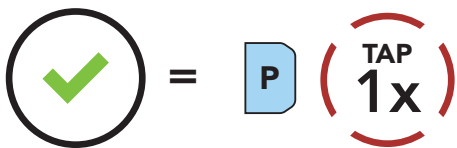

Headset Configuration Menu

Voice Configuration Menu	Tap the Phone Button
Delete All Pairings	Execute
Remote Control Pairing	Execute
Universal Intercom Pairing	Execute
Exit	Execute

14.1.1 Delete All Pairings

You can delete all Bluetooth pairing information of the headset.

14.1.2 Remote Control Pairing

You can remotely control the headset using **Sena Remote Control devices** (sold separately).

1. Turn on the headset and the Remote Control device.
2. Execute **Remote Control Pairing**.
3. Enter pairing mode in the Remote Control device. The headset will automatically connect with the Remote Control device in pairing mode.

14.2 Software Configuration Setting

You can change the settings of the headset through the **Sena Motorcycles App**.

14.2.1 Language

You can select the device language. The selected language is maintained even when the headset is rebooted.

14.2.2 Mesh Reach-Out (Default: Disable)

When the **Mesh Reach-Out** is enabled, a Mesh Reach-Out request message can be sent or received. If the **Mesh Reach-Out** is disabled, a Mesh Reach-Out request message cannot be sent or received.

14.2.3 Equalizer (Default: Music Balance)

Increase or decrease the decibel level of different frequency ranges of audio.

- **Music Balance** will adjust frequency response that gives the most natural balance between lows, mids, and highs.
- **Music Enhanced** will lower midrange frequencies slightly.
- **Voice** will increase midrange frequencies of the human voice and cut environmental noise for better clarity with voice communication.
- **Bass Boost** will increase the bass range of audio (130 Hz and below).
- **Treble Boost** will increase the high range of audio (6 kHz and above).

14.2.4 Audio Boost (Default: Enable)

Audio Boost increases the overall maximum volume. If **Audio Boost** is enabled, Equalizer will not be effective at the maximum volume and only work below the maximum volume. If **Audio Boost** is disabled, Equalizer will work across all volume ranges.

14.2.5 VOX Phone (Default: Enable)

If this feature is enabled, you can answer incoming calls by voice. When you hear a ringtone for an incoming call, you can answer the phone by saying a word such as **"Hello"** loudly or by blowing air into the microphone. **VOX Phone** is temporarily disabled if you are connected to intercom. If this feature is disabled, you have to tap the **Jog Dial** or the **Phone Button** to answer an incoming call.

14.2.6 VOX Intercom (Default: Disable)

If this feature is enabled, you can initiate an intercom conversation with the last connected intercom friend by voice. When you want to start intercom, say a word such as **"Hello"** loudly or blow air into the microphone. If you start an intercom conversation by voice, the intercom terminates automatically when you and your intercom friend remain silent for **20 seconds**. However, if you manually start an intercom conversation by tapping the **Jog Dial**, you have to terminate the intercom conversation manually. However, if you start the intercom by voice and end it manually by tapping the **Jog Dial**, you will not be able to start intercom by voice temporarily. In this case, you have to tap the **Jog Dial** to restart the intercom. This is to prevent repeated unintentional intercom connections by strong wind noise. After rebooting the headset, you can start intercom by voice again.

14.2.7 VOX Sensitivity (Default: 3)

Vox Sensitivity can adjust the sensitivity of Vox Phone and Vox Intercom. **Level 5** is the highest sensitivity setting and **level 1** is the lowest.

14.2.8 HD Intercom (Default: Enable)

HD Intercom enhances the two-way intercom audio from normal quality to HD quality. **HD Intercom** will become temporarily disabled when you enter into a multi-way intercom. If this feature is disabled, the two-way intercom audio will change to normal quality.

Note:

- The intercom distance of **HD Intercom** is relatively shorter than that of normal intercom.
- **HD Intercom** will become disabled temporarily when **Bluetooth Intercom Audio Multitasking** is enabled.

14.2.9 HD Voice (Default: Enable)

HD Voice allows you to communicate in high-definition during phone calls. This feature increases the quality so that the audio will be crisp and clear during phone call conversations. If this feature is enabled, incoming phone calls will interrupt intercom conversations and audio from the SR10 will not be heard during intercom conversations. **Three-Way Conference Phone Call with Intercom Participant** will not be available if **HD Voice** is enabled.

Note:

- Refer to the manufacturer of your Bluetooth device that will be connected to the headset to see if it supports **HD Voice**.
- **HD Voice** is active only when **Bluetooth Intercom Audio Multitasking** is disabled.

14.2.10 Bluetooth Intercom Audio Multitasking (Default: Disabled)

Audio Multitasking (Bluetooth Intercom Audio Multitasking and Mesh Intercom Audio Multitasking) allows you to have an intercom conversation while simultaneously listening to music, FM radio, or GPS instructions. The overlaid audio is played in the background with reduced volume whenever there is an intercom conversation and will return to normal volume once the conversation is finished.

The **Mesh Intercom Audio Multitasking** feature is **always on**.

Note:

- For **Bluetooth Intercom Audio Multitasking** to work properly, you need to power the headset off and on. **Please restart the headset.**
- **Bluetooth Intercom Audio Multitasking** will be activated during two-way intercom conversations with a headset that also supports this feature.
- Some GPS devices may not support this feature.
- The **Audio Multitasking** feature can be configured through the **Intercom-Audio Overlay Sensitivity** and the **Audio Overlay Volume Management settings**.

14.2.11 Intercom-Audio Overlay Sensitivity (Default: 3)

The music, FM radio and GPS volume will be lowered to play in the background if you talk over the intercom while the overlaid audio is playing. You can adjust the intercom sensitivity to activate this background audio mode. **Level 1** has the lowest sensitivity and **level 5** has the highest sensitivity.

Note: If your voice is not louder than the sensitivity of the selected level, the overlaid audio will not be lowered.

14.2.12 Audio Overlay Volume Management (Default: Disable)

The music, FM radio and GPS overlaid audio reduces in volume whenever there is an ongoing intercom conversation. If **Audio Overlay Volume Management** is enabled, the volume level of the overlaid audio will not be reduced during an intercom conversation.

14.2.13 Smart Volume Control (Default: Disable)

Enabling **Smart Volume Control** automatically changes the level of the speaker volume based on the level of the environment noise. You can enable it by setting the sensitivity to **low**, **medium** or **high**.

14.2.14 Sidetone (Default: Disable)

Sidetone is audible feedback of your own voice. It helps you to naturally speak at the correct level according to varying helmet noise conditions. If this feature is enabled, you can hear what you are speaking during an intercom conversation or a phone call.

14.2.15 Voice Assistant (Default: Enable)

If **Voice Assistant** is enabled, you can wake up Siri or Google Assistant using a voice command, such as "Hey Siri" or "Hey Google." If you do not want to wake up Siri or Google Assistant with your voice, disable this feature.

14.2.16 Voice Prompt (Default: Enable)

You can disable **Voice Prompts** by software configuration settings, but the following voice prompts are always on.

- Headset configuration settings menu, battery level indicator, speed dial, FM radio functions

14.2.17 RDS AF Setting (Default: Disable)

Radio Data System (RDS) Alternative Frequency (AF) Setting allows a receiver to re-tune to the second frequency location when the first signal becomes too weak. With RDS AF enabled on the receiver, a radio station with more than one frequency can be used.

14.2.18 FM Station Guide (Default: Enable)

When **FM Station Guide** is enabled, FM station frequencies are given by voice prompts as you select preset stations. When **FM Station Guide** is disabled, the voice prompts on FM station frequencies will not be given as you select preset stations.

14.2.19 Advanced Noise Control™ (Default: Enable)

When **Advanced Noise Control** is enabled, the background noise is reduced during an intercom conversation. When it is disabled, the background noise is mixed with your voice during intercom.

14.3 Camera Configuration Setting

You can change the settings of the camera through the **Sena Camera App**.



14.3.1 Photo Mode (Default: Single Shot Mode)

You can select the photo mode to be either **Single Shot** or **Burst Shot**. **Single Shot** takes a single photo while **Burst Shot** takes 8 photos.

14.3.2 Video Mode (Default: Normal Recording Mode)

You can select the video mode to be **Normal Recording Mode**, **Timelapse Mode**, or **Loop Recording Mode**. **Timelapse Mode** records series of photos at timed intervals and makes it into a video. **Loop Recording Mode** constantly records videos at timed intervals, replacing old video files when memory is full.

14.3.3 Video Resolution (Default: 2160P/30fps)

You can select the **Video Resolution** to be 2160P/30fps, 1440P/30fps, 1080P/60fps, 1080P/30fps, 1080P/60fps + EIS and 1080P/30fps+EIS.

Note: Electronic image stabilization (EIS) is an image enhancement technique using electronic processing. EIS minimizes blurring and compensates for camera shake.

14.3.4 Timelapse Interval (Default: 1 sec)

You can select the **Timelapse Interval** to be **1 second**, **2 seconds**, **5 seconds** or **10 seconds**.

14.3.5 Video Microphone Gain (Default: Medium)

You can select the **Microphone Gain** for video recording to be **low**, **medium**, or **high**.

14.3.6 Date Caption (Default: Off)

You can record or hide **Date Caption** during video recording. If you select on, the date caption will be displayed on top of your recorded video. If you select off, the date caption will not be shown on your recorded video.

14.3.7 Smart Audio Mix (Always On)

Smart Audio Mix allows you to record everything you hear through your speakers as well as your voice during video recording. The function that governs **Smart Audio Mix** is called **Speaker Sound Recording**.

14.3.8 Auto Camera Sleep (Default: On)

You can set the camera to automatically power off after 5 minutes of inactivity. This feature does not work while charging the camera.

14.3.9 Format SD Card

SD card format will remove all files from a microSD card. When you use a new card for the first time, always format it before using the camera.

15. TROUBLESHOOTING

Please visit [sena.com](https://www.sena.com) for more troubleshooting information.

15.1 Fault Reset

When the headset is not working properly, you can easily reset the unit:

1. Locate the **Pinhole Fault Reset Button** at the back of the headset main unit.
2. Gently insert a paperclip into the hole and tap the **Pinhole Fault Reset Button** with light pressure.

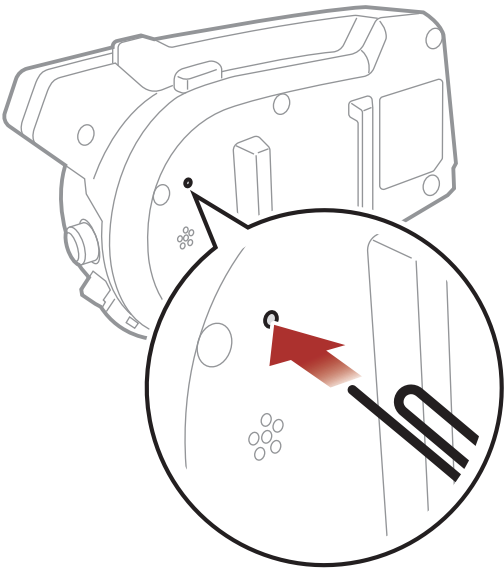









3. The headset will shut down.

Note: Fault Reset will not restore the headset to factory default settings.

15.2 Factory Reset

To erase all of your settings and start fresh, the headset can be restored to factory default settings using the **Factory Reset** feature.

1.  =   →  "Factory reset"
2.  =   →  "Headset reset, good-bye"

15.3 The Camera's Warning

15.3.1 Memory is Full

When the memory is full



→ Please format the SD card.

15.3.2 No microSD Card

If no microSD card is inserted in the microSD card slot



→ Please insert the microSD card before use.

15.3.3 microSD Card Error

If an error occurs on the microSD card

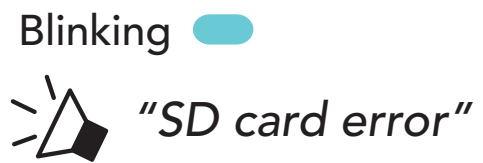

→ Please check the microSD card.

15.3.4 High Temperature

If the camera system becomes too hot



→ Cool down the camera before further use.



Copyright 2025 Sena Technologies, Inc.
All rights reserved.

© 1998–2025 Sena Technologies, Inc. All rights reserved.

Sena Technologies, Inc. reserves the right to make any changes and improvements to its product without providing prior notice.

Sena™ is a trademark of Sena Technologies, Inc. or its subsidiaries in the USA and other countries. SF1™, SF2™, SF4™, SFR™, SRL™, SRL2™, SRL3™, SRL-EXT™, SRL-Mesh™, Momentum™, Momentum INC™, Momentum Lite™, Momentum Pro™, Momentum INC Pro™, Momentum EVO™, Cavalry™, CAVALRY 2™, Latitude SR™, Latitude SX™, Latitude S1™, 30K™, 33i™, 60S™, 50S™, 50R™, 50C™, 5S™, 5R™, 5R LITE™, 20S EVO™, 20S™, 10S™, 10C™, 10C PRO™, ProRide EVO™, 10C EVO™, 10U™, 10Upad™, 10R™, ACS10™, ACS-RAM™, BiKom 20™, B10™, B20™, E30™, J30™, C1™, C10™, C20™, CAST™, 3S™, 3S PLUS™, SMH5™, SMH5-FM™, SMH5 MultiCom™, SMH10™, SMH10R™, SPH10™, SPH10H-FM™, Savage™, Prism Tube WiFi™, Prism™, Bluetooth Audio Pack for GoPro®, IMPULSE™, FURY™, R1™, R1 EVO™, R1 EVO CS™, R2™, R2 EVO™, R2X™, M1™, M1 EVO™, S1™, RUMBA™, RC1™, RC3™, RC4™, STRYKER™, Handlebar Remote™, Wristband Remote™, PHANTOM™, PowerPro Mount™, Powerbank™, FreeWire™, WiFi Docking Station™, WiFi Sync Cable™, WiFi Adapter™, +mesh™, +Mesh Universal™, MeshPort Blue™, MeshPort Red™, MeshPort Black™, Econo™, OUTLANDER M™, OUTRUSH™, OUTRUSH R™, OUTSTAR™, OUTSTAR S™, OUTFORCE™, OUTRIDE™, OUTRUSH M™, EcoCom™, Parani A10™, Parani A20™, Parani M10™, pi™, Snowtalk™, Snowtalk2™, SR10™, SR10i™, SM10™, SPIDER RT1™, SPIDER ST1™, SURGE™, TALKIE™, U1™, X1™, X1 Pro™, X1S™, EXPAND™, EXPAND BOOM™, EXPAND MESH™, Bluetooth Mic & Intercom™, Tufftalk™, Tufftalk Lite™, Tufftalk M™, NAUTITALK Bosun™, NAUTITALK N2R™ are trademarks of Sena Technologies, Inc. or its subsidiaries. These trademarks may not be used without the express permission of Sena.

GoPro® is a registered trademark of Woodman Labs of San Mateo, California. Sena Technologies, Inc. ("Sena") is not affiliated with Woodman Labs, Inc. The Sena Bluetooth Pack for GoPro® is an aftermarket accessory specially designed and manufactured by Sena Technologies, Inc. for the GoPro® Hero3 and Hero4 allowing for Bluetooth capabilities.

The Bluetooth® word mark and logos are owned by the Bluetooth SIG, Inc. and any use of such marks by Sena is under license. iPhone® and iPod® touch are registered trademarks of Apple Inc.

Sena Technologies, Inc.
152 Technology Drive, Irvine, CA 92618